

The Auckland Code of Practice for Land Development and Subdivision

Chapter 3:

Transport

April 2022

Draft Version 1



The Auckland Code of Practice for Landscaping and Development

Chapter 3: Transport

April 2022

Auckland Council

Auckland Council disclaims any liability whatsoever in connection with any action taken in reliance of this document for any error, deficiency, flaw or omission contained in it.

This document is licensed for re-use under the [Creative Commons Attribution 4.0 International licence](https://creativecommons.org/licenses/by/4.0/).



Document control

Document name	Auckland Code of Practice for Land Development and Subdivision Chapter 3: Transport
---------------	--

Purpose	The purpose of this chapter is to provide minimum standards for developers for the design and construction of new public road assets and of new assets which are to be vested in Auckland Council ownership.
---------	--

Version history

Version	Date
Draft	April 2022

Approval for Version 1.0

Reviewed and recommended for publication	Chris Beasley, Design and Standards Manager, Auckland Transport
Approved	Murry Burt, Chief Engineer, Auckland Transport

Acknowledgements

Thanks to the Transport Code of Practice chapter working group: Andy Irwin, Twan Van Duivenbooden, Richard Westerman, Arvind Lal, Jared Plumridge, Irene Tse.

Special thanks go to Steve Cavanagh, Vinh Bui, Seth Sirestarajah, Branko Veljanovski who contributed to the development of this Code of Practice by sharing their expertise with the working group.

Thanks are also extended to all other Auckland Council and Auckland Transport staff, both past and present, who attended workshops, reviewed and contributed to the development of the Transport Code of Practice.

Feedback

Please email transportdesignmanual@at.govt.nz with your comments and suggestions.

Table of Contents

3.0	Transport	1
3.1	General	1
3.1.1	Objectives	1
3.1.2	Auckland Transport – Transport design manual.....	1
3.1.3	Departure from Standards – Alternative design and Products	2
3.2	Street design	3
3.2.1	Design principles	3
3.2.2	Network planning and design	4
3.2.3	Road widths	5
3.2.4	Road element design.....	12
3.3	Urban and rural roadway design	13
3.3.1	Design parameters	13
3.3.2	Geometric alignment.....	18
3.3.3	Camber, cross-fall and super-elevation	19
3.3.4	Standard road configuration	20
3.3.5	Kerb and channel.....	25
3.3.6	Vehicle crossings	28
3.3.7	Intersection design & types.....	29
3.4	Footpaths and the public realm	32
3.4.1	Road and street zones.....	32
3.4.2	Footpaths and pedestrian facilities	35
3.4.3	Trees and planting	47
3.4.4	Street furniture	50
3.4.5	Utilities and services	60
3.5	Cycling and infrastructure	63
3.5.1	Choosing the right facility.....	63
3.5.2	Approved facilities within the road reserve	64
3.5.3	Other infrastructure	68
3.5.4	Off road cycle paths	70
3.5.5	Intersections.....	71
3.5.6	Kerbside activity.....	75
3.5.7	General design.....	77
3.5.8	Ancillary features	86

3.5.9	Appendix A Cycle parking.....	88
3.6	Public transport – Bus infrastructure.....	93
3.6.1	Design parameters	93
3.6.2	Movement or upgrading of bus stops	100
3.6.3	Bus stop location	101
3.6.4	Bus stop layout	109
3.6.5	Bus stop signs and markings.....	118
3.6.6	Bus stop types	120
3.6.7	Bus stop elements	125
3.6.8	Bus stop passenger area.....	130
3.6.9	Bus shelters	132
3.6.10	Landscaping.....	139
3.6.11	Passenger information.....	139
3.6.12	Bus stop lighting	140
3.6.13	Cycleways at bus stops	141
3.7	Traffic calming	144
3.7.1	Use of traffic calming devices.....	144
3.7.2	Planning the use of traffic calming.....	144
3.7.3	Vertical traffic calming devices	147
3.7.4	Horizontal traffic calming devices	150
3.7.5	Volume reduction devices.....	151
3.7.6	Signs and visual effects	152
3.7.7	Entry/gateway treatments	153
3.7.8	Traffic calming on bus routes.....	153
3.8	Parking and design.....	155
3.8.1	Design philosophy	155
3.8.2	Mobility parking.....	156
3.8.3	Motorcycle parking.....	156
3.8.4	Cycle parking	157
3.8.5	Loading zones.....	157
3.8.6	Special parking	157
3.9	Pavement and surfacing	158
3.10	Geotechnical and structural design	159
3.11	Road drainage	160
3.11.1	Design principles	161
3.11.2	Surface water management.....	167
3.11.3	Stormwater treatment devices: Road drainage	168

3.11.4	Kerbs and channels	172
3.11.5	Catchpits and continuous inlets	173
3.11.6	Manholes	178
3.11.7	Rural road drainage	178
3.11.8	Subsoil drains	179
3.11.9	Minor culverts.....	180
3.11.10	Special areas	181
3.12	Street lighting.....	182
3.12.1	Applicable standards	182
3.12.2	Lighting design.....	183
3.12.3	Lighting columns	186
3.12.4	Luminaires	188
3.12.5	Road lighting in specific areas	190
Appendices	191
Appendix A:	Swept path graphs for design vehicles	192
Appendix B:	Auckland Transport TDM supporting appendix documents	197
Appendix C:	Glossary	198
Appendix D:	Relevant documents	205

Tables

Table 1:	Standard street types	5
Table 2:	Design vehicles.....	14
Table 3:	Design vehicles for street types.....	15
Table 4:	Tracking type	16
Table 5:	Acceleration rate.....	18
Table 6:	Speed environment >50 km/h	20
Table 7:	Speed environment 50 km/h or less	21
Table 8:	Flush median widths	22
Table 9:	Acceptable road shoulder widths.....	23
Table 10:	Kerb type according to situation	25
Table 11:	Channel types.....	27
Table 12:	Minimum footpath zone dimensions	35
Table 13:	Minimum rural footpath zone dimensions.....	36
Table 14:	Footpath gradients.....	37

Table 15: Auckland Transport – Acceptable pedestrian surface materials	38
Table 16: Slip resistance coefficients for pedestrian surfaces	40
Table 17: Preferred permanent benches, seats and tables (fixed)	51
Table 18: Preferred seats, benches and tables moveable	52
Table 19: Preferred shade structures: Fixed	53
Table 20: Preferred shade structures: Flexible.....	54
Table 21: Preferred bollard designs	59
Table 22: Cycle parking and manoeuvring at low speeds: Minimum dimensions.....	63
Table 23: Criteria for separated cycleways (busy, fast or heavy traffic).....	64
Table 24: Criteria for separated cycleway (low volume and slow traffic)	66
Table 25: Interim facility dimensions	68
Table 26: Width of buffered cycle lane	68
Table 27: Width of kerbside cycle lane.....	69
Table 28: Width of cycle lane between other lanes	69
Table 29: Width of shared path	69
Table 30: Horizontal curves.....	79
Table 31: Gradients	80
Table 32: Thresholds for number of files	82
Table 33: Cycle envelope widening.....	83
Table 34: Edge clearances.....	83
Table 35: Bicycle parking basic dimensions.....	91
Table 36: Bus stop spacing guidance.....	102
Table 37: Bus stop types	120
Table 38: Infrastructure provision for different bus stop types	126
Table 39: Percentage speed reduction due to bend	146
Table 40: Maximum spacing of devices for speed environments	147
Table 41: Vertical traffic calming device design standards for non-bus routes	148
Table 42: Vertical traffic calming device design standards for bus routes	154
Table 43: Parking space and manoeuvring dimensions in metres.....	155
Table 44: Typical dimensions for trucks	157
Table 45: Serviceability (10% AEP) allowable spread widths and channel flows – Traffic lanes	164
Table 46: Serviceability (10% AEP) allowable spread widths and channel flows – Road types.....	164
Table 47: Major event – roadway flow limitations.....	166
Table 48: Treatment and management options	169

Table 49: Allowance for inlet blockage 175

Table 50: Typical use of catchpit types 176

Table 51: Lighting design submission checklist 184

Figures

Figure 1: Application of curve widening 21

Figure 2: Clearway use by people on bikes with parking during off-peak periods 22

Figure 3: Dropped footpath for steep driveway 28

Figure 4: Urban street zones 32

Figure 5: Suburban and rural street zones 33

Figure 6: Rural street zones 34

Figure 7: Tree with definition labels 48

Figure 8: Approved design option 1 64

Figure 9: Approved design option 2 65

Figure 10: Separator with parking 65

Figure 11: Approved design option 3 66

Figure 12: Approved design option 4 66

Figure 13: Cycleway through a pedestrian street or plaza 67

Figure 14: Paired crossing- one-way traffic 73

Figure 15: Paired crossing - two-way traffic 74

Figure 16: Surface treatment at vehicle crossing 74

Figure 17: Bicycle marking layout 75

Figure 18: Full island bus stop 75

Figure 19: Partial island design 76

Figure 20: Boarding stop 76

Figure 21: Lateral clearances on horizontal curves 78

Figure 22: Approach clear space – driver gives way to cyclist 79

Figure 23: Approach clear space – cyclist gives way to driver 79

Figure 24: Gradient changes 81

Figure 25: Example of file width considerations 82

Figure 26: Edge clearance 84

Figure 27: Kerb profile 84

Figure 28: Cycle lane symbol86

Figure 29: Path termination bollards.....87

Figure 30: Basic bicycle dimensions88

Figure 31: Adaption of a Sheffield stand for children’s bicycles.....89

Figure 32: Bicycle stands alignment in relation to the slope89

Figure 33: Indicative bicycle corral89

Figure 34: Long-term bicycle parking (for double sided stands, Sheffield only) layout for 16 cycles.....90

Figure 35: Sheffield bicycle stand dimensions. Left: surface mounted. Right: in ground.....90

Figure 36: Required direct concrete embedment for a bicycle stand.....91

Figure 37: Harrogate bicycle stand dimensions. Left: surface mounted. Right: in ground.....91

Figure 38: Indicative layout for bicycle parking92

Figure 39: Typical 13.5 m AT Metro bus93

Figure 40: Typical 12.6 m AT Metro double-decker bus94

Figure 41: Standard bus body width.....94

Figure 42: Clearance from soft obstacles (such as trees).....95

Figure 43: Clearance from hard obstacles (such as building canopies verandas and shelters).....95

Figure 44: Horizontal gaps, ramp gradient and step height98

Figure 45: Good practice principles for bus stop spacing and location.....104

Figure 46: Good practice principles for bus stop spacing and location.....104

Figure 47: Tail-to-tail bus stop layout105

Figure 48: Bus stop crossroad placement.....108

Figure 49: Failure to align bus properly and pull in at a sharp angle.110

Figure 50: Kerbside bus stop with parking either side for a standard 13.5 m long tag-axle bus.....111

Figure 51: Kerbside bus stop with parking on either side for two standard 13.5 m long tag-axle buses111

Figure 52: Kerbside bus stop with parking either side for a standard 13.5 m long tag-axle bus.....112

Figure 53: Kerbside bus stop on exit side of an intersection.....112

Figure 54: Full-width bus boarder for a single standard 13.5 m long tag-axle bus112

Figure 55: Full width bus boarder for two standard 13.5 m long tag-axle buses.....113

Figure 56: Half-width bus boarder for a single standard 13.5 m long tag-axle bus.....114

Figure 57: Half-width bus boarder – (Alternative 1) for retrofit to existing street kerblines114

Figure 58: Half-width bus boarder – (Alternative 2) for retrofit to existing street kerblines115

Figure 59: Fully indented bus bay for a standard 13.5 m long tag-axle bus117

Figure 60: Fully indented bus bay for two standard 13.5 m long tag-axle buses117

Figure 61: Half-indented bus bay for a standard 13.5 m long tag-axle bus117

Figure 62: Sign and marking layout for bus stop up to 29 m 118

Figure 63: Sign and marking layout for bus stop longer than 29 m..... 118

Figure 64: Bus stop sign (RP-5) 118

Figure 65: Typical Bus box marking 119

Figure 66: Bus box with coloured surface treatment 120

Figure 67: Schematic illustration of a Signature stop 122

Figure 68: Schematic illustration of a Regular bus stop 122

Figure 69: Schematic illustration of a Cantilever Shelter bus stop 123

Figure 70: Schematic illustration of a no shelter bus stop 123

Figure 71: Schematic illustration of a Standard bus stop 124

Figure 72: Layout for a standard kerbside bus stop at a constrained site..... 125

Figure 73: Layout for a standard kerbside bus stop with a wide divided pedestrian route 125

Figure 74: Small gap between the kerb and bus floor make it easy for passengers to board or alight 128

Figure 75: Standard and Kassel kerb profiles 129

Figure 76: Recommended layout for tactile ground surface indicators at bus stops 131

Figure 77: Bus shelter layout 1 134

Figure 78: Bus shelter layout 2 134

Figure 79: Bus shelter layout 3 135

Figure 80: Minor shelter example 136

Figure 81: Intermediate shelter example 137

Figure 82: Major shelter example 137

Figure 83: Example cycle parking at bus stops 138

Figure 84: A bus stop information sign 139

Figure 85: Full island design (Preferred) 142

Figure 86: Partial island design 142

Figure 87: Boarding strip design..... 143

Figure 88: Correlation between visibility and carriageway width and vehicle speeds..... 145

Figure 89: Car parking layout 156

Figure 90: Semi-recessed catchpit 176

3.0 Transport

3.1 General

3.1.1 Objectives

The purpose of this chapter is to provide minimum standards for developers for the design and construction of new public road assets and of new assets which are to be vested in Auckland Council ownership.

In the event that these minimum standards are not achievable, developers shall discuss alternative approaches to development and ownership with Auckland Council. Auckland Council requires that any vested assets are safe to maintain, operate and decommission.

Design and construction of transport infrastructure that is to be vested as public road or other Auckland Transport assets is to comply with the *Auckland Code of Practice for Land Development and Subdivision – Chapter 1: General Requirements and Chapter 3: Transport*.

In addition, further requirements are set out below in this section.

3.1.2 Auckland Transport – Transport design manual

The Transport Design Manual (TDM) is a set of guides, codes and specifications that are specifically created for the Auckland region to provide designers with the tools necessary to produce soundly engineered roading infrastructure to a standard acceptable to Auckland Transport.

It is published on Auckland Transport website: <https://at.govt.nz/about-us/manuals-guidelines/transport-design-manual>.

The TDM includes various documents which this Code requires to be used in design:

Section 1: Design guidance	All infrastructure design must use the Guides that apply to the specific context.
Section 2: Detailed Technical Requirements	<p>Engineering Design Code:</p> <ul style="list-style-type: none"> • These documents provide the minimum standards and detailed instruction in roading design for all public road to be created and vested to Council. • Note: The Engineering Design Code – Pavements and surfacing is currently being prepared. The current Auckland Transport pavement design document is the <i>Auckland Transport Code of Practice (2013) Chapter 16: Road Pavements and Surfacing</i>. <p>Standard Engineering Details:</p> <ul style="list-style-type: none"> • The drawings and details published should be used for all public road infrastructure. • Details may be varied to meet specific design requirements, but if varied, they must still comply with this Code.

	<p>Design Tools:</p> <ul style="list-style-type: none"> • Further aids to design, including standard Auckland Transport Design Vehicle templates, will be published to assist designers. Designs using them will be deemed to comply with this Code when used appropriately.
Section 3: Specifications for Transport Infrastructure	<p>Specifications published in the TDM must be used. Current publications include:</p> <ul style="list-style-type: none"> • Series 0800 – Specifications for the Supply of Aggregate

References in this document to the Standard Engineering Details are in the form: AT TDM SED XX0000.

3.1.3 Departure from Standards – Alternative design and Products

This Code does allow that alternative designs may be considered due to land access, topographical or other physical constraints. In any application for Engineering Approval, where a deviation from the standards is sought, the application must clearly identify the items of the Code from which Departure is sought. It must include the reasons for Departure, assessment of safety and effectiveness, alternatives considered and why they are not chosen, and any mitigation measures and monitoring required.

Any new product or material that does not comply with stated standards or Standard Engineering Details must be submitted with supporting technical data and test results prior to approval for use. Approval under a Departure from Standard may be given for alternative products or materials. On completion of a trial or pilot, products or materials may be approved for use in specified circumstances or in general.

Approval in principle can be requested early in the design process, but approval in detail must be obtained before a design can be finally approved.

Approval can only be granted by the Auckland Transport Chief Engineer or their delegate, provided Auckland Council's Regulatory requirements have satisfactorily been met.

3.2 Street design

3.2.1 Design principles

These principles are explained in full in the Auckland Transport *Urban street and road design guide* in Section 1 of the TDM <https://at.govt.nz/about-us/manuals-guidelines/transport-design-manual>.

All of the principles are to be applied to all network planning and road design covered by this Code, although the application of each will be at a scale appropriate to the scale of the works proposed.

The standards in this chapter are set to enable designs that meet these principles. Designs are to be assessed for compliance with the principles:

<p>DESIGN FOR PEOPLE</p> <p>People are the basic design unit for cities and liveable streets.</p>	<p>DESIGN FOR SAFETY</p> <p>The safety of all street users, especially the most vulnerable users (children, the elderly, and disabled) and modes (pedestrians and cyclists) should be paramount in any street design.</p>	<p>DESIGN FOR CONTEXT</p> <p>Streets are expected to reflect and support adjacent land uses. Well-designed streets promote appropriate speeds, modes and footpath activities.</p>
<p>STREETS INFLUENCE OUR HEALTH</p> <p>Street designs can help people make healthy decisions by supporting walking, cycling and public transport. Street and neighbourhood design play a role in how people move around safely, in their exercise and activity levels, and personal wellbeing.</p>	<p>STREETS AS ECOSYSTEMS</p> <p>Green infrastructure can retain and reduce stormwater. Green infrastructure brings nature into the city, which can improve both mental and physical health, increase amenity, improve air quality, conserve energy, and enhance habitat in urban areas that are increasingly intensified.</p>	<p>TE ARANGA PRINCIPLES</p> <p>Te Aranga Māori Design Principles are founded on intrinsic Māori cultural values. They have arisen from a widely held desire by Māori to enhance their presence, visibility and participation in the design of the physical realm.</p>
<p>STREETS ARE PUBLIC SPACE</p> <p>Street design should encourage and enable recreation, social interaction and business activity and create an attractive, comfortable, pedestrian-scale environment with a range of amenities, including street trees and other vegetation.</p>	<p>BETTER STREETS ARE GREAT FOR BUSINESS</p> <p>Improved accessibility and a more welcoming street environment attract more people and more activity, thus strengthening communities, the businesses that serve them and the overall city economy.</p>	<p>STREETS IMPACT OUR QUALITY OF LIFE</p> <p>Streets influence our ability to move around, connect to wider transport networks and access the opportunities of the city. Streets also shape our local environment and neighbourhoods.</p>
<p>STREETS ARE MULTI-MODAL</p> <p>Street design must support safe, comfortable and attractive multi-modal transport for all users, including elderly, children and mobility-impaired users. Any particular street may have a different mix of modes to achieve these network objectives.</p>	<p>STREETS CAN CHANGE</p> <p>Streets can change through major interventions and capital improvement projects, and they can also change systematically through road renewals and ongoing maintenance. Street designs can also be strategically implemented through quick, low-cost interventions that can serve as interim stages to more long-term visions.</p>	<p>STREETS CARRY PEOPLE AND GOODS</p> <p>Productivity of movement of people should be ensured. Movement of freight and servicing land uses must be balanced with the ways people move in the street.</p>

3.2.2 Network planning and design

Roads, streets, cycle paths and walkways, including rights of way over public or private land, must be laid out to form part of a connected strategic transport system. The following Auckland Transport documents, processes and strategies should be used.

Where changes to the Transport Network are proposed for development, the Designer must seek guidance from Auckland Transport and by the following:

- Pre-application meeting
- Resource consent application
- Engineering plan approval application.

3.2.2.1 Network planning context

Information should be obtained from Auckland Transport for:

- Planned network changes (Future Connect)
- Current network operating plans
- Current and planned public transport services.

These should be used to determine the strategic network function requirements for existing and proposed transport system infrastructure.

3.2.2.2 Network design context

TDM Design Guides, especially the *Urban streets and roads design guide*, must be used to identify street types and intersection types that give effect to the functions identified from network planning. Street types are described in Section 3.2.3.1.

3.2.2.3 Detailed design

The design and construction of transport infrastructure must be appropriate for the street and intersection types identified from the planning and design contexts.

Alterations to existing streets and designs for new streets must enable the planned networks to be developed either immediately or over a planned period but must not hinder development of any planned network infrastructure.

3.2.3 Road widths

The road reserve widths given here will generally be appropriate for the street types described, with the elements shown for each. In all cases, some variation in width may be needed to deal with existing constraints, such as stream crossings, embankments or cuttings.

The TDM Design Guides will indicate the elements that will be required in any street, both above and below ground. This section will determine the space that is required for each of the street elements, which can affect the overall width required for a satisfactory design.

Local widening or splays may be required to form intersections. It may be possible to reduce widths away from intersections, subject to specific design.

3.2.3.1 Street types

Auckland Transport's *Roads and streets framework* (RASF) defines functional street typologies, based on the significance of movement and place in them. Nine urban and three rural typologies are defined, from P1/M1 to P3/M3.

The *Urban street and road design guide* and other guides then enable design of the elements appropriate to the functional requirements of these typologies. Names are given to the principal street types, to identify the design responses to the functional typologies. The RASF typologies are included for reference in these.

Various sub-types are also described in the design guides, where specific functional requirements modify the form of the standard types significantly. These may require case-specific concept design to determine the appropriate road width.

Certain road categories are defined in the Auckland Unitary Plan (AUP). These are given for convenience, as AUP rules refer to them.

Standard types are given in Table 1.

Table 1: Standard street types

RASF Typology	P3	P2	P1	Rural	Category
M3	Main Street Arterial	Mixed Use Arterial	Single Use Arterial	Rural Arterial	Arterial
M2	Main Street Collector	Mixed Use Collector	Neighbourhood Collector	Rural Collector	Collector
M1	Centre – Plaza/Square/Shared Space	Centre – Local Street	Local Street	Rural Local Road	Local

Main Street Arterial **M3/P3**



WIDTH Generally 28 m

PLACE

Serving high quality civic, commercial, retail and hospitality. Provision for people to pass through or linger in large numbers. Access for service and delivery may be required at times. Some parking may be present.

MOVEMENT

People on foot. Public transport either within the street or close by. Cycle access or through movement. Vehicle traffic in excess of 10,000 vpd or bus priority may require additional lanes.

SPEED 30 km/h

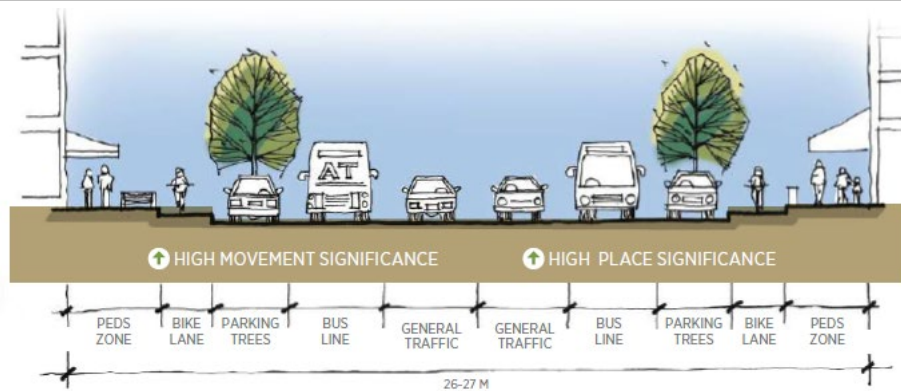

Main Street Collector **M2/P3**



WIDTH Generally 24 m

PLACE

Serving high quality civic, commercial, retail and hospitality in main, local and neighbourhood centres. Provision for people to pass through or linger in moderate to large numbers. Access for service and delivery often required. Parking may be present.

MOVEMENT

People on foot. Public transport either within the street or close by. Cycle access or through movement. Vehicle traffic about 3,000 vpd generally.

SPEED 30 km/h

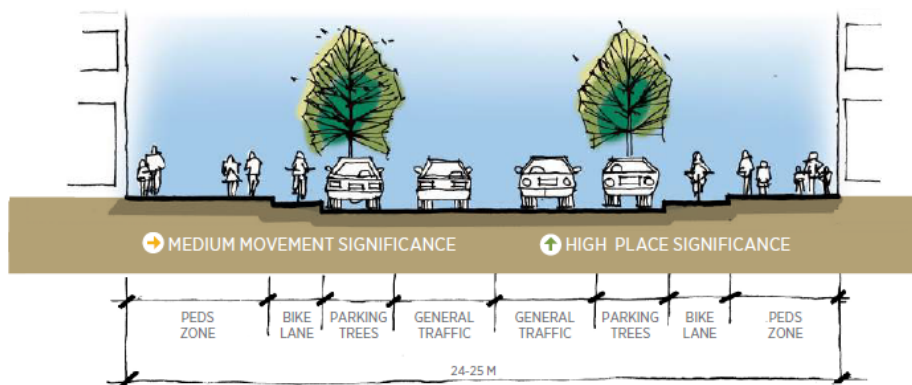

Centre – Plaza/Square/Shared Space **M1/P3**



WIDTH Minimum 12 m. Increased to enable public activity or significant service and delivery.

PLACE

Serving high quality public places, civic, commercial or residential, promenades. Provision for people to pass through or linger in large numbers. Access for service and delivery may be required at times.

MOVEMENT

People on foot or cycle.

Vehicle traffic movement either limited to access or prohibited.

SPEED 10 km/h

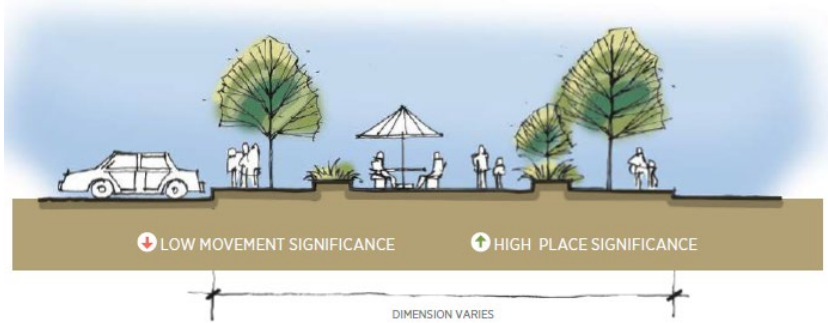

Mixed Use Arterial **M3/P2**



WIDTH Generally 30 m

PLACE

Serving offices, apartments or terraces, education, some retail. Provision for people to pass through in large numbers. Access for service and delivery may be required at times, but preferably off-street.

MOVEMENT

People on foot accessing nearby land use and public transport. Public transport within the street. Cycle through movement and access.

Vehicle traffic in excess of 10,000 vpd or bus priority may require additional lanes.

SPEED 50 km/h (40 km/h in centres)

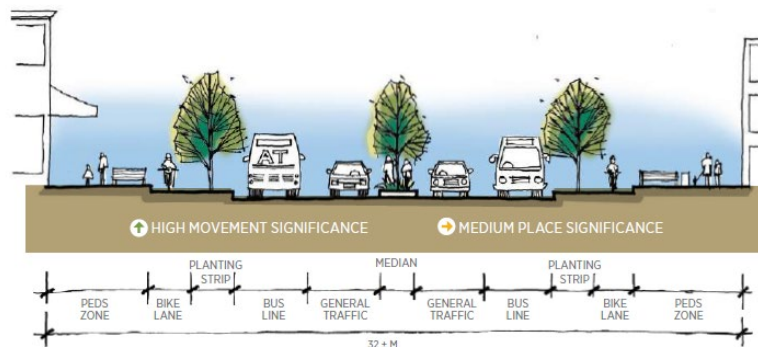

Mixed Use Collector **M2/P2**

WIDTH Generally 22 m

PLACE

Serving offices, apartments or terraces, education, some retail. Provision for people to pass through in moderate numbers. Access for service and delivery and some public parking.

MOVEMENT

People on foot accessing nearby land use and public transport. Public transport within the street. Cycle through movement and access.

SPEED 40 km/h

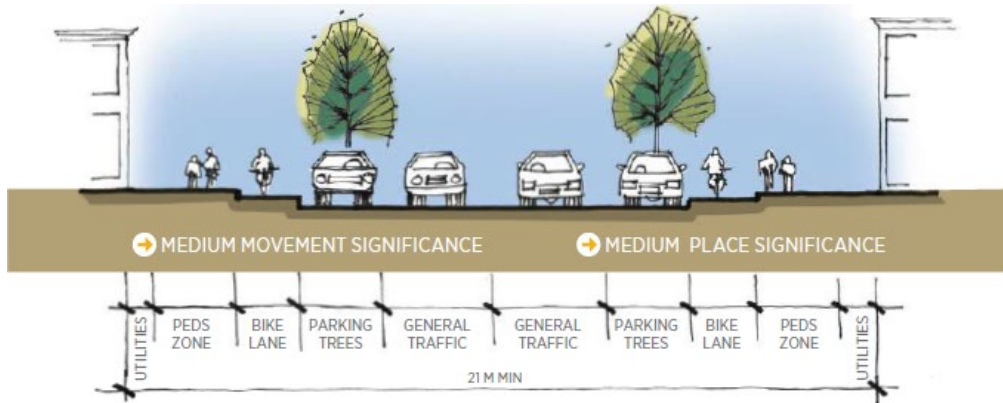

Centre – Local Street **M1/P2**

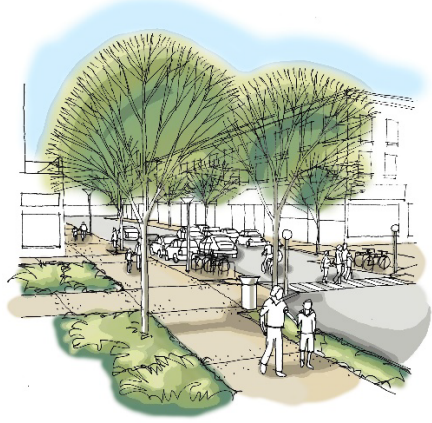

WIDTH Generally 20 m

PLACE

Serving offices, apartments or terraces, hospitality, retail. Provision for people to pass through in moderate to large numbers. Access for service and delivery. Public parking may be present.

MOVEMENT

People on foot accessing nearby land use and public transport. Cycle through movement and access.

SPEED 30 km/h

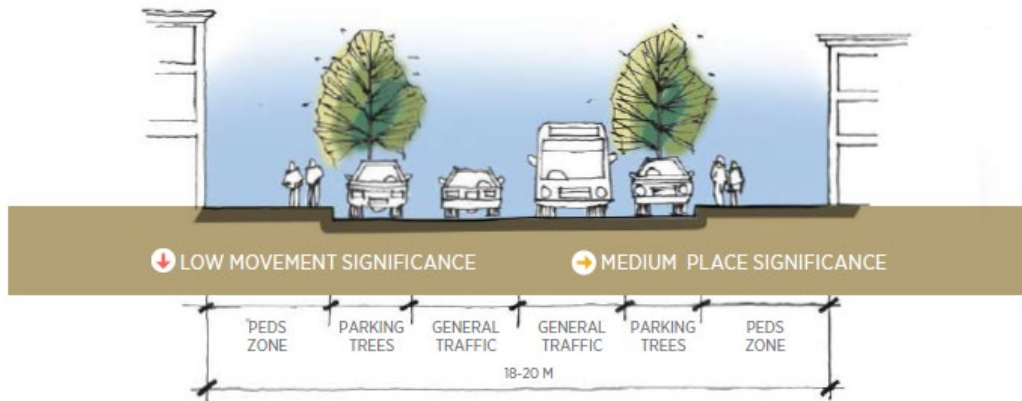

Single Use Arterial **M3/P1**



PLACE

Serving commercial, residential, education, or large-format retail. Provision for people to pass through in large numbers.

MOVEMENT

People on foot accessing nearby land use and public transport. Public transport within the street. Cycle through movement and access. Vehicle access to be provided from other streets directly or via private accessways. Vehicle traffic in excess of 10,000 vpd or bus priority may require additional lanes.

SPEED 50 km/h

WIDTH Generally 30 m

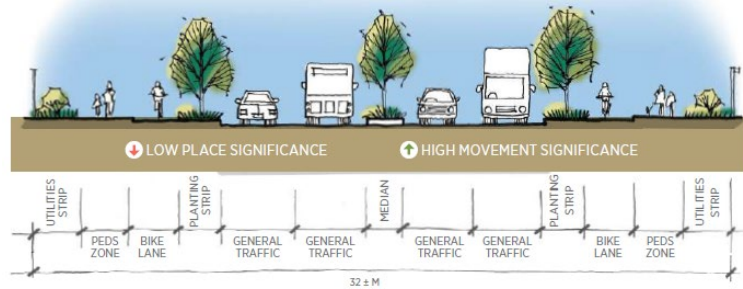

Neighbourhood Collector **M2/P1**



PLACE

Serving offices, residential, education or large-format retail. Provision for people to pass through in moderate numbers. Access for service and delivery at times. Parking may be present.

MOVEMENT

People on foot accessing nearby land use and public transport. Public transport within the street or nearby. Cycle through movement and access. Vehicle traffic in excess of 5,000 vpd or bus priority may require additional lanes.

SPEED 40 km/h

WIDTH Generally 22 m

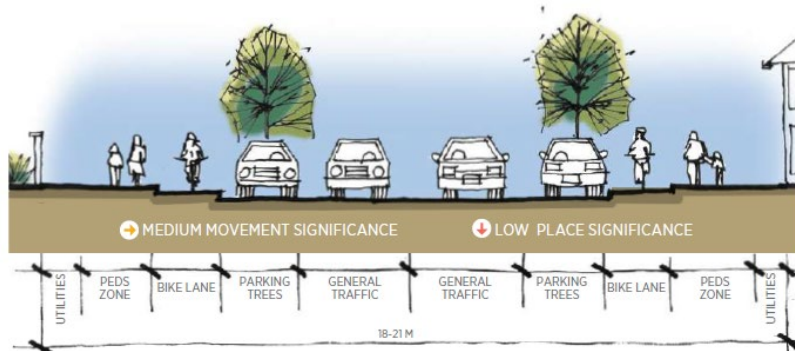

Local Street **M1/P1**

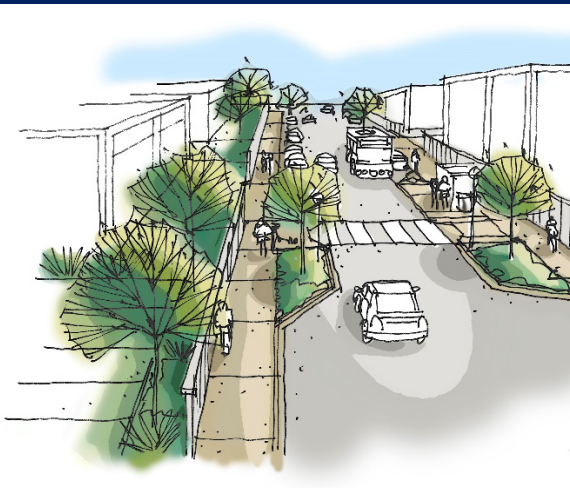

INDUSTRIAL PLACE

Serving manufacture, warehousing and freight distribution, with some large-format retail and offices. Provision for people to access employment by all modes. Access for service and delivery may be required at times, but preferably off-street. Some parking for cars and trucks while awaiting access, loading or visiting.

MOVEMENT

People on foot accessing nearby land use. Public transport nearby. Cycle through movement and access for employees.

Roadway width increased to enable vehicle crossings for trucks to be safe and compact.

SPEED 30 km/h

WIDTH Generally 20 m

RESIDENTIAL PLACE

Serving houses, apartments or terraces, education, some retail. Provision for people to access homes and enjoy streets as public space. Parking generally required. Vehicle crossings to properties must be managed to avoid dominating the street and leaving inadequate space for parking and safe movement. Access for service and delivery is required on street.

MOVEMENT

People on foot accessing nearby land use and public transport. Cycle through movement and access. Access for service and delivery.

Vehicle traffic should not exceed 1,000 vpd.

SPEED 30 km/h

WIDTH Generally 18 m

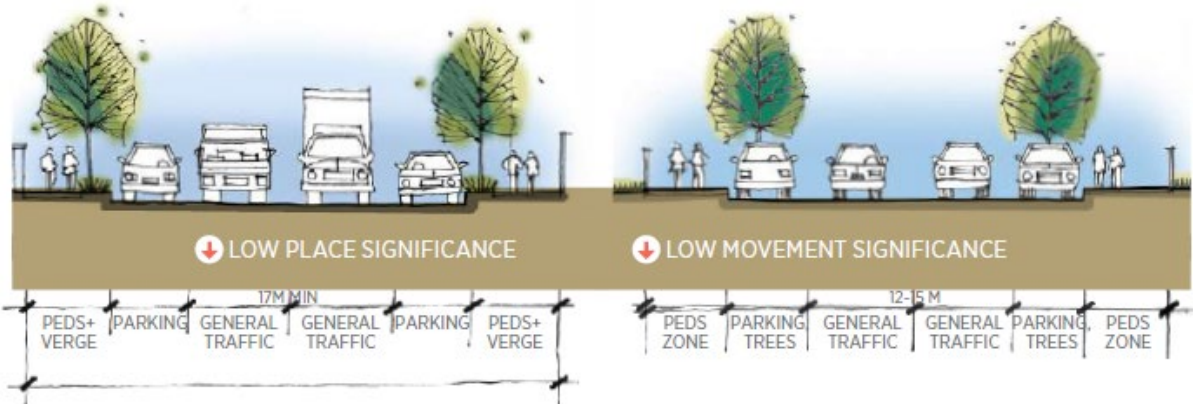

Rural Arterial **M3/PR**

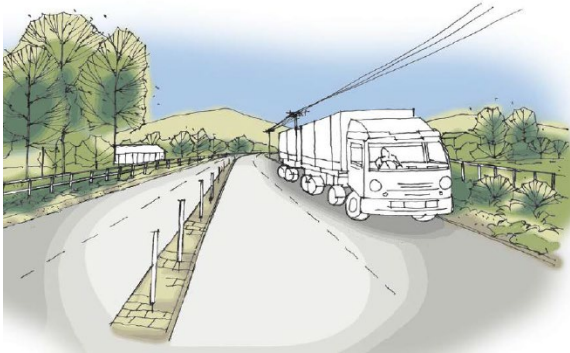

PLACE

Serving rural land uses with minimal direct access while protecting the natural environment. Access to rest areas at intervals. Provision for land drainage often required.

MOVEMENT

Long distance vehicle traffic predominant. People on foot accessing school transport. Public transport within the road. Cycle through movement and access may be present. Limited access to land uses. Vehicle traffic in excess of 5,000 vpd may require additional lanes.

SPEED 80 or 100 km/h, reduced at schools and settlements.

WIDTH Generally 20 m

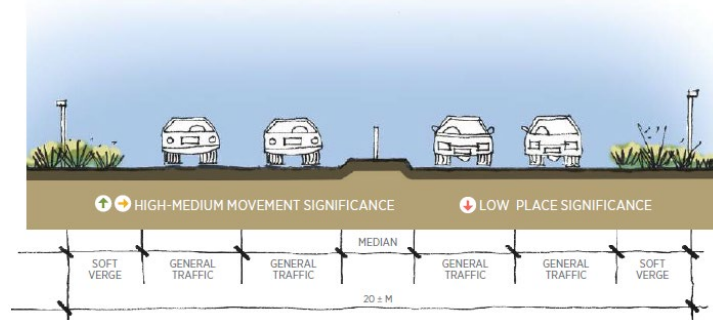

Rural Collector **M2/PR**

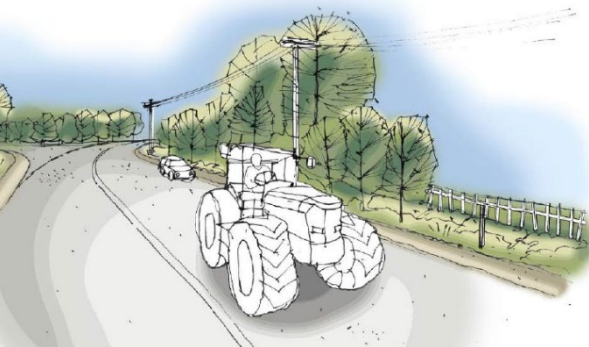

PLACE

Serving rural land uses with direct access while protecting the natural environment. Provision for land drainage often required. Likely to front schools and settlements.

MOVEMENT

People on foot or cycle accessing nearby land use and public transport. Access for service and delivery. Vehicle access for primary industries, agriculture and residential settlements.

SPEED 60 or 80 km/h, reduced at schools and settlements.

WIDTH Generally 20 m

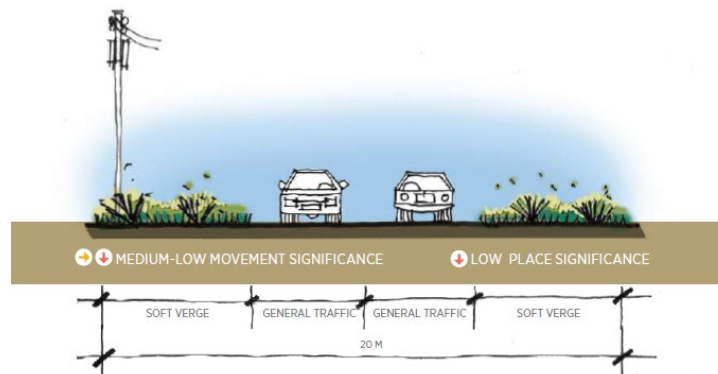

Rural Local Road	M1/PR
	<p>PLACE Serving rural land uses including schools and settlements, with direct access while protecting the natural environment. Provision for land drainage often required.</p> <p>MOVEMENT People on foot or cycle accessing nearby land use and public transport. Access for service and delivery. Vehicle access for primary industries, agriculture and residential settlements.</p> <p>SPEED 60 or 80 km/h, reduced at schools and settlements.</p>
<p>WIDTH Generally 20 m</p>	

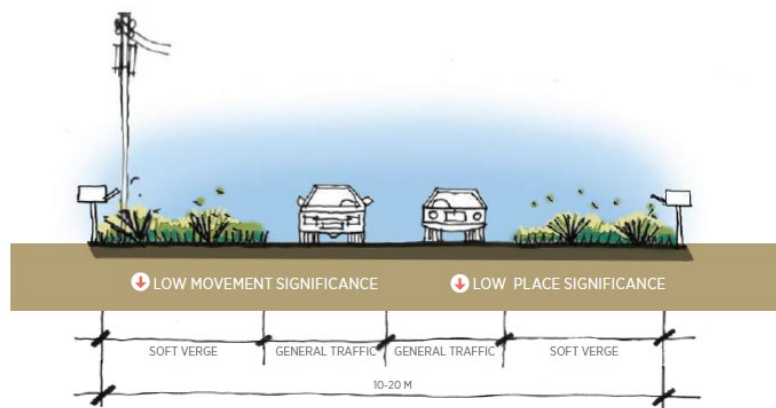

3.2.4 Road element design

Street types and approximate widths derived from Section 3.1.2 and Section 3.1.3 above must then be used in conjunction with the following sections of this Code to determine the widths of individual elements in the street or road. This will then set the width of the road reserve required for those elements:

Urban and rural roadway design	Traffic lanes, including bus and transit lanes	(Section 3.3)
Footpaths and the public realm	Footpaths, landscaping and street furniture	(Section 3.4)
Cycling infrastructure	Facilities on road (supplementing Section 3.3) or off-road (supplementing Section 3.4)	(Section 3.5)
Public transport	Bus infrastructure – including stop facilities for buses & passengers	(Section 3.6)
Traffic calming	Some measures may require additional width locally	(Section 3.7)
Parking design	Specific on-street parking spaces	(Section 3.8)
Pavement and surfacing	Only affects width of road foundation below ground	(Section 3.9)
Geotechnical and structural design	Including embankments, cuttings and retaining walls	(Section 3.10)
Road drainage and surface water control	Including treatment devices & roadside drains that may require extra width	(Section 3.11)
Street lighting	Only affects width where pole clearances are critical	(Section 3.12)

3.3 Urban and rural roadway design

The geometric design of the urban street and rural road networks is important to ensure that correct operation at the right road speed occurs in a safe and predictable manner.

It is critical when designing the roadway infrastructure to consider how maintenance of the road environment can be achieved in a safe and cost-effective manner.

The rules and requirements contained in this code will take precedence over any other standard unless agreed by Departure, however the following geometric standards and advice notes may be used to supplement this code:

Austrroads *Guide to Road Design*, 2010:

- Part 1 Introduction to Road Design (GRD1)
- Part 2 Design Considerations (GRD2)
- Part 3 Geometric Design (GRD3)
- Part 4B Roundabouts (GRD4B).

3.3.1 Design parameters

3.3.1.1 Design speed

Maximum safe speed

The design speed of a road is the maximum speed at which a vehicle can safely travel on that road under good conditions.

For rural roads or high-speed urban roads with intended speed limit >60 km/h, the 85th percentile speed shall be used with the design speed being 10 km/h higher for the posted speed checks.

Section 3 of the Austrroads 2010 *Guide to road design, Part 3: Geometric design* contains detailed information on the assessment of the 85th percentile speeds and how it can be derived for rural and urban environments.

3.3.1.2 Design vehicles

The NZ Transport Agency's *Road and traffic standards* (RTS) 18:2005 (New Zealand on-road tracking curves for heavy motor vehicles) is not to be used for urban or rural roads in the Auckland region.

- **Turning speed** for buses and check vehicles should generally be in the range of 5-25 km/h:
 - For roads with design speed greater than 50 km/h, turning speed may be increased where deceleration lane space cannot be provided and no conflict with people on foot or on bikes will occur. The design turning speed should correlate with the operating speed
 - Some manoeuvres will require a lower swept path speed than intersections. Manoeuvre speed down to 3 km/h may be used.

- **Swept path width:** The path for design shall be the body width of the vehicle, plus 0.5 m
- **Tracking profiles:** The design and check vehicle profiles can be downloaded from the TDM home page
- **Buses:** Bus tracking must use all standard Auckland Transport bus types
- **Freight, over dimensional and overweight routes:** All freight routes, require 19.45 m semi as design vehicle and 23 m truck & trailer as check vehicle.

Design and check vehicles for each road type

Design vehicles are the largest vehicles that frequently use particular roads. They are expected to be able to remain within their allotted traffic lane.

Check vehicles are larger vehicles that may be expected to use a road from time to time. They may not be able to remain within a traffic lane at all times.

The following road types/design vehicles must be used at all times, unless it can be demonstrated that a different design or check vehicle is appropriate in a specific case.

Table 2: Design vehicles

Vehicle	Description
50%ile car	<ul style="list-style-type: none"> • This is more manoeuvrable than the 6.3 m van. • It should be used as a Check vehicle for all intersections and conflicts to establish a maximum Safe Path speed. • This is required for Safe to Go and Safe Avoidance checks.
85%ile car	<ul style="list-style-type: none"> • This is the minimum vehicle size to be used for residential vehicle crossing design.
6.3 m van	<ul style="list-style-type: none"> • A car with trailer very closely matches the 6.3 m van (2 m wide) therefore it is easier to use a van for the design vehicle. • This is the basic vehicle that all roads should accommodate.
8.3 m truck	<ul style="list-style-type: none"> • More appropriate than RTS18 8 m rigid truck.
12.6 m bus	<ul style="list-style-type: none"> • Required bus for all urban bus routes.
13.5 m bus	<ul style="list-style-type: none"> • Rear-steer axle results in significant tail swing, which should be checked for all current and potential bus manoeuvres.
Other bus	<ul style="list-style-type: none"> • Refer to TDM home page for all bus types to be included in all routes (in or out of service, schools and repositioning) that may be used by buses.
17.9 m semi	<ul style="list-style-type: none"> • Largest vehicle for service deliveries to retail (e.g. supermarkets).
19.45 m semi	<ul style="list-style-type: none"> • General design vehicle for freight routes (HPMV).
23 m truck & trailer	<ul style="list-style-type: none"> • Check vehicle for freight routes (HPMV, car transporter).

Table 3: Design vehicles for street types

Mid-block				
Road Classification	Design vehicle	Tracking type	Check vehicle	Tracking type
Local (residential or retail)	6.3 m Van	A	10.3 m Truck	A, B
Local (Commercial or Light Industrial)	8.3 m Truck	A	17.9 m Semi	B
Local (Industrial estate with significant freight movement)	12.6 m Rigid	A	23 m Truck & Trailer	B
Local (Bus route)	12.6 m Bus	A	13.5 m Bus	B
Collector (Residential – no bus route)	8.3 m Truck	A	10.3 m Truck	B
Collector (Commercial)	12.6 m Rigid	A	19.45 m Semi	B
Collector (Bus route)	12.6 m Bus	A	13.5 m Bus	B
Arterial (first general lane)	19.45 m Semi	A	23 m Truck & Trailer	B
Arterial (additional lanes)	8.3 m Truck	A	23 m Truck & Trailer	B
Arterial (Bus or Transit lane)	12.6 m Bus	A	13.5 m Bus	B

Intersections				
Road Classification	Design vehicle	Tracking type	Check vehicle	Tracking type
Local ▶ Local (residential or retail)	6.3 m Van	A	10.3 m Truck	E
Local ▶ Local (residential – bus route)	6.3 m Van	A	13.5 m Bus	E
Local ▶ Local (Commercial/Industrial)	8.3 m Truck	A	17.9 m Semi	E
Local ▶ Arterial or Collector	As above	A	As above, depending on use	D
Collector ▶ Collector (Residential – no bus route)	8.3 m Truck	A	10.3 m Truck	D
Collector ▶ Collector (Commercial)	12.6 m Rigid	A	19.45 m Semi	D
Collector ▶ Collector (Residential – bus route)	12.6 m Bus	A	13.5 m Bus	D
Collector ▶ Arterial	As Table 2 for the Collector	A	As Table 2 for the Collector	D
Arterial ▶ Arterial	19.45 m Semi	C, F	23 m Truck & Trailer	B, C

Table 4: Tracking type

A	Remain within marked lane, or allow safe encounter with conflicting Design vehicle where no lane is marked
B	Do not cross a marked centerline or flush median to penetrate opposing traffic lane
C	May use adjacent lanes in same direction
D	Conditions B, C apply on major (or crossing) road, E on minor (or terminating) road
E	May use full road width to turn
F	For multiple turning lanes, Design vehicle and a 8.3 m truck must be able to turn together without penetrating opposing traffic lane

Principles for swept paths

Kerblines should follow swept path closely, with 0.5 m clearance from wheel track, to minimise risk of wheels damaging the kerb.

Swept path graphs for design vehicles

Please refer to Appendix A for the following graphs:

Graph 1	6.3 m van	Swept path no clearance
Graph 2	8.3 m truck	Swept path no clearance
Graph 3	10.3 m rubbish truck	Swept path no clearance
Graph 4	12.6 m bus	Swept path no clearance
Graph 5	12.6 m large rigid truck	Swept path no clearance
Graph 6	13.5 m bus	Swept path no clearance
Graph 7	17.9 m semi (RTS18)	Swept path no clearance
Graph 8	19.45 m semi (HPMV)	Swept path no clearance
Graph 9	23.0 m T&T	Swept path no clearance

3.3.1.3 Visibility for safety**Different types of sight distance**

Austrroads *Guide to road design* describe various sight distances that are normally considered. They are grouped below according to task type:

- Part 3: Geometric design (GRD3)
- Part 4A: Unsignalised and signalised intersections (GRD4A), and
- Part 4B: Roundabouts (GRD4B)

GRD3 also provides guidance on applying sight distances to specific circumstances:

- Sight distances on horizontal curves
- Sight distances on horizontal curves with roadside obstructions
- Headlight sight distance (This should be consulted when assessing safety on unlit roads)
- Horizontal curve perception sight distance.

Sight distance for rural roads

The formulas should generally be used as described in Austroads GRD3 and GRD4A to generate the appropriate sight distances for the road speed.

Observer position

The observer may be stationary or moving, and eye height will vary with user type. Parameters from Austroads GRD3, GRD4A and GRD4B should be used for eye height

Friction and vehicle

Standard friction rates of 0.35 for cars and 0.26 for trucks should be assumed.

Austroads GRD3 gives guidance for unsealed roads.

Hazard object check vehicle

A factor of 0.48 g should be used to assess the path speed of a 50%ile car approaching a conflict zone.

Initial speed

For straight, unobstructed roads, Initial speed can be taken as 10 km/h above posted speed limit. Initial speed is generally taken as the design speed for the road.

Deceleration rate

The deceleration or acceleration rate is obtained by multiplying $g(9.81 \text{ m/s}^2)$ by a coefficient d .

Deceleration rate for Safe Path design should be $d = 0.25$ (2.5 m/s^2).

Acceleration rate

When considering acceleration of a design car from stationary, or from an initial speed, for Safe Path or Safe to Go, use the table below.

Coefficient d should be modified by adding 0.005 for each % grade down or subtracting 0.005 for each % grade up (0.0025 when speed greater than 50 km/h).

Table 5: Acceleration rate

Initial speed		Acceleration rate		Coefficient d
(km/h)	(m/s)	(km/h/s)	(m/s ²)	
≤40	≤11.11	4.7	1.3	0.13
50	13.88	4.3	1.2	0.12
60	16.66	3.6	1.0	0.10
70	19.44	3.2	0.9	0.09
80	22.22	2.9	0.8	0.08
90	25.00	2.5	0.7	0.07
100	27.77	2.1	0.6	0.06
110	30.55	1.8	0.5	0.05

3.3.2 Geometric alignment

3.3.2.1 Horizontal alignment

Urban road alignment

For all urban roads with a design speed of 50 km/h or less, lane lines and kerb lines shall be determined or confirmed by the use of vehicle tracking.

Table 2 (Design vehicles) with Table 3 (Design vehicles for street types), defines controls on tracking to encourage safe encounters.

On roads that may continue to have a higher design speed than 50 km/h in future, the designer may introduce transition curves applicable to the higher design speed. Transition curves must be calculated as outlined in the Austroads *Guide to road design, Part 3: Geometric design*.

The minimum radius for curves between intersections must be calculated as outlined in the Austroads *Guide to road design, Part 3: Geometric design*. This requires calculation for design speed below 40 km/h.

Rural road alignment

Where the posted speed is 60 kph or greater, then the geometry should be designed in accordance with Austroads *Guide to road design, Part 3: Geometric design*

3.3.2.2 Vertical alignment

- **All rural roads:** For rural roads, the design of the vertical alignment must be as outlined in *Austrroads Guide to road design, Part 3: Geometric design*
- **Urban arterial roads > 50 kph:** The design of the vertical alignment must be as outlined in *Austrroads Guide to road design, Part 3: Geometric design*
- **All urban roads < 50 kph:** The design of the vertical alignment must be appropriate for the site location. Sag / Crest curves: Start with Sag K value of 9 and Crest K value of 10 and reduce if necessary
- **Other guides:** Where traffic calming measures are required, refer to Section 3.7: *Traffic calming*.

3.3.2.3 Longitudinal gradients

The minimum acceptable longitudinal gradient is to be based on acceptable road drainage criteria (see Section 3.11: *Drainage*). Gradients should not be steeper than 8% but may be increased above 8% where topographical constraints exist. In this situation, advice should be sought from Auckland Transport for Departure from Standard. Gradients exceeding a Departure from Standard should deviate as little as practically possible and may not exceed 12.5% for vesting as public road.

3.3.3 Camber, cross-fall and super-elevation

3.3.3.1 Cambers and cross-falls

- **Minimum transverse gradient:** Minimum transverse gradients of 3% towards the outer edge of the road should normally be used on all sealed roads. However, where existing features prevent this, the camber or cross-fall may vary between 2% and 4%. On unsealed roads, minimum transverse gradients of 4% towards the outer edge of the road should normally be used.
- **Maximum transverse gradient:** The maximum transverse gradients are 5% for sealed roads and 6% for unsealed roads respectively.
- **Transverse gradient in relation to longitudinal gradient:** Transverse gradient steeper than 3% (up to 5%) is preferred on steep roads to encourage drainage towards the road channel. Where longitudinal gradient is less than 1%, crossfall must not be less than 3%, to encourage sheet flow to road edge.
- **Intersections:** At intersections, the camber of the major road should take priority and the minor road should be designed so that it grades into the channel line of the major road.
- **Adverse cross-fall:** Adverse cross-fall (fall towards the outside of a bend) will not be permitted on roads with design speed greater than 50 km/h.

3.3.3.2 Super-elevation

Super-elevation must be applied as outlined in the *Austrroads Guide to road design Part 3: Geometric design, Section 7.7 Super-elevation*. The maximum super-elevation should be limited to 5% in areas where pedestrian movements are prevalent.

3.3.4 Standard road configuration

3.3.4.1 Clearance envelopes

- **Standard clearances:** Clearance envelopes are shown in Standard Engineering Details GD0001, GD0002 AND GD0003¹
- **Clearance from fixed structures:** Vertical and horizontal clearances are shown on GD0001
- **Clearance from vegetation:** Vertical and horizontal clearances are shown on GD0002
- **Over-dimension vehicle routes:** For over-dimension routes, the clearance envelopes must be in accordance with New Zealand Heavy Haulage Association (NZHHA) *Road design specifications for over-dimensional loads* or as agreed with Auckland Transport Road Corridor Access. See also Auckland Transport TDM SEC GD0003.

3.3.4.2 Lane widths

- **Vehicle lane:** Vehicle lane width is measured between the centre of line markings, and to the edge of road seal. A concrete drainage channel is not to be included in traffic lane width.
- **Influencing factors:** Lane widths are generally between 2.7 m and 4.2 m. Generally, wider than 3.4 m can lead to poor channelling of traffic, higher speed and reduced safety. A lane width greater than 4.2 m can lead to vehicles forming two lines of traffic and generally should be avoided.
- **Curve widening:** Curve widening additional to the lane widths given below may be required at bends. Minimum curve radius relative to design speed for each design and control vehicle is given in Graphs 1–9 (refer to Appendix A) and shall be used for all curves.
- **Application of curve widening:** Widening shall be determined for appropriate combinations of Design and Check vehicles as required in Table 2 and Table 3. Tracking width shall be determined from Graphs 1-9.

Table 6: Speed environment >50 km/h

Road	Land width	Notes
Arterial	3.5 m preferred 3.0 m minimum	<ul style="list-style-type: none"> • The minimum width cannot be used on a bus or heavy freight route.
Collector	3.3 m preferred 3.0 m minimum	<ul style="list-style-type: none"> • Collector roads should rarely have a speed environment > 50 km/h.
Local	3.1 m preferred 2.7 m minimum	<ul style="list-style-type: none"> • Local road speed environment > 50 km/h will be rural roads only.

For speed environment > 50 km/h, shoulder must be provided. Note: includes urban and rural roads.

¹ <https://at.govt.nz/media/1982216/geometric-design.pdf>

Table 7: Speed environment 50 km/h or less

Road	Land width	Notes
Arterial	3.2 m preferred 3.0 m minimum	<ul style="list-style-type: none"> Preferred width increased to 3.5 m on a frequent transit network (FTN) bus route or designated freight route.
Collector	3.2 m preferred 3.0 m minimum	<ul style="list-style-type: none"> The minimum width cannot be used on a bus or heavy freight route.
Local	3.0 m preferred 2.7 m minimum	<ul style="list-style-type: none"> Preferred width increased to 3.5 m for freight access to industrial land uses. The minimum width cannot be used on a bus or heavy freight route. Parking restrictions may be required if the minimum width is used.

Note: Designers are required to use the preferred width. The minimum width is a guide for Departure where existing site constraints prevent achieving preferred width.

Includes urban and rural roads.

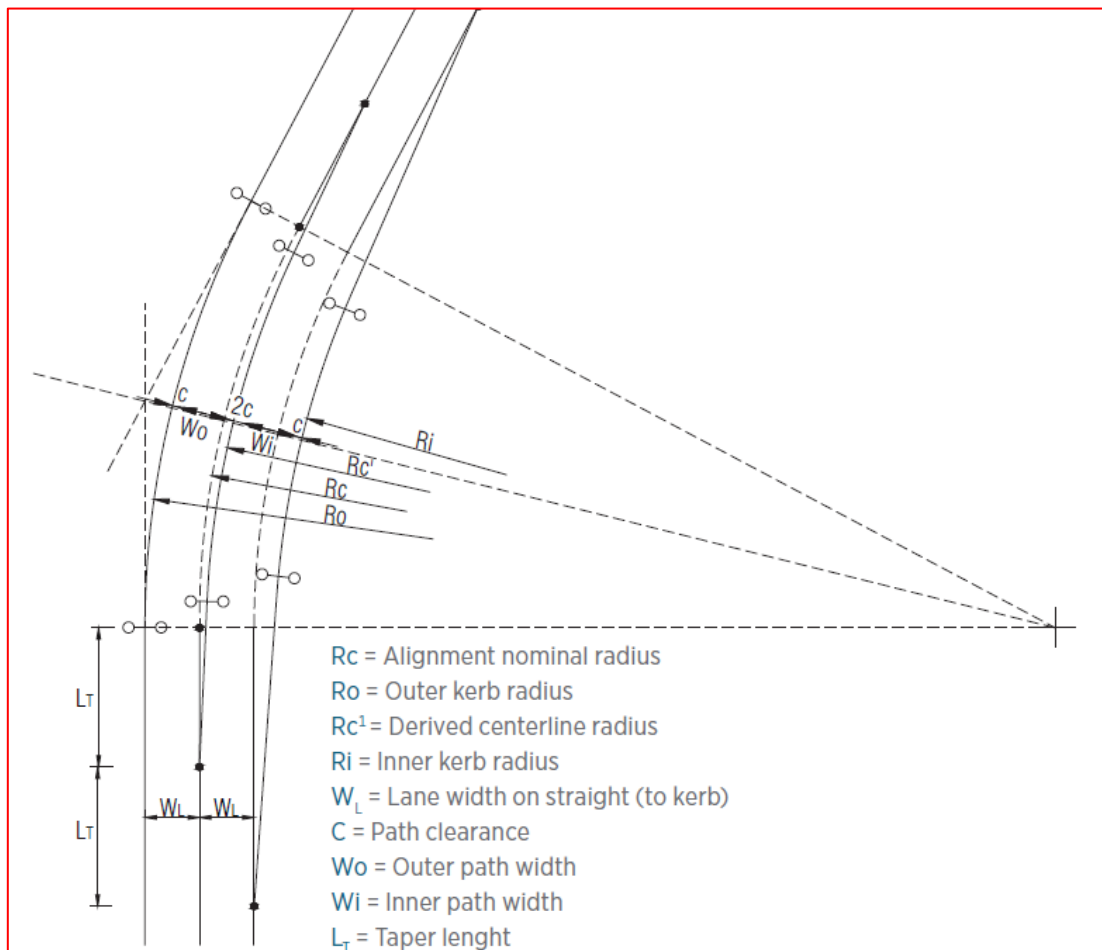

Figure 1: Application of curve widening

- **Wide kerbside lanes:** Wide kerbside lanes may be required for functions that change through the day. Wide kerbside lanes should be between 4.2 and 5.0 m wide.
- **Clearways:** Clearways can be reasonably safe for confident people on bikes in the mid-block, but they introduce problems at intersections, as cycle facilities crossing the side streets cannot be marked. (People on bikes travel in a kerbside position during clearway operating times, but outside of parked vehicles at other times.) A more desirable solution is to provide a protected cycleway where there is a clearway.

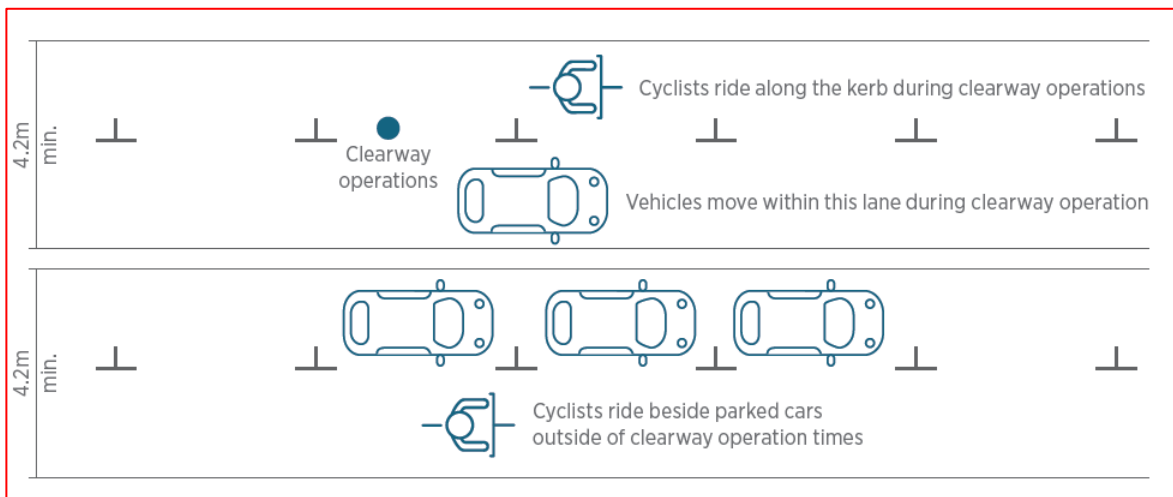

Figure 2: Clearway use by people on bikes with parking during off-peak periods

3.3.4.3 Parking

Parking standards applied to on-street carparks or Auckland Transport owned carparks are described in the Section 3.8: *Parking*.

3.3.4.4 Flush medians

Flush medians should be provided only where:

- Separation of opposing road users is desirable for safety
- Right turning traffic is interfering with through traffic on the arterial roads causing accidents or problems with delays
- Where the carriageway is excessively wide and there are no other practical solutions.

The width of a flush median depends on the environment, as shown in the table below.

Table 8: Flush median widths

Road	Flush median width
Arterial	2.5 m where turning is allowed 0.5 m for buffer separation
Collector	Flush medians are not to be used except locally for safety
Local roads	Flush medians are not to be used at all, visual narrowings should be provided.

3.3.4.5 Road shoulders

The road shoulder is an extension of the carriageway by a minimum of 0.5 m to provide structural support to the sealed road. The table below outlines the acceptable widths in different situations.

Table 9: Acceptable road shoulder widths

Shoulder width	Situation
0.5 – 1.0 m	<ul style="list-style-type: none"> Only to be used on low-volume rural roads when doing pavement overlays/ rehabilitations.
1.0 m	<ul style="list-style-type: none"> The minimum width next to a safety barrier and the recommended minimum for most situations.
1.5 m	<ul style="list-style-type: none"> The preferred width for a sealed shoulder.
2.0 – 2.5 m	<ul style="list-style-type: none"> For use on higher speed and/or higher volume roads, particularly where vehicles have to be able to stop outside of the running lanes.

3.3.4.6 Road safety barrier systems

Where a road safety barrier is required in the urban environment, careful consideration must be given to the nature and land use context of the corridor as to whether the barrier and the supporting terminals should be installed.

In the rural environment, provision of clear zone should be considered first, and safety barrier limited to hazards that cannot be protected by clear zone or other safety management.

If the operational speeds along the road cannot be reduced sufficiently by local speed management controls then the provision of barriers may be necessary. The provision of barriers needs to be considered against the adjacent land uses, driveway positions, accessibility arrangements and urban amenity.

The design of road safety barrier systems must be compliant with 'crash tested design' or approved under NZTA Standards *Section 3: Approval of road safety barrier systems for road safety*.

Steel guardrail

Steel guardrails are to comply with the NZ Transport Agency M23:2009².

Construction

All guardrail installed is to be 2.7 mm thick with posts at 1905 mm spacings. 'W'-section guardrails, backing pieces and splice bolts shall comply with Specification NZ Transport Agency M/17P for bridge guard rails.

Rectangular hollow sections for the posts and cable anchor fittings may be hot rolled complying with AS/NZS 3679.1³ or cold rolled complying with AS1163⁴.

² Specification for road safety barrier systems

³ Structural steel - Part 1: Hot-rolled bars and sections

⁴ Cold-formed structural steel hollow sections

Commercial grade nuts and bolts are to be used in the assembly of the handrail/guardrail components and shall comply with AS 1111.1⁵ and AS 1112.3⁶. The bolts shall be Property Class 4.6 and the nuts shall be Property Class 5.0. Special M20 bolts for cast in brackets and U bolts shall similarly be of Property Class 4.6.

Timber posts, boards, bollards and block out piece shall be Pinus Radiata No1 framing grade in accordance with NZS 3631⁷, treated to NZS 3640⁸ Hazard Class H4 after cutting and drilling. Timber shall not be used unless its moisture content has been lowered to below 20%, by kiln or natural drying.

Auckland Transport requires consultants and contractors carrying out design and/or supervision work involving road safety barriers to have attained the NZTA “Barrier Design & Certification Qualification” (BDCQ) which is applicable for design and have someone available within their organisation with this qualification to sign-off road safety barrier designs and/or installations.

End terminals/ end treatments

Leading end terminals and trailing end anchors are to comply with NZTA M23.

The Appendix to NZTA M23 lists along with NRCHP350⁹, the current approved generic and proprietary terminal alternatives and the Contractor shall seek approval from the Auckland Transport representative for the use of any proprietary system.

Concrete barriers

Where individual sections of concrete barriers are to be installed or replaced, the barrier shall be constructed so as to match the adjoining barrier profile. If a length of barrier is to be replaced, NZHHA the barrier length shall comply with the requirements of NZTA M23.

Other requirements

Road safety barrier systems must be designed and installed in accordance with the following:

- AS/NZS 3845:1999: *Road safety barrier systems*
- NZTA M/23: *Specifications & guidelines for road safety hardware & devices*
- NZTA M/17P: *Specifications for bridge guard rails*
- NZTA RTS5: *Guidelines for rural road marking & delineation*
- NZS 3109:1997: *Concrete construction*
- NZS 3114:1987: *Specification for concrete surface finishes*
- AS/NZS 1554.5:1995 A1: *Welding of steel structures subject to high levels of fatigue loading*
- NZTA's *Bridge manual SP/M/022*
- NZTA *Geometric design manual, Section 7- Roadside features*
- NCHRP 350: *Recommended procedures for the safety performance evaluation of highway features*
- NZTA, RTS 11: *Urban roadside barriers and alternative treatments*
- Austroads: *Guide to road safety*
- AASHTO – *Roadside design guide*, 4th edition 2011

⁵ ISO metric hexagon bolts and screws

⁶ ISO metric hexagon nuts

⁷ New Zealand timber grading rules

⁸ Chemical preservation of round and sawn timber

⁹ National Cooperative Highway Research Program

3.3.4.7 Clear zones

State highway geometric design manual

Clear zones are measured from the outside edge of the lane and include any berms, batters and footpaths adjacent to it. The required width depends on the site, as set out in the NZTA State Highway *Geometric design manual, Part 6, Section 6.5, The clear zone*.

Rural roads

All rural roads must have a clear zone as outlined in the NZTA State Highway *Geometric design manual*.

Urban roads

While most urban roads do not require a clear zone, in some circumstances where there are higher speeds or a history of crashes and vehicles leaving the carriageway, a clear zone may be considered as part of any improvements to the road. However, such a zone is a last resort if there are no practical alternatives.

3.3.4.8 Cul-de-sac geometry

The maximum gradient in any direction within the turning area of a cul-de-sac should not exceed 5%. Acceptable dimensions for standard turning heads are shown in Auckland Transport's *Standard Engineering Details Guidance Design* series.

3.3.5 Kerb and channel

Standard Engineering Details series show standard details of kerbs and channels.

3.3.5.1 Kerb types

Select the type according to the table below:

Table 10: Kerb type according to situation

Kerb type	Situation	
1	Standard kerb & channel	<ul style="list-style-type: none"> General use to separate roadway from roadside, where surface water is to be conveyed to a collection point. May not be suitable for design speed > 60 km/h.
1A	Reinforced haunching	<ul style="list-style-type: none"> Any location where the back of the kerb is not supported its full height by concrete paving or planted berm.
1C	On side	<ul style="list-style-type: none"> Only for vehicle crossings that must be trafficked soon after construction.
1S, 2S	Shear key	<ul style="list-style-type: none"> Where a kerbline may be subject to vehicle strike, unless fully backed by rigid paving.
2A	Battered kerb & channel	<ul style="list-style-type: none"> As Type 1, where it is likely that vehicle tyres may rub.

Kerb type	Situation	
2B	Mountable kerb & channel	<ul style="list-style-type: none"> As Type 1, but where vehicles may occasionally cross the kerblines.
3	Extruded standard kerb & channel	<ul style="list-style-type: none"> General use to separate roadway from roadside, where surface water is to be conveyed to a collection point. May not be suitable for design speed > 60 km/h.
4	Vehicle crossing	<ul style="list-style-type: none"> Cut-down of Type 3 where installed continuously where a vehicle crossing is to be constructed.
6	Extruded mountable kerb & channel	<ul style="list-style-type: none"> As Type 3, but where vehicles may occasionally cross the kerblines.
7	Extruded standard kerb and nib	<ul style="list-style-type: none"> As Type 3, but where a channel is not required for surface water conveyance.
7	Extruded standard kerb vehicle crossing	<ul style="list-style-type: none"> Cut-down of Type 3 where installed continuously where a vehicle crossing is to be constructed.
8	Edging	<ul style="list-style-type: none"> Edging between footpath and planted berm.
9	Edging nib kerb	<ul style="list-style-type: none"> Transition beam at end of Type 12 kerb on bridge.
10	Standard kerb and nib	<ul style="list-style-type: none"> As Type 1, but where a channel is not required for surface water conveyance.
11	Traversable kerb	<ul style="list-style-type: none"> Edge of paved areas frequently over-run by large vehicles (such as roundabout islands).
12	Safety kerb	<ul style="list-style-type: none"> Across bridge decks or atop retaining walls, where a vehicle containment kerb is required.
13	'Kassel' bus stop kerb	<ul style="list-style-type: none"> Kassel Kerbs® should be used for all bus stops, both new and when being renewed.
14	Cycle path angled kerb	<ul style="list-style-type: none"> At edge of cycle path.
15	Cycle path mountable kerb	<ul style="list-style-type: none"> At edge of cycle path where cyclists frequently cross.
16	Flat edge beam	<ul style="list-style-type: none"> Edge containment for pavement construction where road layout does not require vehicle containment or separation of roadway from foot or cycle path. Includes sheet-flow drainage
17	Mountable kerb for over-dimension routes	<ul style="list-style-type: none"> Specific mountable kerb for use on traffic islands, pedestrian refuges and central islands on roundabouts on official heavy haulage over-dimension routes.

3.3.5.2 Channel types

Channels are to be used only where needed for road drainage. Select the type according to the table below:

Table 11: Channel types

Channel type	Situation	
1	Standard kerb & channel	<ul style="list-style-type: none"> General use to separate roadway from roadside, where surface water is to be conveyed to a collection point.
3	Extruded standard kerb & channel	<ul style="list-style-type: none"> General use to separate roadway from roadside, where surface water is to be conveyed to a collection point.
5	Pram crossing	<ul style="list-style-type: none"> Any location where footpath or cycle path is to cross a roadway
17	V-dish	<ul style="list-style-type: none"> Where Type 1 or 3 kerb is interrupted by parking bays.
18	Deep V-dish	<ul style="list-style-type: none"> Between paved areas that fall towards the channel, e.g. large car parks.
19	Round dish	<ul style="list-style-type: none"> In shared or pedestrian paved areas.

3.3.5.3 Pram and cycle crossings

At pram and cycle crossings, the kerb must form a V-shaped channel with raked sections at either side. A flush transition with no lip must be provided between the footpath and the channel. The length of any transition kerb will be affected by acceptable grade of berm or footpath behind the kerb.

3.3.5.4 Transitions

Where different kerb or channel types meet, transition sections are required, generally 600 – 1200 mm long.

3.3.5.5 Rural roads

Kerbs and channels will generally only be required in rural areas:

- Where grades are steeper than 8%
- In cuttings to minimise earthworks
- In areas of potential instability
- To direct water to suitable discharge points
- At signed or marked bus stops to provide a platform for passengers to board or alight from a bus.

3.3.6 Vehicle crossings

3.3.6.1 Crossing types

All vehicle crossings must be designed in accordance with the relevant vehicle crossing drawing contained in Auckland Transport's Standard Engineering Details.

3.3.6.2 Widths

A driveway crossing must be no wider at the boundary than it needs to be, e.g.:

- A two-way driveway in a residential zone that is 5.5 m wide will require the crossing to be 5.5 m at the boundary or may be narrowed to 2.75 m if there are passing places with clear sight lines
- One way access in a centres/mixed use zone may only need to be 3 m wide
- Refer to relevant Auckland Transport TDM SED series VX0000.

3.3.6.3 Design vehicle

The standard design vehicle for residential vehicle crossings is the 85thile car.

3.3.6.4 Path through-route

The levels and width of the pedestrian through route should not be altered, except that the width may be reduced to not less than 0.9 m where necessary to provide the vehicle ramp down to the channel line.

Path crossfall should be 1-2% where possible, or within $\pm 3\%$ where constrained.

For steep driveways requiring a change in the level of the footpath through the crossing, footpath ramps either side of the crossing should not exceed a grade of 8%. If this is not possible, the grade should not exceed 12% and the level difference at this grade should not exceed 75 mm. Check surface water flow depth to avoid flood nuisance.

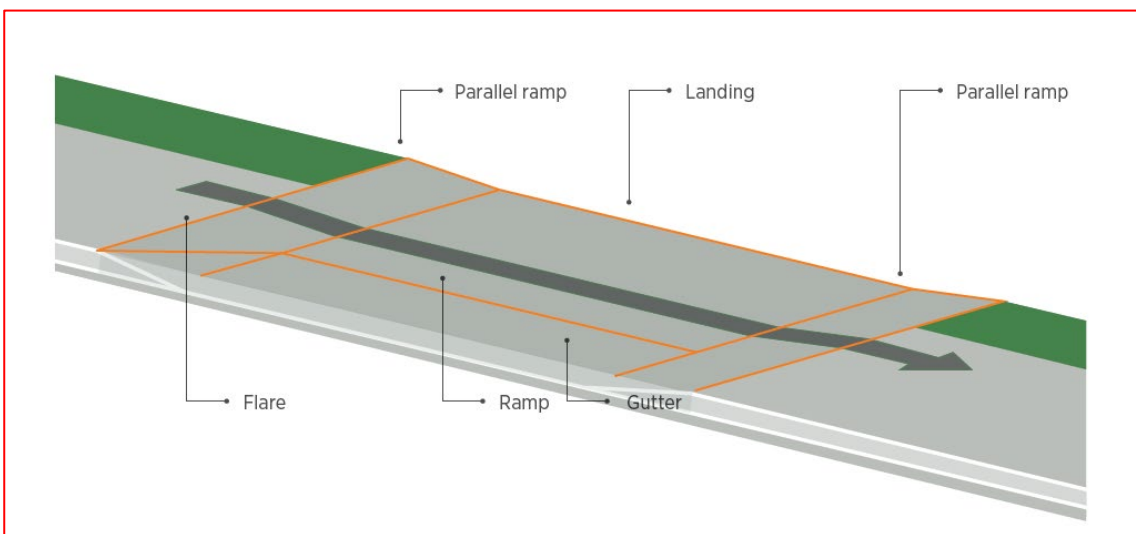

Figure 3: Dropped footpath for steep driveway

3.3.6.5 Grade

Consideration shall also be given to the grade of the driveway to help prevent vehicles scraping and stormwater entering the driveway.

If existing road crossfall exceeds 3%, the grade of the 900 mm ramp from the channel shall be reduced from 15% so that the grade change at the channel does not exceed 18%.

3.3.7 Intersection design & types

3.3.7.1 General principles

Good intersection design is based on sound geometric design and user criteria where safety is a primary consideration. Intersection principles are:

- As compact as possible
- Part of a multi-modal network
- Integrate time and space
- Intersections are shared spaces
- Design for context.

See Auckland Transport's *Urban street and road design guide* for more detail on these.

Corner kerblines

Kerblines should follow swept path, with 0.5 m clearance from wheel track. See Auckland Transport's *Urban street and Road design guide: Chapter 6 Intersection geometry - Effective turning radius* for an example of this.

Kerb crossings

Kerb crossings must be provided at each kerb-line at all intersections as outlined in the Engineering Design Code, *Footpaths and the public realm* and NZTA RTS 14¹⁰.

Raised table crossings

See Section 3.7: *Traffic calming*, for further details.

Parking near intersections

Line markings for 'No stopping at any time' must be provided over sufficient length to ensure parking does not occur within the swept paths of design or check vehicles.

It is preferable that corner kerblines should define traffic lanes, and that parking should have indented bays with kerbline return to the traffic lane.

¹⁰ *Guidelines for facilities for blind and vision-impaired pedestrians, 2008*

Where existing streets have continuous parking shoulders without returns near intersections and only where the existing kerbline cannot be altered, the swept path of design and check vehicles must be kept clear by 'No stopping at any time' markings and the corner kerbline must be designed to match the swept path. This will generally be a small radius curve.

3.3.7.2 Roundabouts

The rules and requirements contained in this code will take precedence over any other standard unless agreed by Departure, however the following geometric standards and advice notes may be used to supplement this code:

- *Austrroads Guide to road design Part 4B: Roundabouts*
- *NZTA Guidelines for marking multi-lane roundabouts*
- *NZTA Manual of traffic signs and markings.*

When designing urban roundabouts, extra care must be taken to ensure vehicle speeds are at or below 25 km/h.

3.3.7.3 Signal controlled intersections and crossings

Geometry

Use Section 3.3.1.2 Table 2, Table 3 and Table 4 to determine vehicle path requirements. Geometry should be designed as 10.1 but with additional considerations for signal phasing.

Design guide

Traffic signal-controlled intersections must be designed as outlined in:

- *Austrroads guide to road design Part 4A: Unsignalised and signalised intersections*
- *NZTA Traffic control devices manual*
- *National traffic signal specification* dated November 2012; Revision 3.

Auckland Transport specification variations

The National Traffic Signals Specification (NTSS) shall be varied as follows:

- NTSS R3 2.3.1: All new traffic signal controllers must be RMS specification TSC4 compliant
- NTSS R3 2.7: All traffic signal poles must be painted, not powder coated
- NTSS R3 2.7: Finial caps of metal are not acceptable
- NTSS R3 2.7: Finial caps must be fastened so that they cannot be removed if fastening bolts are loose.

Auckland Transport design guidelines

In addition to the above key reference documents, Auckland Transport's specific requirements are currently based on the *Traffic management unit traffic signal design guidelines* dated August 2010 V3.0 with the following variations:

- 3.2: All overhead lanterns must be 300 mm in diameter
- 3.2: Lantern bodies can be of aluminium or polycarbonate construction.

Additional Auckland Transport design requirements

All new traffic signals are to be provided with a communications link to SCATS:

- All new traffic signal-controlled intersections will require a CCTV camera and associated equipment to connect to the Auckland Traffic Operations Centre
- All new traffic signal-controlled intersections will require an ADSL/VDSL connection to the Auckland Traffic Operations Centre
- New signals shall be designed to operate at a cycle time of no more than 100s.

3.3.7.4 Grade separation

Grade separated intersections must be designed as outlined in Austroads *Guide to Road Design Part 4C: Interchanges*.

References/guidelines

- Austroads *Guide to road design*, in particular the following parts:
 - Part 3: Geometric design
 - Part 4 Intersections and crossings – General
 - Part 4A: Unsignalised and signalised intersections
 - Part 4B: Roundabouts
- Austroads *Guide to traffic management Part 6: Intersections, interchanges and crossings*
- NZTA *Manual of traffic signs and markings* (MOTSAM)
- NZTA *Traffic control devices manual* (TCD manual)
- NZTA *Road and traffic standards series* parts:
 - RTS 1 Control at crossroads
 - RTS 14 Guidelines for facilities for blind and vision-impaired pedestrians
 - RTS 18 New Zealand on-road tracking curves for heavy vehicles
- TMU *Traffic signal design guidelines* dated August 2010 Version 3.0 (PDF 1MB) or later revision
- *National traffic signal specification* dated 1 September 2005; Revision 2 (PDF 665KB), which is available via the embedded hyperlink
- Transfund *Road safety audit procedures for projects*.

3.4 Footpaths and the public realm

This section provides design standards for pedestrian and amenity design that can be incorporated into roads and streets to achieve the desired outcomes.

3.4.1 Road and street zones

3.4.1.1 Urban street zones

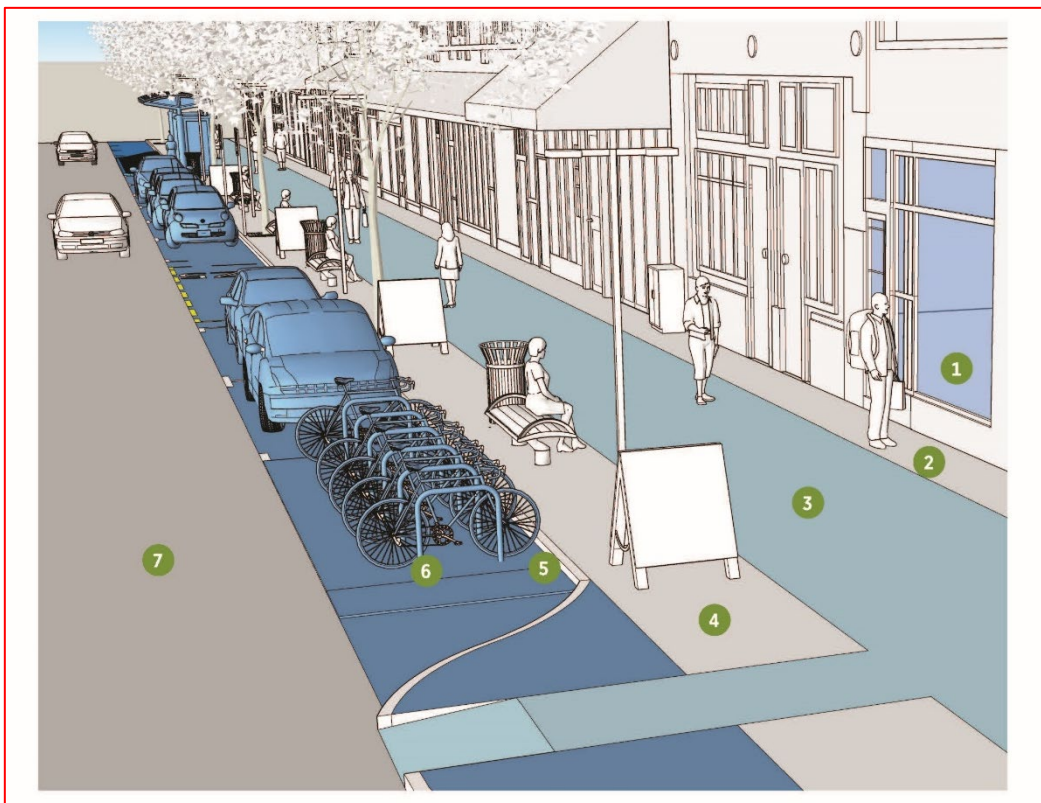

Figure 4: Urban street zones

- 1) **Adjacent lands:** The adjacent lands often contain active land uses, including places to eat and drink and ground-floor retail.
- 2) **Frontage:** The frontage zone is the space next to the building edge in centres.
- 3) **Through route:** The pedestrian clear path provides a movement zone for pedestrians that is clear of any obstacles.
- 4) **Street furniture:** This zone is the designated area for a variety of street furniture. The kerb divides carriageway from the roadside area.
- 5) **Kerb:** The kerb divides carriageway from the roadside area.
- 6) **Ancillary:** The ancillary zone sits between the furnishing zone and the carriageway
- 7) **Carriageway:** The carriageway provides space for vehicles to travel through the street.

3.4.1.2 Suburban street zones

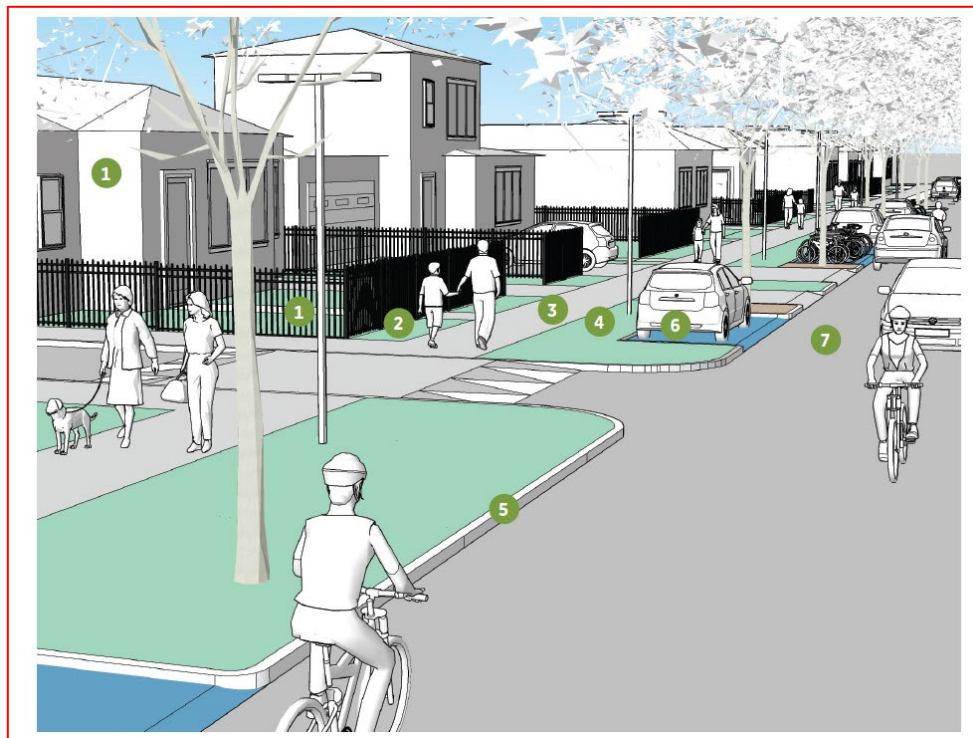

Figure 5: Suburban and rural street zones

Difference from urban street zones

The same zones are present as in urban streets, but their character and use differ.

- 1) **Adjacent lands - Land use:** The adjacent lands contain predominantly detached, single household dwellings.
- 2) **Adjacent lands - Land use:** Building setbacks form the front yards of residential properties.
- 3) **Frontage:** The frontage zone is the space between the property boundary and the footpath.
- 4) **Through route:** The pedestrian through route provides a path for pedestrian movement that is clear of obstacles.
- 5) **Berm (street furniture):** The berm is the designated area for soft landscaping.
- 6) **Kerb:** The kerb divides carriageway from the roadside area.
- 7) **Ancillary:** The ancillary zone is located in-between the berm and the travelled way.
- 8) **Carriageway:** The carriageway or travelled way provides space for travelling along the street for motor vehicles and people on bicycles.

3.4.1.3 Rural street zones

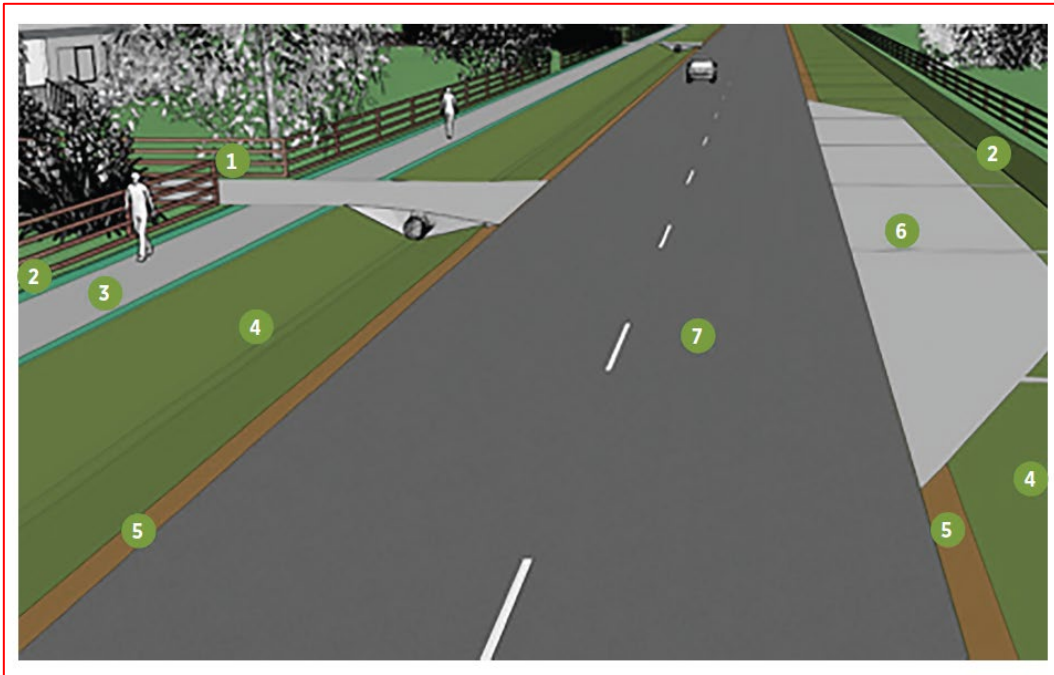

Figure 6: Rural street zones

Difference from urban street zones

The same zones are present as in urban streets, but their character and use differ.

- 1) **Adjacent lands:** These may be bush, agricultural land, coast or riverside.
- 2) **Frontage and rural land drainage zone:** This is the area that path users do not normally enter when passing.
- 3) **Through route:** This is the width that must be kept clear of obstructions to allow path users to pass.
- 4) **Frontage and rural land drainage zone:** This provides a location for safety barriers, signal poles, lighting columns, and any rural signs.
- 5) **Road edge:** Replaces what would be the kerb in urban settings.
- 6) **Ancillary:** The ancillary zone sits in-between the street furniture zone and the carriageway.
- 7) **Carriageway:** In addition to the traffic lanes, a partially-sealed shoulder should generally be included.

3.4.2 Footpaths and pedestrian facilities

Footpaths are those parts of a road or street intended for pedestrian use.

This Code takes precedence over any other standard unless agreed by a Departure from Standard application, however the following standards can be used to support the outcomes sought in this Code:

- NZTA *Pedestrian network guidance: 2021* (online publication) superseding NZTA *Pedestrian planning and design guide: 2009*
- RTS 14: *Guidelines for facilities for blind and vision-impaired pedestrians*
- Auckland Transport: *Guidelines for the selection of pedestrian facilities*
- Austroads: *Guide to road design – Part 4; Intersections and crossings*
- Austroads: *Guide to road design – Part 6A; Pedestrian and cyclist paths*
- AS/NZS 4586:2004: *Slip resistance classification of new pedestrian surface materials*
- AS/NZS 3661.1:1993 & AS/NZS 3661.2:1994: *Slip resistance of pedestrian surfaces*
- In all cases, later editions may supersede the ones cited.

3.4.2.1 Urban footpaths

Minimum zone widths

Table 12 shows the minimum footpath zone widths.

Table 12: Minimum footpath zone dimensions

Location	Maximum pedestrian flow	Zone				Total
		Kerb	Street furniture/ front berm	Through route	Frontage/ back berm	
Main street, mixed use & centres	80 p/min	0.15 m	2.5 m	2.4 m +	1 m (paved)	6.05 m+
Alongside parks, schools and other major pedestrian generators						
Outside and around public transport hubs						
Out-of-centre arterial	60 p/min	0.15 m	2.2 m	1.8 m	1 m	5.15 m+
Neighbourhood collector						
Local roads in residential areas	50 p/min	0.15 m	2.2 m	1.8 m	1 m	5.15 m

3.4.2.2 Rural footpaths

Minimum zone widths

Table 13 shows the minimum footpath zone dimensions based on the NZ Transport Agency's *Pedestrian planning and design guide*.

Table 13: Minimum rural footpath zone dimensions

Location	Maximum pedestrian flow	Zone				Total
		Kerb	Street furniture	Through route	Frontage	
Alongside parks, schools and other major pedestrian generators	80 p/min	0.15 m	1.2 m	2.4 m +	1.0 m	4.75 m
High speed roads (> 60 km/h)	60 p/min	0.15 m	1.2 m	1.8 m	1 m	4.15 m+
Low speed roads (<60 km/h)	50 p/min	0.15 m	0.9 m	1.8 m	1 m	3.85 m

3.4.2.3 Pedestrian access ways

Safe pedestrian access ways are core elements of a well-designed neighbourhood.

The recommended width is 8 m where pedestrian access ways connect one minor road to another. All pedestrian access ways should have a straight horizontal alignment and a vertical gradient as described in Table 14. The access way should be visible from end to end from an eye height of 1.5 m.

Where retaining walls are necessary between access way and higher adjoining property, these should preferably be stepped not more than 1 m high each rise, with a landscape strip of at least 0.5 m on each step.

3.4.2.4 Footpath gradients

Rest areas

An area at least 1.2 m long with longitudinal grade not more than 2% must be provided at the top and bottom of each length of footpath with gradient greater than 3%.

Prams & wheelchairs

The recommended gradient for wheelchair or pram ramps/kerb crossings is 5%.

Crossfall gradient

Crossfalls must be between 1% and 3%, with 2% preferred.

Footpath edges

Footpath edges should be level with adjoining surfaces to avoid trip hazards. Where plinths or steps are next to a footpath, they should be at least 150 mm high. Where there is a drop such as at the top of a retaining wall or edge of a rain garden, the edge should be protected. Up to 1 m, this may be a raised kerb at least 75 mm high, or a vegetated or contrasting hard surface 0.6 m wide outside the through route. A drop of more than 1 m must be protected by a method in accordance with the Building Code.

Table 14: Footpath gradients

Gradient maximum length	
3% or less	<ul style="list-style-type: none"> Continuous grade. No limit
3% - 5%	<ul style="list-style-type: none"> 120 m
5% - 8%	<ul style="list-style-type: none"> 45 m
Stairs	<ul style="list-style-type: none"> Handrail must be provided in compliance with NZS 4121¹¹ Clause 3.7.3.2.
8% - 10%	<ul style="list-style-type: none"> 9 m by Departure from Standard only
10% - 12.5%	<ul style="list-style-type: none"> 3 m by Departure from Standard only

3.4.2.5 Ramps and steps

Where a significant level difference exists along a route, the gradient required for an accessible route may require a ramp designed according to NZS 4121: *Design for Access and Mobility: Buildings and Associated Facilities*.

- Stairs are to comply with Compliance Document for New Zealand Building Code: Clause D1 – Access Routes (Preferred design as AS1)
- Treads are to be minimum of 310 mm. This may be combined with a tread projection not more than 25 mm
- Risers should be between 100 mm and 180 mm, with 120-150 mm Preferred
- Pitch should be between 32° (1V:1.6H) and 23° (1V:2.35H), with 23°. Preferred where cycle wheeling ramps may be used
- Height of flight not to exceed 2.5 m between landings. Minimum of three steps each flight, except single, low steps may be introduced where footpath grade would exceed 12.5%
- Preferred minimum width 1.2 m between handrails. Add extra width where frequent two-way movement is expected. Where width exceeds 2.4 m, additional handrails should be provided with one side not less than 1.2 m wide
- Features including nosings and TGS1 at top, bottom and landings must be provided in accord with RTS1410¹⁰

¹¹ *Design for access and mobility: buildings and associated facilities, 2001*

- Landings must be provided at the top and bottom and between each flight of steps. Landings shall be at least the width of the steps and 1.5 m long, or 1.8 m long where wheeling ramps are provided.

3.4.2.6 Footpath surfaces and construction

100 mm GAP granular basecourse bedding must be placed and compacted. Under footpaths and pram crossings, compaction must achieve a minimum Clegg Impact Value of 12 for concrete crossings, and 27 for asphalt crossings.

Pedestrian surfaces

All new materials proposed for pedestrian surfaces must comply with both the NZ Building Code and AS/NZS 4586¹². The minimum acceptable coefficient of friction (wet) to maintain slip resistance for Auckland Transport pedestrian assets is 0.40. This is consistent with the existing acceptable coefficient of friction as determined by AS/NZS 3661.1:1993¹³ of 0.40.

Table 15 below lists surface materials which generally have an acceptable coefficient of (wet) friction that meets the existing standards

Table 15: Auckland Transport – Acceptable pedestrian surface materials

Pedestrian surface	Level surface ¹		Sloping surface ² or stairs ³		Typical values for coefficient of friction (wet)
	Acceptable dry slip resistance	Acceptable wet slip resistance	Acceptable dry slip resistance	Acceptable wet slip resistance	CoF
Timber					
Uncoated profiled ⁴	Yes	Yes	Yes	Test	0.35 – 0.60
Coated and sand/grit impregnated ⁵	Yes	Yes	Yes	Yes	0.55 – 0.90
Portland cement concrete					
Broomed (class 5 or 6) or wood float finish	Yes	Yes	Yes	Yes	0.65 – 0.85
Coated and sand/grit impregnated ⁵	Yes	Yes	Yes	Yes	0.55 – 0.90
Exposed aggregate finish					
- Rounded aggregate	Yes	Test	Yes	Test	0.40 - 0.70
- Crushed aggregate	Yes	Yes	Yes	Yes	0.60 – 0.90

¹² Slip resistance classification of new pedestrian surface materials, 2004

¹³ Slip resistance of pedestrian surfaces, 1993

Pedestrian surface	Level surface ¹		Sloping surface ² or stairs ³		Typical values for coefficient of friction (wet)
	Acceptable dry slip resistance	Acceptable wet slip resistance	Acceptable dry slip resistance	Acceptable wet slip resistance	CoF
Porous concrete					
	Yes	Yes	Yes	Yes	0.65 – 0.68
Asphaltic concrete					
	Yes	Yes	Yes	Yes	0.60 – 1.00
Marble & granite					
Flamed finish	Yes	Yes	Yes	Yes	0.50 – 0.80
Split slate					
	Yes	Test	Yes	Test	0.40 – 0.55
Sandstone					
	Yes	Yes	Yes	Test	0.55 – 0.65
Ceramic tiles					
Unglazed – grit finish	Yes	Test ¹⁰	Yes	Test ¹⁰	0.35 – 0.65
Glazed– grit finish	Yes	Test ¹⁰	Yes	Test ¹⁰	0.45 – 0.60
Clay pavers					
Wire cut	Yes	Yes	Yes	Test	0.50 – 0.70
Concrete pavers					
Dry press concrete	Yes	Yes	Yes	Test	0.45 – 0.70
Interlocking concrete block paving ¹¹	Yes	Yes	Yes	Test	0.45 – 0.70
Moulded surface (e.g. simulated slate or concrete cobbles)	Yes	Test	Yes	Test	0.35 – 0.75
Permeable pavers					
	Yes	Yes	Yes	Yes	0.45- 0.70
Safety/ visual impaired					
Anti-slip tapes ¹⁴	Yes	Yes	Yes	Test	0.40 – 0.85
Type B tactile studs					
	Yes	Yes	Yes	Yes	0.84 – 0.87

Pedestrian surface	Level surface ¹		Sloping surface ² or stairs ³		Typical values for coefficient of friction (wet)
	Acceptable dry slip resistance	Acceptable wet slip resistance	Acceptable dry slip resistance	Acceptable wet slip resistance	CoF
Type B tactile pavers					
Unsealed	Yes	Yes	Yes	Test	0.68 – 0.80
Sealed	Yes	Yes	Yes	Yes	0.80 – 0.88
Type C directional ground surface pavers					
Unsealed	Yes	Yes	Yes	Test	0.68 – 0.80
Sealed	Yes	Yes	Yes	Yes	0.80 – 0.88

Source: NZ Building Code D1/AS1 2011. Also see notes below Table 16

Existing surfaces and alternative materials

Where existing surfaces are to be incorporated within a project, or where other surface materials are proposed, and they are not listed in Table 15 above, the values in Table 16 may be used. Any materials not listed are to be tested, and test results included in design reports.

Table 16: Slip resistance coefficients for pedestrian surfaces

Pedestrian surface	Level surface ¹		Sloping surface ² or stairs ³		Typical values for coefficient of friction (wet)
	Acceptable dry slip resistance	Acceptable wet slip resistance	Acceptable dry slip resistance	Acceptable wet slip resistance	CoF
Timber					
Uncoated smooth	Yes	No	No	No	0.20 – 0.35
Uncoated profiled ⁴ Along profile	Yes	No	No	No	0.15 – 0.20
Coated (paint, polyurethane, etc.)	Yes	No	No	No	0.10 – 0.30
Portland cement concrete					
Smooth trowelled finish Class U3 ⁶	Yes	No	Yes	No	0.30 – 0.45
Coated (paint, polyurethane, etc)	Yes	No	No	No	0.20 - 0.30
Marble & granite					
Polished surface ⁷	Yes	No	No	No	0.10 – 0.20

Pedestrian surface	Level surface ¹		Sloping surface ² or stairs ³		Typical values for coefficient of friction (wet)
	Acceptable dry slip resistance	Acceptable wet slip resistance	Acceptable dry slip resistance	Acceptable wet slip resistance	CoF
Honed finish ⁸	Yes	Test	Yes	Test	0.10 – 0.60
Fully sand blasted surface ⁹	Yes	Test	Yes	Test	0.30 – 0.50
Patterned sandblasted	Yes	Test	Yes	Test ⁹	0.15 – 0.45
Terrazzo					
Polished	Yes	Test	No	No	0.15 – 0.45
Honed	Yes	Test	Yes	Test	0.20 – 0.60
Ceramic tiles					
Unglazed					
Smooth finish	Yes	Test	Yes	Test	0.10 – 0.60
Profiled	Yes	Test ⁹	Yes	Test ⁹	0.10 – 0.65
Glazed					
smooth or polished finish ⁷	Yes	No	No	No	0.10 – 0.20
Profiled	Yes	Test ⁹	Yes	Test ⁹	0.10 – 0.45
Clay pavers					
Smooth texture	Yes	Test	Yes	Test	0.30 – 0.65
Compressed fibre-cement sheet					
Uncoated	Yes	Yes	Yes	Test	0.45 – 0.65
Coated (paint, polyurethane etc)	Yes	No	No	No	0.10 – 0.30
Coated and sand impregnated	Yes	Yes	Yes	Yes	0.55 – 0.90
Rubber tiles/ sheeting					
Smooth	Yes	Test	Yes	Test	0.20 – 0.60
Profiled	Yes	Test ⁹	Yes	Test ⁹	0.35 – 0.60
Vinyl & linoleum					
Smooth or with imprinted pattern	Yes	Test	Yes	No	0.25 – 0.50
Profiled (studs or ribs)	Yes	Test ⁹	Yes	Test ⁹	0.30 – 0.70
Grit/flaked finish	Yes	Test	Yes	Test	0.30 – 0.70

Notes to Tables 15 & 16:

- 1) Level surfaces including surfaces with slopes no steeper than 1:50.
- 2) Sloping surfaces with slopes greater than 1:50 but less than 1:10 for wet conditions, or less than 1:8 for dry conditions.
- 3) Acceptability as shown is based on stair treads without slip resistant nosings. When testing stair treads without nosings acceptability for slip resistance from AS/NZS 3661.1 should be based on a slope of 1:10. With slip resistant nosings at least 50 mm wide, acceptability criteria for stair treads is based on the requirements for level surfaces.
- 4) Profile at right angles to direction of pedestrian traffic. Algae growth on uncoated timber walkways significantly reduces slip resistance when wet and requires regular removal, e.g. by high pressure water blasting.
- 5) The sand/grit, which is sprinkled over the complete surface of the final paint coating, should be a hard, angular material such as silica sand or calcined bauxite. The particle size should not be less than 0.2 mm so that it is not submerged by the coating and not greater than about 2-3 mm, so that it remains tightly bound to the surface. If over painted, testing is required to establish acceptability of slip resistance.
- 6) Concrete surface finishes complying with AS/ NZS 3114.
- 7) Glazed or polished surfaces are unsuitable in either wet or dry conditions for sloping surfaces or for stairs, even though test measurements may indicate adequacy, because of the effect of foot placement. Note also that when tested in the dry, very smooth surfaces can give anomalous high readings arising from slip-suction effects between the test slider and the test surface.
- 8) The coefficient of friction can vary significantly with the extent of surface preparation.
- 9) It is noted in AS/NZS 3661.1 that the slip resistance tests prescribed in that standard may not be suitable for heavily profiled (or patterned) surfaces. The standard references other tests which may be more suitable for such surfaces.
- 10) When the grit finish has a "feel" rougher than 80 grit sandpaper, the surface may be deemed to have acceptable wet slip resistance, for either level or sloping surfaces or for stair treads, without testing.
- 11) Interlocking concrete block paving to AS/NZS 3116.
- 12) To meet durability requirements of NZBC B2, the surface should have at least a five-year life under normal maintenance.
- 13) Anti-slip tapes will normally require regular replacement to remain effective. To ensure foot contact, tapes should be placed at right angles to the line of travel and be spaced at no more than 150 mm centres.

Concrete footpaths

Footpaths in residential areas must be constructed with 20 mPa concrete from a registered manufacturing plant and must be at least 100 mm thick.

- Fibre reinforced concrete to Auckland Transport accepted specification is preferred.
- In cul-de-sac heads and non-residential areas, the footpaths including pram crossing must be at least 150 mm thick.
- Footpaths must be coloured using 4 kg of black oxide per m² added to the concrete.
- Footpaths must be laid on a 100 mm layer of compacted GAP 40 granular basecourse.

- Any non-standard concrete or paving on driveways, etc., must stop at the road reserve boundary, and the Auckland Transport Vehicle Crossing specification is required within road reserve.
- All concrete footpaths must be dosed with black oxide at the rate of 4%. Any other rate of dosing must be agreed via a Departure from Standard application.
- **Finish:** Exposed aggregate finish shall be used in high profile areas. Broom finish shall be used in all other areas.
- **Cure period:** All concrete must be membrane or water cured for five days before use. The footpath must be protected from vehicle wheel loads for 28 days.
- **Control joints:** Transverse control joints must be placed at maximum intervals of 3 m. Any saw-cut joints must reach one third of the thickness of the footpath. Saw cuts must be made no later than two days after the concrete has been cast. There must be no lips/steps greater than 5 mm at slab joints.
- **Vertical alignment:** To prevent vertical misalignment, movement by roots or heaving of ground, longitudinal contraction/expansion joints must be fitted with shear dowels.
- **Chamber lids** must be levelled to suit the cross-fall. They should be flush with the surrounding surface area, with a step of no more than 5 mm.
- **Stitching:** To prevent cracking at re-entrant corners, manhole chambers, light poles, etc., the slab must include diagonal 16 mm diameter stitching bars at each corner. Bars must be 900 mm long, fitted centrally into the slab depth. If using fibre reinforced concrete, these bars can be omitted.
- **Local and neighbourhood centres:** For high-quality concrete footpaths in local and neighbourhood centres, concrete slabs should be structurally designed to keep crack widths to a maximum of 0.2 mm.
- **Shrinkage:** Light poles, manholes, foundations, or large structures embedded in the slab also prevent free shrinkage, causing cracks. The addition of rebar can control cracking to reasonable widths, but this may require careful analysis of the tensile stresses involved.

Footpaths in Main streets, mixed-use streets and centres

- **Thickness and compaction:** This should be at least 150 mm thick laid on 100 mm layer of GAP 40 compacted granular basecourse.
- **Control joints & mesh:** As in Section 3.4.2.6: *Footpath surfaces and construction*.
- **Type:** Exposed aggregate finishes are expected in these important locations and can be considered up to the boundary of the centre.
- **Pavers - Thickness and compaction** A minimum thickness of 60 mm is needed for interlocking concrete pavers, constructed on 30 mm of compacted bedding sand. The bedding sand must be laid on a 150 mm layer of GAP 40 compacted granular basecourse. In non-residential areas, the GAP 40 compacted granular basecourse layer must be at least 200 mm thick. The basecourse layer depth must be increased for weak subgrade (CBR < 3). Pavers also need to be installed as per manufacturers specifications
- **Vehicle areas:** See Section 3.9: *Pavement and surfacing*.

Asphaltic concrete footpaths

Use NZTA Mix 10 constructed with a compacted depth of 20 mm. The mix must be laid on a 150 mm layer of compacted GAP 40 granular basecourse. In cul-de-sac heads and non-residential areas under the footpaths, the compacted GAP 40 granular basecourse layer must be at least 200 mm thick. The basecourse layer depth must be increased for weak subgrade (CBR < 3).

Edging must be a minimum of 100 mm by 25 mm H4 treated timber edge boards. These are to be staked at a maximum spacing of 500 mm with 30x30 mm H4 pegs with a minimum length of 225 mm.

Hoggin

- **Thickness and compaction:** A thickness of between 35-50 mm of self-binding gravel, constructed on a 150 mm layer of GAP 65 compacted granular basecourse. The basecourse layer depth must be increased for weak subgrade (CBR < 3).
- **Drainage:** Granular metal surface is susceptible to surface water scour. Do not use where gradient exceeds 8%.

3.4.2.7 Pedestrian facilities

Kerb crossings

A kerb crossing (or pram ramp) can be any form of dropped kerb or at-grade arrangement to allow wheeled equipment such as prams, wheelchairs or mobility scooters to move safely from a footpath to cross a carriageway.

The recommended gradient for kerb crossings is 5%, with a Preferred maximum grade of 8.33%. In exceptionally tight situations, a maximum grade of 12.5% may be used with the approval of the Auckland Transport Chief Engineer.

- **Kerb ramp and build-out:** A minimum through route width of 1.5 m must be allowed behind the kerb ramp
- **Flush:** All kerb and pedestrian crossings at the edge of ramps must be finished flush with channels and other interfaces
- **Other guides:** Design and construction of kerb crossings must be in accordance with NZTA *Pedestrian planning and design guide*, Section 15 and Table 15.2
- **See detail:** See Auckland Transport TDM SED FP0006 for kerb crossing details.

Tactile ground surface indicators (TGSIs) and visual aids

Auckland Transport has adopted “safety yellow” as the standard colour for all TGSIs.

TGSIs on slopes/ramps must have an average coefficient of friction of no less than 0.6.

All new, modified or upgraded kerb crossings must be as per RTS 14: *Guidelines for facilities for blind and vision-impaired pedestrians* and NZS/AS 1428.4.1¹⁴. Also see SED FP0006¹⁵.

There are two types of TGSIs:

- Directional Type C TGSIs (“leading tactiles”) consist of a series of raised bars installed to the walking surface, oriented in line with the prescribed direction of travel.
- Warning Type B TGSIs (“hazard” or “decision” tactiles) are installed to the walking surface in a raised grid pattern of domes or studs. Warning TGSIs are intended to function much like a stop sign.

3.4.2.8 Pedestrian crossings

Pedestrian crossings are facilities provided to help pedestrians cross carriageways.

- **Controlled pedestrian** crossings should not be located:
 - Within 80 m of another controlled crossing, except on different legs of intersections
 - Between 20 m and 100 m from an intersection, unless signal controlled as an offset phase of a signal intersection.
- **Kerb build-outs:** Build-outs on Neighbourhood, Mixed-Use and Main Street Collector types shall have a maximum clear distance of 6.4 m kerb-to-kerb. Approaches and at the crossing itself, must be as per the Ministry of Transport’s *Land Transport Rule: Traffic control devices 2004*.
- **Standards:** Design and construction of pedestrian crossings must be in accordance with:
 - Auckland Transport *Urban street and road design guide*
 - NZ Transport Agency *Pedestrian planning and design guide*, Section 15 and Section 6.5. (The latter has specific guidelines for selecting the appropriate pedestrian crossing facilities.)
 - Austroads *Guide to road design*, Part 4 – Intersections and crossings – General.
- **Markings:** All pavement markings and signs including delineation (e.g. marker posts) on the approaches and at the crossing itself, must be as per the *Land Transport Rule: Traffic Control Devices 2004*.

Controlled pedestrian crossings

Zebra crossings are marked by white painted strips on a red, black or dark grey surface across the road and flashing amber beacons or reflective discs mounted on black and white poles. A white limit line must be marked if practicable, to show motorists where to stop. White diamonds are painted on the road before the crossing as advanced warning.

- Zebra crossings should be installed on raised tables
- Zebra crossings may incorporate school crossing patrol facilities at sites approved by Auckland Transport

¹⁴ *Design for access and mobility – tactile ground surface indicators*

¹⁵ Footpaths drawing index: Pram crossings <https://at.govt.nz/media/1982215/footpaths-pedestrian-facilities.pdf>

- Zebra crossings should not be located where the speed limit exceeds 50 km/h, except with specific approval from the NZTA.

See Section 3.7: *Traffic calming*, for additional details.

Kea school crossings provide a safe place for children to cross the road under the control of a school patrol while the kea crossing is operating. Kea crossings must be installed as per NZTA School Crossings¹⁶.

Uncontrolled pedestrian crossings

Platform type pedestrian crossings must be flush with footpath or include platform/footpath ramping transitions for the smooth passage of prams, wheelchairs and mobility scooters. See Section 3.4.2.7: *Kerb crossings*, for details.

It is vital that pedestrians do not mistake the platform as a continuation of the footpath. Crossings can be distinguished by:

- Surfacing materials with different texture and contrast
- A white concrete beam between the edge of the platform and the footpath
- Bollards or other street furniture.

Tactile warning indicator paving must always be provided along the footpath near the boundary with the platform.

Warning sign PW-39 should be installed except where local area traffic management design does not require this.

3.4.2.9 Pedestrian refuge islands

Pedestrian refuge islands provide a place where pedestrians can stop part-way across a wide two-way or multi-lane road.

- **Dimensions:** Pedestrian islands should have an island width of 1.8 m or more (minimum depth of 1.4 m) and a minimum passage width of 2.0 m.
- **Construction:** Pedestrian islands must be built as kerbed islands 150–180 mm above the road surface and contrast with the road. On routes used by over-dimensional vehicles, the island kerb height should be restricted to 100 mm and mountable kerb profile used. Removable street furniture should be provided.
- **Guidance on islands:** See also Section 3.3: *Urban and rural roadway design*, for in-situ and pre-cast concrete island details and kerb profiles.
- **Plants:** If they are large enough, low plants (growing to no more than 0.6 m high) that do not obscure children or signage may be planted. See Section 3.6.10: *Landscaping*, for acceptable plant heights and types.

¹⁶ <https://www.nzta.govt.nz/walking-cycling-and-public-transport/walking/walking-standards-and-guidelines/pedestrian-network-guidance/design/crossings/school-crossings/>

- **Layouts:** The three pedestrian island layouts commonly used are straight, diagonal and chicane:
 - Straight is preferred for a stand-alone pedestrian island
 - Diagonal may be appropriate in some road environments, where pram ramps on opposite sides of a street cannot be aligned at right angles. This layout should not be used where a straight layout can
 - Chicane design requires a wider island. This design should incorporate safety fencing, which can itself present a safety hazard under vehicle impact. Also, the fencing increases maintenance demands. It provides waiting space for more users and is required for two-stage signal controlled crossings.
- **Kerb crossings:** Where there are pedestrian islands, kerb crossings must be provided to adjacent footpaths.

3.4.3 Trees and planting

This section should be read in conjunction with the Auckland Council *Code of practice for land development and subdivision, Chapter 7: Landscaping*.

3.4.3.1 Landscape and planting guidance

Plants are considered in these categories:

- Trees (3 m+)
- Shrubs (0.5 - 3 m)
- Ground covers (0.1 - 0.5 m)
- Seasonal flowers (0.00 - 0.10 m).

Ground level planting

- Generally, keep all areas between 0.9 m and 1.75 m above ground level free of visual obstructions.
- Provide apron or other feature to prevent spreading vegetation from encroaching beyond the kerblines. Set-back of 0.6 m generally recommended.

Grassed areas

- Grassed slopes should not exceed 20% (1:5) gradient for safety when mowing. A minimum of 750 mm at top of slopes or 500 mm at toe of slopes must be level (2% - 8% grade) for safety and maintenance, adjacent to paths.

Covered tree pits

- The tree grate or pit cover should respond directly to local character. They are not always suitable for wide branching trees and narrow, long tree pits can distort or stunt tree growing conditions.
- Grates or covers should be 'heelsafe' and avoid trip hazards.

Raised and flush planted median islands.

- Plantings must be low shrubs and/or ground covers not exceeding 0.5 m in height or trees limbed up to offer clear sight lines from street pavement level to 2.0 m.

Raised planters

- Keep planter height to a maximum of 1 m, to avoid visual obstructions and risks to personal safety.
- Visibility over and through planters is important. Generally, keep all areas between 0.9 m and 1.75 m (eye height for children and adults) free of visual obstructions wider than 300 mm.

Vertical planting structures

- Structural engineering design and building consent needed. Wall-based plantings must not block essential sight lines for users.

Parklets

Parklets offer areas of relaxation or social interaction. They are usually constructed of material that is easy to assemble, such as timber, metal and moveable elements such as large ceramic or concrete planters:

- Ensure pedestrian safety
- Ensure that vehicle overhangs and turning path requirements are fully accommodated.

3.4.3.2 Landscape and planting standards

This section provides supplementary guidance for planting in road reserves.

Landscape and planting in road reserves should comply with the Auckland Council *Code of practice for land development and subdivision, Chapter 7: Landscaping*, with the supplementary Auckland Transport standards provided below.

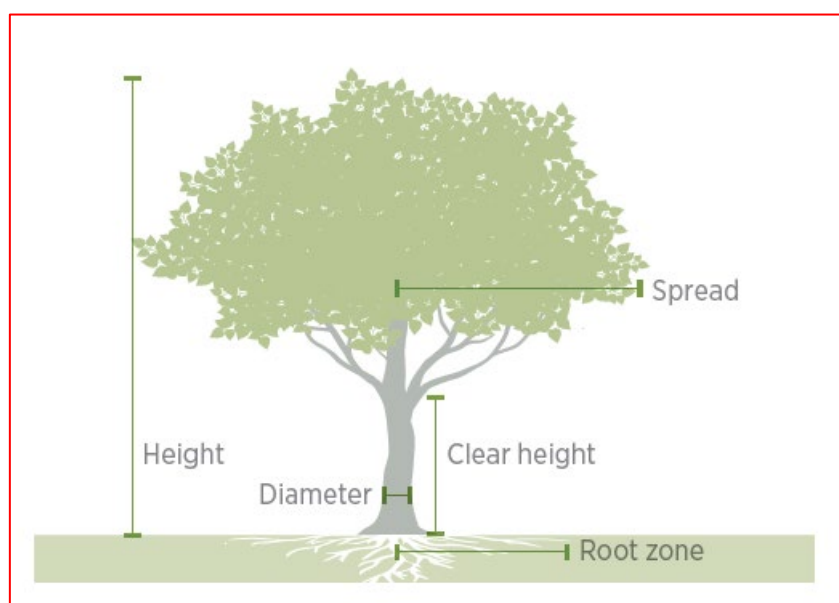

Figure 7: Tree with definition labels

Planting for stormwater management

Where planting is required to perform a stormwater management function, or can usefully contribute to this, it shall comply with Auckland Transport *Bioretention Planting Guide*, 2021.

Clearance envelopes

Position street trees so:

- Height clearances of 4.5 m (measured from the carriageway surface at the kerb-line) can be maintained above traffic lanes when the trees are mature
- Height clearances of 3.0 m (measured from the carriageway surface at the kerb-line) can be maintained above parking bays or local street parking shoulders when the trees are mature
- Height clearances of 2.5 m (measured from the footpath and cycleway surface) can be maintained.

Set trees back no less than 0.6 m from the front of kerb. Over-dimensional routes require height clearances of 6.5 m and width clearances of 11.5 m.

The edge of raised planters constructed in sealed berms should be positioned no closer than 0.6 m from the outer face of the kerbing. Mature spread should have minimum clearance of 2 m from buildings and 1 m from canopies and verandas. Clearance envelopes are shown in the Auckland Transport TDM SED GD0000 series.

Utilities

Underground and overhead utility services may be impacted by vegetation, specifically roots and canopy:

- Protection of utilities from root damage is required for any trees within 1 m of underground utilities
- Minimum 2 m from manholes, drainage catchment and underground services surface openings
- Minimum 3 m away from low voltage power poles and 5 m from high voltage poles, transformers and transformer poles
- Minimum 4 m away from high-pressure gas pipelines
- Minimum 2 m away from Watercare Services' pipelines over 300 mm in diameter.

Sight lines

Within these sight line envelopes ground cover is to be below 0.6 m, trees should be limbed up to at least 1.75 m above ground or to a height that avoids obstructing signs.

3.4.4 Street furniture

This section introduces, defines and explains the range of streetscape components that influence the use, look and feel of the street for all users.

All street furniture must be designed and located in accordance with universal design criteria.

Bus shelters

For detailed guidance on bus shelters, see Section 3.6: *Public transport– Bus infrastructure*.

Cycle racks and lockers

Detailed guidance on these features can be found in the *Engineering design code - Cycling infrastructure*.

Seating and tables (fixed)

Benches and seats for rest should ideally be placed every 50 m, particularly in urban areas adjacent to commercial and retail activities (e.g. town centres), and routes to public buildings such as hospitals and libraries.

Minimum clearances between seats and other streetscape components include:

- 600 mm minimum distance from front face of kerb (700 mm on double-decker bus routes)
- Placement and spacing of seating should consider dimensions required when occupied and generally allow 750 mm space for users in front of the seating element, clear of the through route
- 600 mm clearance from tree pits
- 1000 mm clearance from other street furniture elements.

Seats, benches and tables are typically made of durable, easily maintained materials such as timber, concrete, metal or man-made materials.

Also consult:

- Area-Specific Street Furniture Suites, e.g. City Centre, Waterfront, Henderson/New Lynn
- Auckland City Council (2010): *Great streets – A streetscape design guide for the CBD*
- Auckland Council (2012 under development): *Auckland design manual*
- NZ Transport Agency (2007): *Pedestrian planning and design guide* (formerly Land Transport New Zealand).

Table 17: Preferred permanent benches, seats and tables (fixed)

Preferred locations and orientation	Acceptance criteria
Bench	
Street furniture zone	Non-corroding metal frame or base
Plazas	Hardwood slats resistant to sun and rain
Park edges	Easily replaced
Adjacent to public buildings and services	Concrete
Sunny location	Stone
Under tree canopy not advised, due to bird droppings	Anchored/attached to concrete footings
Seat	
Street furniture zone	Non-corroding metal base or frame
Plazas	Hardwood slats (preferred) resistant to sun and rain
Adjacent to public buildings and services	Concrete
Sunny location	Stone
Under tree canopy not advised, due to bird droppings	Galvanised or stainless hardware
Table	
Street furniture zone	Hardwood slats (Preferred) resistant to sun and rain
Plazas	Easily replaced
Park edges	Concrete
Adjacent to public buildings and services	Stone
Sunny location	Galvanised or stainless hardware
Under tree canopy not advised due to bird droppings	Non-corroding metal frame or base

3.4.4.1 Seating and tables (moveable)

Moveable furniture is usually used in a designated public area during periods of high demand. Ensure a clear through route is maintained with a 1.8 m minimum width and at least one legible edge, preferably along the frontage side. Width may need to be greater, if more than 60 pedestrians/min are expected.

Table 18: Preferred seats, benches and tables moveable

Preferred locations and orientation	Acceptance criteria
Bench	
Street furniture zone	Lightweight metal such as polished aluminium or equivalent
Plazas	
Park edges Adjacent to public buildings and services	Prefer hardwood slats style resistant to sun and rain and is easily replaced
Sunny location	
Under tree canopy not advised, due to bird droppings	
Seat	
Street furniture zone	Lightweight metal such as polished aluminium or equivalent
Plazas	
Park edges Adjacent to public buildings and services	Prefer hardwood slats style resistant to sun and rain and is easily replaced
Sunny location	
Under tree canopy not advised, due to bird droppings	
Table	
Street furniture zone	Lightweight metal such as polished aluminium or equivalent
Plazas	
Park edges Adjacent to public buildings and services	Prefer hardwood slats style resistant to sun and rain and is easily replaced
Sunny location	
Under tree canopy not advised, due to bird droppings	

3.4.4.2 Outdoor dining and place space

The provision and placement of outdoor dining should not reduce pedestrian through-movement or safety and should prevent the privatisation of public space.

It is possible to provide for smaller format outdoor dining in narrower streets subject to minimum clearances:

- 600 mm minimum width for outdoor dining zone
- 600 mm minimum clearance from the front face of the kerb (800 mm on all bus routes)
- 2000 mm minimum clearance for pedestrian clear zone, greater in the city centre and other areas of high foot traffic
- 500 mm minimum offset from tree pits, bollards and poles
- 1000 mm minimum clearance from other street furniture items including public benches, bins, bike racks, payphones, parking meters and bus stop shelters

- Clearance breaks of 2000 mm minimum gap between outdoor dining zones of 12 m or greater in length.

For more detailed guidance, see:

- Auckland Transport/Auckland Council, Trading and Events in Public Places Bylaw, 2015
- Melbourne City Council *Outdoor cafe guide*.

3.4.4.3 Shade structures (fixed)

Fixed shade structures provide shade and rain protection on a permanent basis. Typically, permanent shade structures are either attached to a building or are free standing in open space areas near the street.

Table 19: Preferred shade structures: Fixed

Preferred locations & orientation	Acceptance criteria
Sun shades	
Street furniture zone	Non-corroding metal frame or base
Plazas	Hardwood slats resistant to sun and rain
Park edges	Concrete
Adjacent to public buildings & services	Stone
Sunny location	Anchored / attached to concrete footings
Canopies	
Street furniture zone	Non-corroding metal base or frame
Plazas	Hardwood slats resistant to sun and rain.
Park edges	Concrete
Adjacent to public buildings & services	Stone
Sunny location	Galvanised or stainless hardware
Umbrella	
Street furniture zone	Hardwood slats resistant to sun and rain.
Plazas	Concrete
Park edges	Stone
Adjacent to public buildings & services	Galvanised or stainless hardware
Sunny location	Non-corroding metal frame or base

3.4.4.4 Shade structures (moveable)

Flexible and moveable shade structures can be used to provide shelter from sun and rain in designated locations and placed as required in periods of high demand.

Table 20: Preferred shade structures: Flexible

Preferred locations and orientation	Acceptance criteria
Umbrellas	
<ul style="list-style-type: none"> • Street frontage and/or furniture zone • Plazas • Park edges • Adjacent to public buildings & services • Sunny location • Under tree canopy not advised, due to bird droppings 	<ul style="list-style-type: none"> • Lightweight metal such as polished aluminium or tubular stainless steel • Hardwood frame resistant to sun and rain • Bright and reflective coloured fabrics in durable materials
Shade structures	
<ul style="list-style-type: none"> • Street frontage and/or furniture zone • Plazas • Park edges • Adjacent to public buildings & services • Sunny location • Under tree canopy not advised, due to bird droppings 	<ul style="list-style-type: none"> • Lightweight metal such as polished aluminium or stainless steel or galvanised metal • Bright and reflective coloured fabrics in durable materials

3.4.4.5 Signage (temporary)

This section primarily relates to sandwich board advertising signs and temporary directional or event signs.

A minimum clearance of 1 m (rather than the standard 1.8 m) is permitted adjacent to the through route, but only for the distance occupied by the sign. This is to be increased to 1.8 m where footpath through route is 2.4 m.

3.4.4.6 Banners and flags

Banners and flags include informational and artistic flag-like elements for public display, printed onto cloth or synthetic lightweight flexible material.

In terms of the Land Transport Rule: *Traffic control devices* 2004¹⁷, commonly known as the TCD rule, banners and flags must not be attached to traffic signal poles.

¹⁷ <https://www.nzta.govt.nz/resources/rules/traffic-control-devices-index/>

3.4.4.7 Public art

Public art can enhance the visual vibrancy of roads and streets, convey important messages about local history, values and complement or improve the appearance of existing built form.

Should be located to meet the needs of the viewing audience, The placement of proposals for sculpture or other artworks that may pose physical obstacles within the streetscape need to be considered in the same way as any other streetscape component, including keeping clear of pedestrian movement in the through-route and not presenting a roadside hazard to motorists.

Make sure the installations are easy to maintain, refurbish and repair.

3.4.4.8 Kiosks

Kiosks are structures that provide information about local routes, attractions, services or offer refreshments.

Locate kiosks in highly visible locations that do not create visibility issues for vehicles and pedestrians, or crime prevention through environmental design (CPTED) concerns.

Kiosks should be designed to the following guidelines:

- When more than one kiosk is installed on a street, all kiosks should be of the same, or complementary design and scale
- Kiosks can be artistic and expressive. They should reflect an area's special character through their design and can be integrated with public art
- Building design should maximise active and well-articulated frontages to add visual interest and contribute to the vibrancy of the street.

3.4.4.9 Drinking fountains

Drinking fountains are a public amenity of value in high pedestrian activity areas including around public transport stations, well populated civic spaces and major recreational routes such as coastal and park edge streets.

Allow sufficient clearance (1000 mm) for use without obstructing pedestrian movement within the clear route, and 1000 mm clearance from other street furniture items.

All drinking fountains should be accessible to all users, particularly children and people in wheelchairs.

Auckland Transport is currently collating a range of standard drinking fountains with criteria for use across Auckland.

3.4.4.10 Water features

Water features provide a focal point in a streetscape environment or can be an amenity feature creating both auditory and visual interest.

Appropriate location can depend on the form of the water feature. However, the following general considerations apply:

- Water feature edges must be clearly defined and located away from through routes
- Water features must be located in areas that get lots of sun for greater effect and potentially lower maintenance costs
- Assess other related projects likely to impact the design space under review. This can include future street furniture, bus stops, changes in kerbside parking, new below grade utilities, etc. or new activities requiring access. It is critical to identify and fully address potential deflected water/spray from high wind speed conditions.

Use robust and durable materials with reliable detailing. The feature must be easy to maintain, refurbish and repair. Select materials which are resilient to water and that do not stain easily or are costly to clean.

Water features are often public art (Section 3.4.4.7).

3.4.4.11 Pedestrian lighting

Lighting plays an important role in providing for the safety and security of all street users at night.

Generally locate all pedestrian lighting poles within the kerb or street furniture zone. Non-pole fixtures will typically be either up-lighting or down-lighting from fixtures attached to buildings and other solid elements.

Up-lighting will require specific design to avoid safety issues.

Other guides:

- See Section 3.12: *Street lighting*, for full details of street lighting including lighting levels, performance standards and lighting types
- NZ Transport Agency: *Pedestrian planning and design guide*, Section 17-1/3.

3.4.4.12 Wayfinding signage

Wayfinding signs include direction signs, way marks, information boards and interactive screens for residents and visitors. This includes directional and wayfinding signage, information panels and interpretative signage

Other guides: See also Auckland Transport TDM: *Wayfinding and signs design guide*.

All types of streetscape signage should be placed in accordance with the general guidelines stated in Section 2 (e.g. consistent location in the street furniture zone, or co-ordination and co-location with other streetscape elements). In addition, they should:

- Be located in the street furniture zone and as near to intersection corners as is practicable (but outside of the corner clear zone)
- Share existing poles where possible consistent with the signage design, or be designed as an integral streetscape element
- Maintain minimum clearances of 600 mm from the front face of the kerb (800 mm on all bus routes).

Signs should be placed such that sign faces can be read within the normal field of vision of users.

- Signs intended for viewing close up should be mounted on walls or other structures 0.9 m to 1.5 m above the ground
- Pole signage should be 2.5 m above the ground, with information tailored to be read at some distance away
- Information panels should be located with the signage face perpendicular to the kerb, with a minimum offset of 600 mm from the kerb face (800 mm on all bus routes)
- Wall mounted information boards with timetables and maps should be centred approximately 1400 mm from the footpath surface and should be placed such that pedestrians will not walk into the sign face or its edges.

See also NZ Transport Agency: *Pedestrian planning and design guide*. Appendix 3: Sign face design details.

3.4.4.13 Barriers, railings, fences and bollards

Barriers, railings, fences and bollards are used to guide or restrict movement.

Railway crossings

Pedestrian railings for level railway track crossing points must comply with New Zealand *Cycle trail design guide*, Section 5.5, *Railway crossings*¹⁸.

Vehicle restraint

Fences or barriers to prevent a vehicle from leaving the carriageway are covered in Section 3.3: *Urban and rural roadway design*.

Railings

Railings are not classified as a road restraint device. The spacing of both posts and rails is usually of a composition to deter people movement through the railing but is not sufficient to provide fall prevention.

¹⁸ Ministry of Economic Development, August 2011 (2nd Ed).

Fences

May serve several purposes:

- Safety fences to restrict access to unsafe locations (also see Barriers above)
- As required to meet the requirements of the Fencing Act, e.g. on reinstating a boundary fence that has been affected by works in the road reserve
- For amenity purposes for visual screening.

Bollards

Primarily a safety element to separate pedestrians or streetscape elements from vehicles. Bollards should only ever be used as a last resort.

They should be located in the kerb zone, but with a sufficient setback to accommodate vehicle overhang, and may not interfere with vehicle, cyclist or pedestrian sight distance.

Bollards should be placed at the edge of defined spaces, e.g. between outdoor dining and through routes or between areas where vehicles may and may not go.

Should be designed so as not to constitute a hazard for road users.

Catering for the visually impaired

Must be designed, constructed and maintained in accordance with the following general requirements:

- Where a pedestrian facility is at a height above ground of 1 m or greater, then a barrier or fence (“barrier” in New Zealand Building Code terminology) must be installed in compliance with Clause F4¹⁹, New Zealand Building Code. For pedestrians the fence height must be at least 1100 mm
- Where cyclists may use a path on a bridge and the bridge height above ground is greater than 2 m, a bridge barrier (“barrier” in NZTA Bridge manual terminology) must be installed in compliance with Section B of the NZTA Bridge manual. The barrier height must be at least 1400 mm
- The construction of the railing must be frangible and must not create hazards (e.g. spearing risk, flying debris such as splintered timber) when a vehicle crashes into it
- Guardrails should deter climbing, and gaps between elements should be less than 100 mm
- The construction or placement of guardrail should not obscure visibility to children waiting to cross a road
- Any timber materials must be treated to H4
- For ease of replacement, the structure must comprise a series of relatively short sections (max. 2.5 m).

¹⁹ Buildings are constructed to reduce the likelihood of accidental fall

Other guides

Fences must comply with the following:

- Clause F4 Safety from Falling, New Zealand Building Code
- NZ Transport Agency *Bridge manual*, Section B: *Bridge side protection* (in particular Clause B6.3 Pedestrian and cycle barrier)
- All such handrails must comply with Clause D1, Handrails on stairs – New Zealand Building Code and the structures section (in particular handrails/parapets on bridges and other structures)
- Pedestrian railings are covered in this section
- Cycle railings are covered in Section 3.5: *Cycling Infrastructure*.

Table 21: Preferred bollard designs

Preferred locations & orientation	Acceptance criteria
Bollard	
<ul style="list-style-type: none"> • Street furniture zone • Non-critical edges to through routes 	<ul style="list-style-type: none"> • Not conflicting with universal design criteria

3.4.4.14 Public toilets (permanent)

Permanent public toilets provide attractive and easily maintained amenity for areas of heavy pedestrian traffic.

Minimum spacing and clearances must be maintained:

- Freestanding public toilets are not permitted on pavements less than 3.5 m wide, or on any pavement on which their placement would obstruct the minimum through-route allowing for a minimum 900 mm clearance between opening doors and the clear zone to allow ease of use outside of the clear zone
- Where possible, units should be placed such that cubicle entrances do not open directly onto the main clear zone for pedestrian movement
- Public toilets in streets should be located in the street furniture zone, a minimum of 600 mm from the outside edge of the kerb (800 mm on all bus routes)
- Public toilets should be placed a minimum of 1000 mm from existing or other street furniture elements such as street trees, benches and lighting poles.

3.4.4.15 Public toilets (temporary)

Temporary toilets are typically installed during periods of high demand or when existing permanent facilities are under repair or renewal.

The positioning of temporary toilets is controlled by Auckland Council. Single or grouped units must be placed on a firm, level standing. Where possible, units should be secured to prevent tipping due to wind or mischief.

3.4.4.16 Litter bins (fixed)

Fixed litter and recycling bins for rubbish generated largely by pedestrians intercepts unwanted rubbish from streets, improves the visual quality of public spaces and reduces maintenance costs.

Bins should be located within the street furniture zone. Along shopping and town centre streets with high foot traffic and areas where people congregate, bins should be provided at regular intervals, ideally every 50 m.

Minimum clearances between stand-alone bins and other streetscape components include:

- 600 mm minimum distance from the front face of kerb (800 mm on all bus routes)
- 1000 mm clearance from other street furniture elements.

Bins should be robust, functional and of a simple design. They are typically constructed from timber, metal or plastic or combinations of these materials.

3.4.5 Utilities and services

Grates

Grates for drainage channels and for ventilation may have a functional need to be located in the footpath but are generally found in the berm or carriageway.

Grates within or immediately adjoining through route shall be Heelsafe types.

See Section 3.11: *Road drainage*, for technical guidance on footpath drainage

Automatic teller machines

Locate ATMs in highly visible locations and address all Ministry of Justice Crime Prevention through Environmental Design (CPTED) concerns. Allow adequate space around the ATM to ensure that users do not impede the through route.

Power poles

Power poles should be placed within the street furniture zone parallel to the kerb. Placement of power poles must comply with the minimum setback requirement of 700 mm from the kerb face to the near side of the pole as indicated in Section 3.12: *Street lighting*.

Underground services

Design teams should consider the best placement of signal control boxes to minimise their physical and visual impact on the streetscape. It may sometimes be appropriate to place control boxes at the back of the street in the property frontage zone.

Where control boxes are to be placed against buildings or property boundaries, they should not obstruct private property including doorways, access ways or shop windows, or cause a hazard to pedestrians.

Parking meters

Provision of parking meters is overseen by Auckland Transport's Parking and Enforcement Department. Also see Section 3.8: *Parking design*.

Utility cabinets

Design teams should consider the best placement of signal control boxes to minimise their physical and visual impact on the streetscape. It may sometimes be appropriate to place control boxes at the back of the street in the property frontage zone.

Where control boxes are to be placed against buildings or property boundaries, they should not obstruct private property including doorways, access ways or shop windows, or cause a hazard to pedestrians.

Post boxes

Post boxes are not the responsibility of Auckland Transport and are designed, installed, serviced and maintained by postal service providers.

Post boxes should be placed consistently within the street furniture zone.

The edge of the unit should be 600 mm from the front face of the kerb (800 mm on all bus routes), at least 750 mm from the through route and 1000 mm from other furniture.

Telephone boxes

Telephone boxes are not the responsibility of Auckland Transport and are designed, installed, and maintained by telecommunication providers.

Designers should ensure that there is space around telephone boxes (1850 x 2100 mm) for wheelchair access.

Telephone boxes should not be installed on footpaths less than 3.5 m wide. The edge of the unit should be 600 mm from the front face of the kerb (700 mm on double decker bus routes) and at least 750 mm from the through-route.

Service covers

Service inspection covers are often located in the footpath to meet a functional need. Care must be taken to ensure their placement is integrated with the design of footpath surfaces and that their installation does not pose an obstacle or trip hazard for pedestrians.

The use of covers with paving inlay can be considered in paved areas of high architectural value. These must be approved by the service asset owner as they may require special lifting gear. Weight and cost must be considered.

Manholes and other service access covers, and grates should ideally be located within the frontage or street furniture zone outside of the through-route.

Service covers are to be branded and painted as follows:

- Fire hydrant: FH and painted yellow
- Water valve: V and painted white
- Water meter: METER, unpainted.

Other guides

- Auckland Utility Operators Group: *Code of practice for working in the road*, 2003

3.5 Cycling and infrastructure

Cycling infrastructure includes facilities that are dedicated for cycle use, as well as specific standards for general infrastructure to meet the needs of cycle users.

3.5.1 Choosing the right facility

For cycle parking, and manoeuvring of cycles at very low speed, use the dimensions in Table 22 below.

Table 22: Cycle parking and manoeuvring at low speeds: Minimum dimensions

Type	Width (mm)	Length (mm)	Min. turning circle (mm)	
			Outer radius	Inner radius
Conventional bicycle	700	1800	1650	850
Tandem	700	2400	3150	2250
Bicycle and trailer	800	2700	2650	1500
Cargo trike	1200	2600	2300	100

Note: a wide range of adapted bikes are used for disability cycling: their design requirements will generally fall within the ranges in this table

Design speed will vary with path type and with spatial context.

- **Express networks:** Where there are frequent interruptions, changes of direction or mixture of user types, a design speed of 20 km/h or less may be appropriate. For longer, uninterrupted, and homogenous user sections, a design speed of 30 km/h may be appropriate but check for safe stopping and turning at the maximum likely speed for users.
- **Local networks:** Use a design speed of 20 km/h but check for safe stopping and turning up to 30 km/h (the maximum speed for vehicular traffic).
- **Intersections and crossings:** 10 km/h may be acceptable in most cases unless cyclists have priority. Cyclists lose stability at less than 10 km/h so the design speed should not be less than that, except when braking to a stop.

Types of cycle facility:

- Facilities within the road corridor
- Off-road paths.

Approved cycleway types:

- **Express networks** are major cycleways on busy streets or off- road paths
- **Local networks** are both on and off-street.

3.5.2 Approved facilities within the road reserve

3.5.2.1 Separated cycleway (busy, fast, or heavy traffic)

Use these approved types.

Table 23: Criteria for separated cycleways (busy, fast or heavy traffic)

Lanes	>2 lanes (peak or permanent) or
Vehicle Flow	>5,000 vpd or >500 vph, or
Speed	85th %ile >50 km/h, or
Heavy vehicles	Frequent/Rapid PT network or >4% HCV

*Minimum dimensions may be accepted by Departure. Less than minimum will need to demonstrate compliance with design principles and a Departure may be denied.

- Two-way facilities (3.2 m minimum).
- A minimum 1.2 m separator may be suitable if no safety or public realm issues are present
- A minimum 1.8 m cycleway may be suitable if no safety or public realm issues are present
- A wide separator allows flexibility of use.

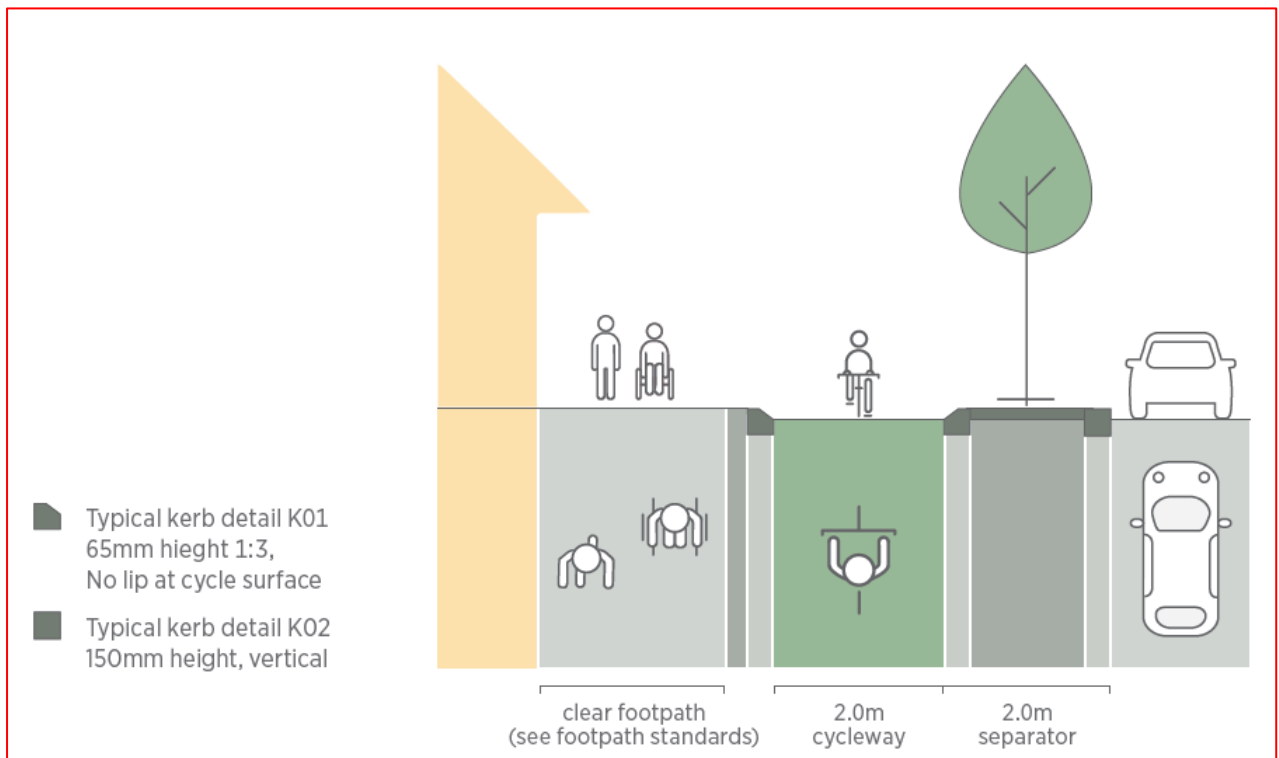

Figure 8: Approved design option 1

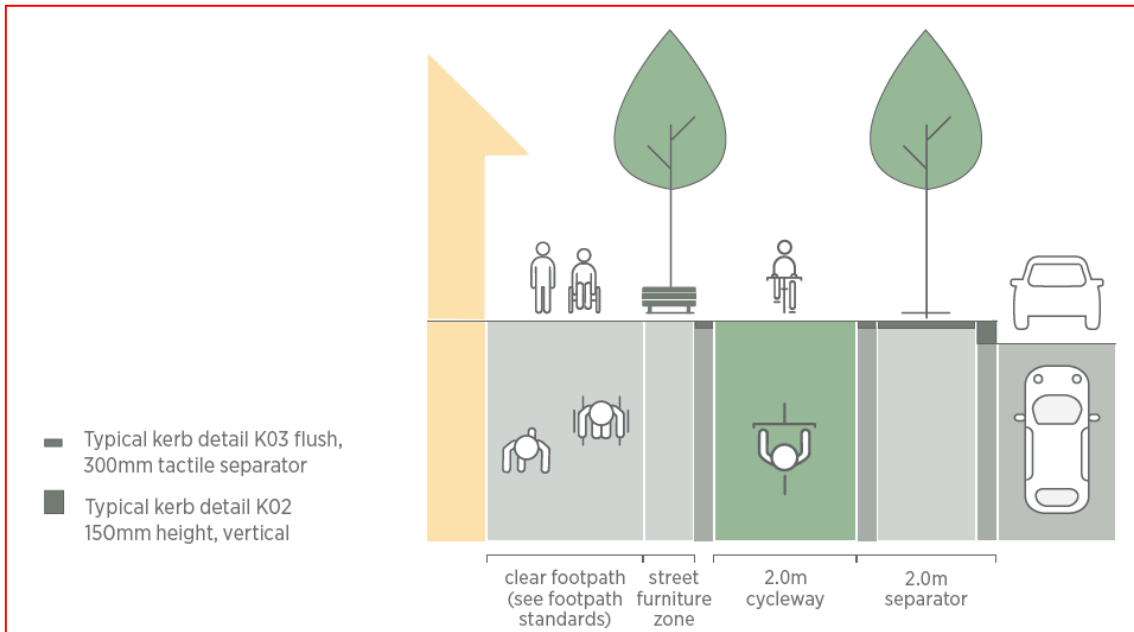

Figure 9: Approved design option 2

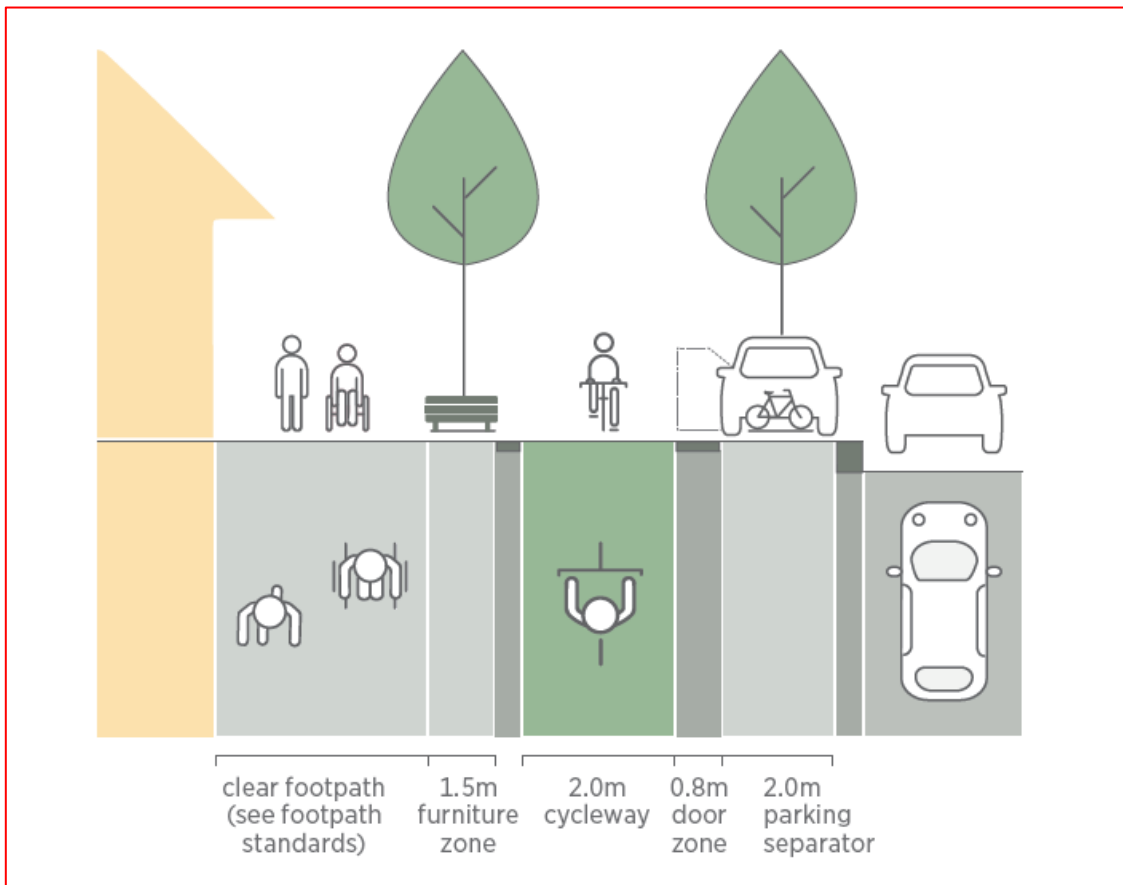

Figure 10: Separator with parking

3.5.2.2 Separated cycleway (low volume and slow traffic)

May use the following approved types if all of these criteria apply.

Table 24: Criteria for separated cycleway (low volume and slow traffic)

Lanes	Maximum 2 lanes (peak or permanent) and
Vehicle Flow	3,000 - 6,000 vpd or 300-600 vph, and
Speed	85th %ile <40 km/h, and
Heavy vehicles	Local or no PT network and <4% HCV

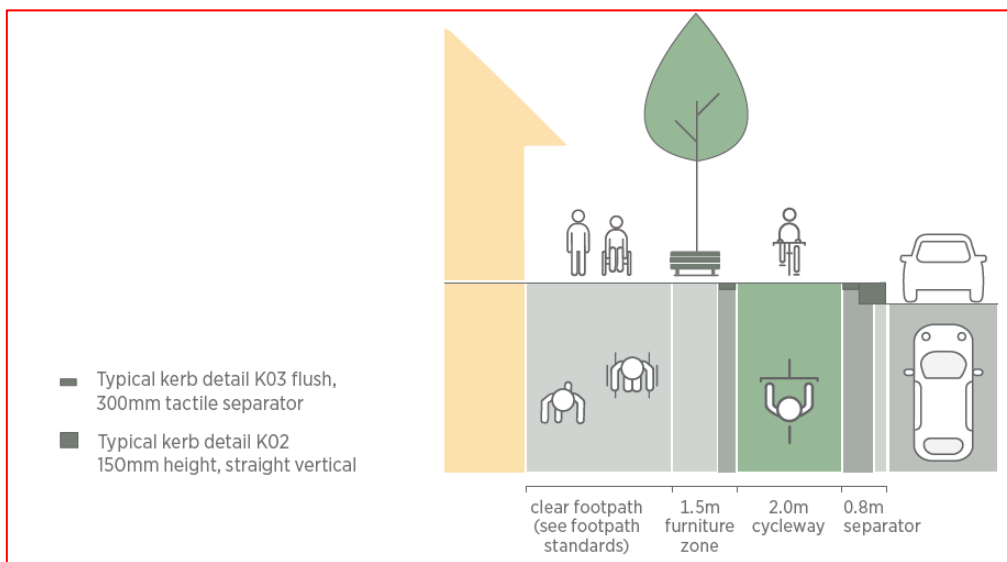

Figure 11: Approved design option 3

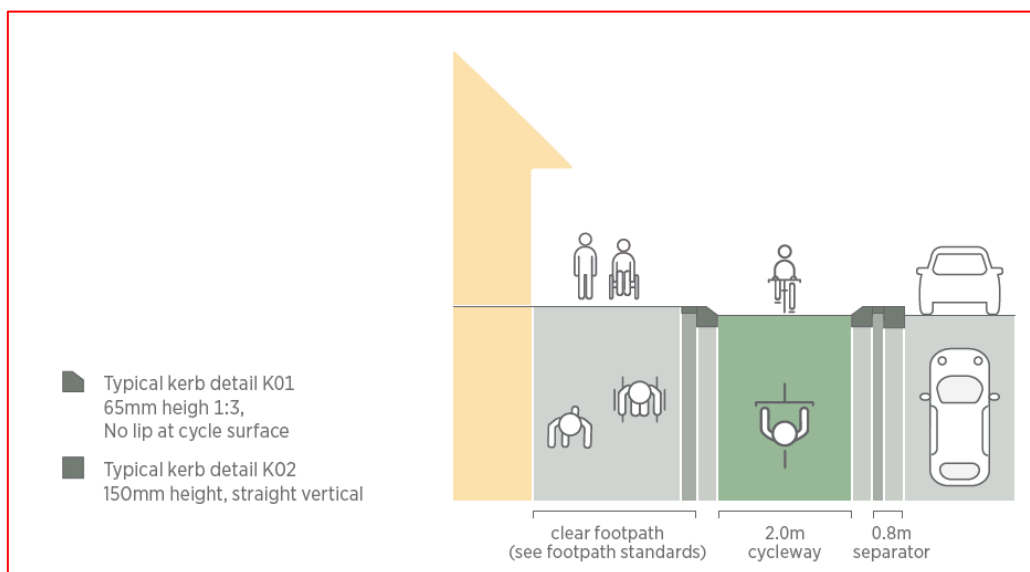

Figure 12: Approved design option 4

3.5.2.3 Mixed traffic streets

Mixed traffic streets should be designed to operate within the following criteria:

- Vehicle volumes –2,000 vehicles per day, or 200 per peak hour is the preferred maximum, but up to 3,000 per day or 300 per hour may be acceptable
- Vehicle speeds –less than 30 km/h (85th percentile speed)
- Where local network crosses arterial roads – minimum 50 opportunities to cross per hour
- Accessibility and safety afforded to people of all ages and abilities.

3.5.2.4 Pedestrian priority areas (cycling and pedestrians)

Special designs are required in high pedestrian activity areas.

3.5.2.5 Cycling with physical separation

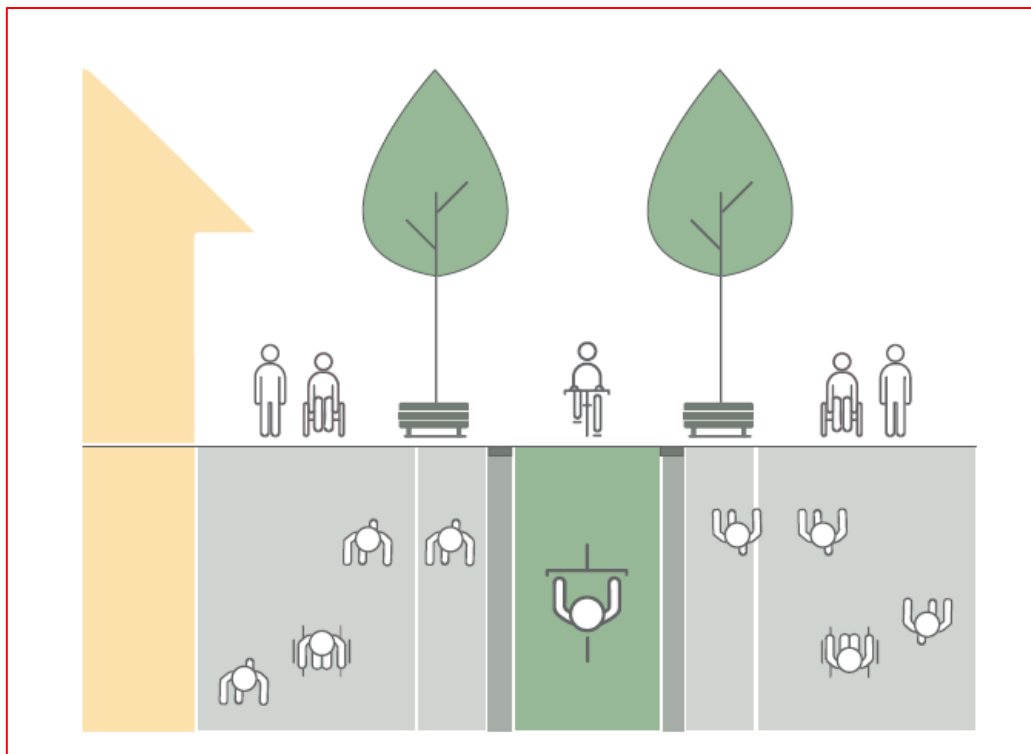

Figure 13: Cycleway through a pedestrian street or plaza

3.5.2.6 Interim facilities

There is often a need for Auckland Transport to respond to changes in the transport network or test layouts for long-term projects.

- These faster and more responsive options are broken down into two types; interim and temporary
- Interim design – design life of up to 15 years
- Temporary design – design life of up to 12 months.

3.5.2.7 Concrete island separators

The approved widths for interim facilities are shown below.

Table 25: Interim facility dimensions

Element	Approved width (Minimum)
Cycle lane width	2.0 m (1.5 m)
Cycle lane width (two way)	3.0 m (2.6 m)
Separator width (without parking)	0.6 m (0.4 m)
Separator width (next to parking)	0.8 m (0.6 m)

Clearance distances to be added to cycleway width:

- Kerbs higher than 70 mm: 0.2 m
- Vertical feature 150-500 mm high: 0.3 m
- Vertical feature >500 mm high: 0.5 m
- Clear from channel/catchpit, unless made suitable for cycling.

Precast concrete islands of 3 m to 5 m long, at least 70 mm high on the traffic side, and maximum 70 mm on cycleway side, should be used.

3.5.3 Other infrastructure

3.5.3.1 Buffered cycle lanes

The buffer consists of diagonal hatch markings between continuous edge lines.

Table 26: Width of buffered cycle lane

Element	Width Preferred (Minimum)
Cycle lane	2.0 m (1.5 m*)
Buffer (without parking)	0.6 m (0.4 m)
Buffer (next to parking)	1.0 m (0.7 m)
Buffer (speed limit >50 km/h)	1.2 m (1.0 m)

Note: Designers are required to use the preferred width. The minimum width is a guide for Departure where existing site constraints prevent achieving preferred width.

* Length of narrow cycle lane to be no more than acceptable distance with no cycle overtaking.

3.5.3.2 Cycle lanes

A basic cycle lane is located next to the kerb or to parking bays.

Table 27: Width of kerbside cycle lane

Preferred (Minimum)	
Cycle lane width	2.0 m (1.5 m)*

Note: Designers are required to use the Preferred width. The Minimum width is a guide for Departure where existing site constraints prevent achieving Preferred width.

*Length of narrow cycle lane to be no more than acceptable distance with no cycle overtaking

3.5.3.3 Cycle lanes between other traffic lanes

Cycle lanes positioned between traffic lanes should not be used on roads with design speeds greater than 50 km/h.

Table 28: Width of cycle lane between other lanes

Preferred (Minimum)	
Cycle lane width	2.0 m (1.5 m)*

3.5.3.4 Shared paths

A shared path is not an approved type and may only be used where numbers of cyclists and pedestrians are low enough to avoid frequent conflict.

Where combined cycle usage and pedestrian usage is between 75 and 150 per hour, a Departure from Standard is required, demonstrating that a shared path is safe and appropriate.

Where the function of the path requires a design cycle speed greater than 15 km/h, separation must be provided.

Table 29: Width of shared path

Element (Minimum)	Width Preferred
Shared path	4.0 m (3.0 m)
Kerb side buffer zone width (without parking)	0.6 m* (0.5 m)
Kerb side buffer zone width (with parking)	1.0 m* (0.7 m)

Note: Designers are required to use the Preferred width. The Minimum width is a guide for Departure where existing site constraints prevent achieving Preferred width.

*Length of narrow cycle lane to be no more than acceptable distance with no cycle overtaking

Path width should only be reduced where existing physical constraints cannot be removed, to not less than 2.5 m over a length not more than 15 m.

The gradients, colour, material and widths of the shared path must continue across driveways, to ensure a consistent, smooth cycle facility. In particular, there should be minimal changes in gradient on shared path across vehicle crossings.

3.5.4 Off road cycle paths

A path primarily for use by people on bikes, on an alignment away from the street network.

Width

Cycle paths will operate as two-way and are to be a minimum of 3 m. If shared use by people on foot is expected, the width should be increased to 4.0 m minimum.

As with any cycleway, it is necessary to provide clearance to path side hazards. Clearance distances to be added to cycleway width:

- Kerbs or drops higher/lower than 70 mm: 0.2 m
- Vertical feature 150-500 mm high: 0.3 m
- Vertical feature >500 mm high: 0.5 m
- Clear from channel/catchpit, unless made suitable for cycling.

Fencing and crime prevention through environmental design (CPTED)

- Where a cycle path crosses open public space, fencing may not be required adjacent to the path.
- Fencing must not create blind areas. Along or close to the path.
- Protective fencing may be needed next to drops or slopes.

Where use of public open space adjacent to a cycle path may lead to obstruction of the path, fencing may be needed to segregate users (e.g. along edge of playing fields).

- A cycle path between residential properties should have permeable style fencing erected on both sides of the path to a height of 1.8 m. Adjacent residential properties are encouraged to place habitable windows overlooking cycle paths. Permeable fencing can consist of pool style fencing, or similar, to allow full visibility and discourage graffiti.
- In areas where crime or issues of resident security are an issue, or where a cycle path in public open space is close to a commercial or residential boundary, alternative security fencing may be considered. Matt black as a colour is encouraged for permeable fencing types, as this can help the fence blend into the environment.
- An impermeable fence could be accepted as long as the fence can be lowered to a height of 1.2 m and good sightlines can be provided from adjacent buildings or activity.

If existing higher impermeable fencing bounds public open space, the cycle path should be kept away from the boundary if possible, or the length close to the fence should be open to surveillance from both ends.

Lighting

All areas with cycle or pedestrian traffic must be lit appropriately for the activity, All lighting should be consistent with Section 3.12: *Street lighting*.

3.5.5 Intersections

3.5.5.1 Cycleway intersections

Reduction of vehicle approach speed to 15 - 25 km/h may make conflicts safe and convenient.

3.5.5.2 Roundabouts

Single-lane mixed traffic (less than 150 bikes and vehicles per hour).

The roundabout should be designed to achieve low entry and circulating speeds not exceeding 30 km/h anywhere for cars.

Single-lane (high traffic volume)

Transition ramps should be provided to enable cyclists who wish to avoid traffic to leave the roadway before reaching each entry and cross with people on foot.

Multi-lane

Any multi-lane roundabout, whether signalised or not, should be provided with safe parallel cycle crossings at the roundabout, or offset if the deviation from a direct route is not excessive.

3.5.5.3 Signalised intersections

There are three signalised intersection types approved for use on streets suitable for cycling:

- Protected
- Signal prioritised
- Shared path corners.

Protected signalised intersection

- Approved for intersections of significant cycle routes (or future cycle routes)
- Should not be provided unless there are protected facilities on the receiving streets (or protected facilities are proposed)
- Space for a protected intersection should not reduce footpath widths below the standards outlined in the Auckland Transport *Engineering Design Code - Footpaths and public realm*
- Logical and consistent use of tactiles is vital to ensure blind and partially sighted pedestrians can navigate safely
- Tight corner radii for vehicles

- Design will use vertical or horizontal deflection to reduce cyclist speed and raise awareness of pedestrians and the crossing facilities
- The receiving island needs to be able to hold all pedestrians waiting to cross. This creates a shorter crossing distance, gives priority to pedestrians across the cycleway by use of a zebra, and removes cyclists from the signal control for left turn movements
- If there is insufficient room for pedestrians on the road side of the cycleway, the separator should be as narrow as possible, and the cycleway will come under the control of the signals (i.e. pedestrians wait and cross the cycleway and road in one phase)
- Pedestrian should have only one level change (i.e. depending on cycleway height, it is either raised to footpath level or the separator is dropped to road level).

Signal prioritised

- Safe, but may not be suitable for all ages and abilities
- Approved for retrofitting intersections in constrained environments
- Parallel (Toucan) crossings should be provided on all arms that lead to existing cycleways
- Hook turn boxes should be provided on routes that people on bikes are likely to use
- Safety of people on bikes is a built in with the signal control, but the efficiency of the intersection (delay) for riders is key. Long delays for riders will drive unsafe movements against the signals
- Detection technology can be used on key routes to lengthen the amount of green time for people on bikes. This can be used for bicycle or vehicular traffic
- With the short crossing times for people on bikes, reintroduction of bike green may be an option if conflicting phases do not have demand
- Low speed interaction of people on bikes and pedestrians can be controlled by the existing road user rules (e.g. riders with a green cycle signal, who are turning left across a green pedestrian signal, are required to give way to pedestrians)
- Use nearside small cycle lights to ensure people on bikes catch the signal.

Shared path corners

- Safe in many instances, but may have poor outcome for pedestrians
- Only to be applied by Departure
- Cannot be used on priority cycle routes or higher volume pedestrian/cycle areas
- Must have sufficient space for people on bike to be waiting out of the way of pedestrians
- Requires minimum 3 m wide shared crossing
- Design must indicate pedestrian priority
- Design must include clear, tactile, threshold between the cycleway and the “shared corner” space.

3.5.5.4 Unsignalised intersections

Where a cycleway crosses an unsignalised side road, a raised table is to be provided. Detail on construction of side road speed tables is contained in Section 3.7: *Traffic calming*.

3.5.5.5 Mid-block crossing

Where a signalised mid-block crossing provides for both people on bikes and pedestrians, separate signal hardware and detection for the two user groups should be provided. Cycle signals need to have red, yellow and green aspects. See also Austroads Guides *Cycling aspects*, Section 5.3.10.

Paired crossing (unsignalised or zebra)

A paired crossing is a cycle priority crossing located beside zebra crossing where all elements of the zebra crossing and the TCD rule 11.4(5) crossing must be used.

Figure 14 and Figure 15 show a shared path case only.

Design elements:

- The zebra crossing should be designed as standard width. The cycle crossing should be designed according to the movements (two-way or one-way movements) between 2 m to 3 m wide
- Zebra crossing markings, preferred on raised crossing table
- Belisha Beacon signs
- Give way marking on approach lanes
- Give way signs with supplementary “to pedestrians and cyclists” on approach lanes.

(Optional information signs –cycle symbol above “watch for traffic”)

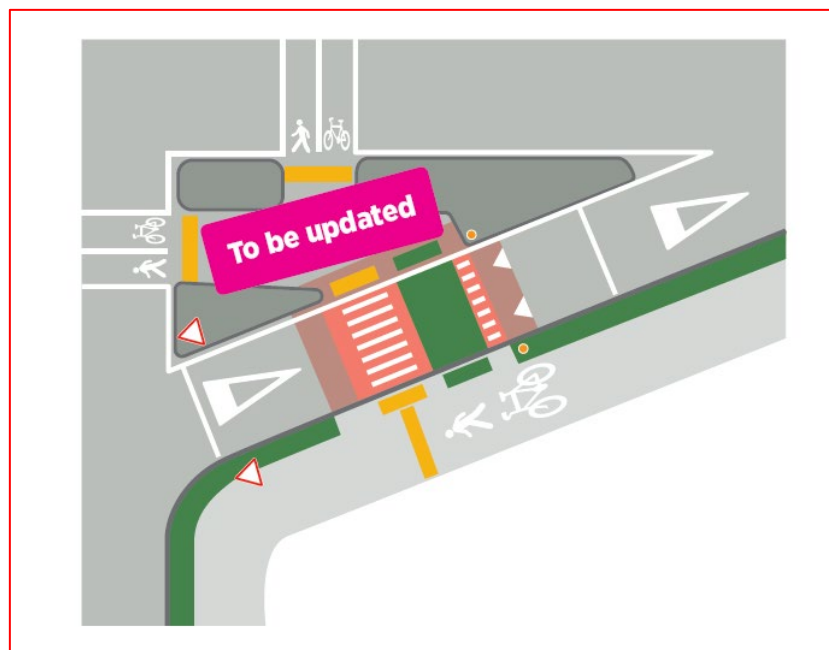

Figure 14: Paired crossing- one-way traffic

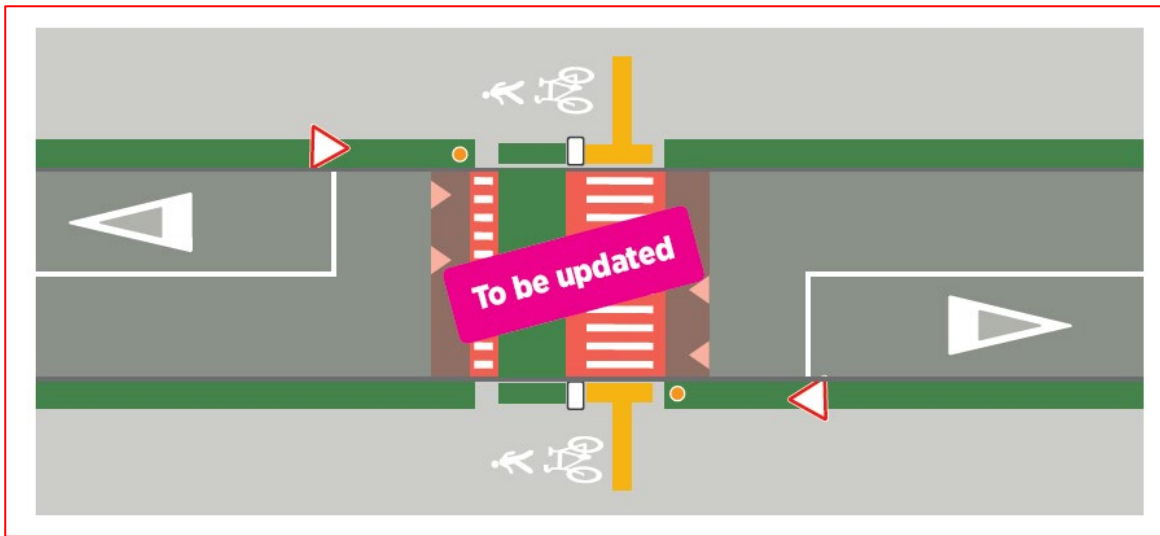

Figure 15: Paired crossing - two-way traffic

3.5.5.6 Vehicle crossings

In design terms, this means providing:

- A flush surface for the pedestrian and cyclist e.g. the cycleway, footpath etc is to have a flat vertical alignment and the driveway changes grade between road and property boundary
- A continuous surface, e.g. the cycleway, footpath etc. is to be seen as a single, uninterrupted surface, while the driveway material or colour is interrupted. (see below).

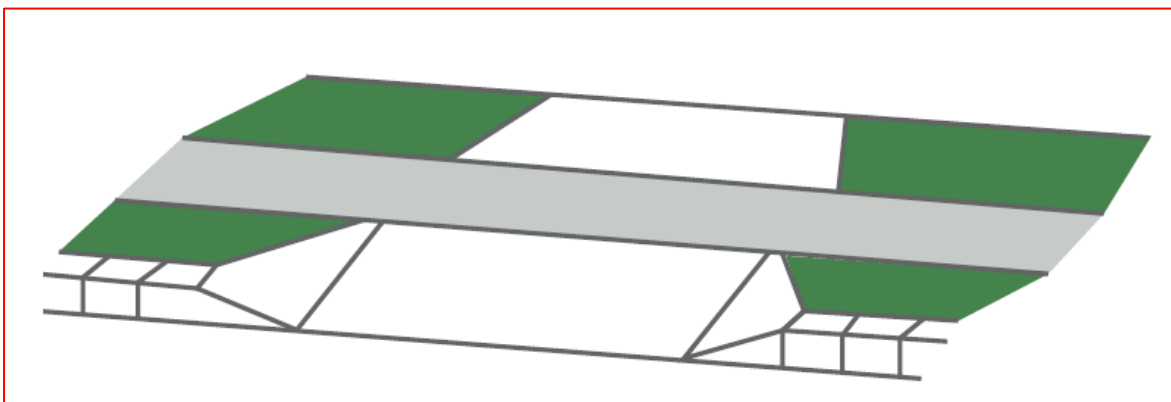

Figure 16: Surface treatment at vehicle crossing

Where cycle facilities cross commercial driveways “green dashed” markings should be used to raise awareness of people on bikes.

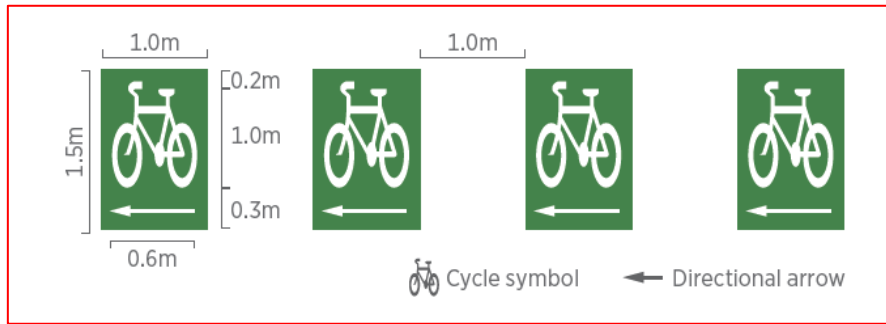

Figure 17: Bicycle marking layout

3.5.6 Kerbside activity

For collector or more quiet street typologies, a 0.8 m minimum buffer is required between any cycleway and the edge of parking. For arterial or busier collector street types 2 m buffer is required as a minimum.

- People on bikes have priority over people loading and unloading in a dedicated loading zone
- A minimum 1.2 m zone is required to allow deliveries to load a hand cart or similar prior to crossing the cycleway
- If loading is provided, the cycleway should be flush with the footpath or use 1:3 angled kerbs to allow easy passage for loading.

Bus stops

There are three types of treatments where cycleway pass through bus stops:

- Full island
- Partial island
- Boarder.

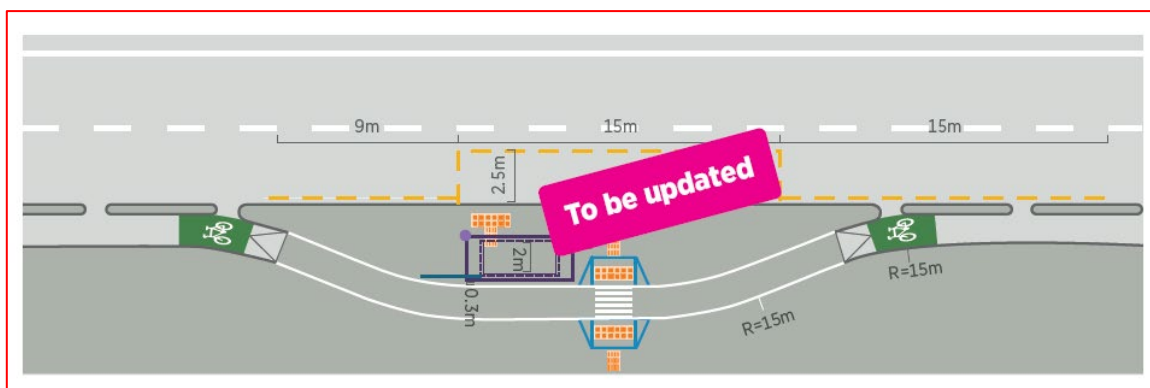

Physical barrier to prevent conflict at 'Blind' corner (eg railing, planters prevent conflict)

Red surfacing
Bus stop sign and flag

Figure 18: Full island bus stop

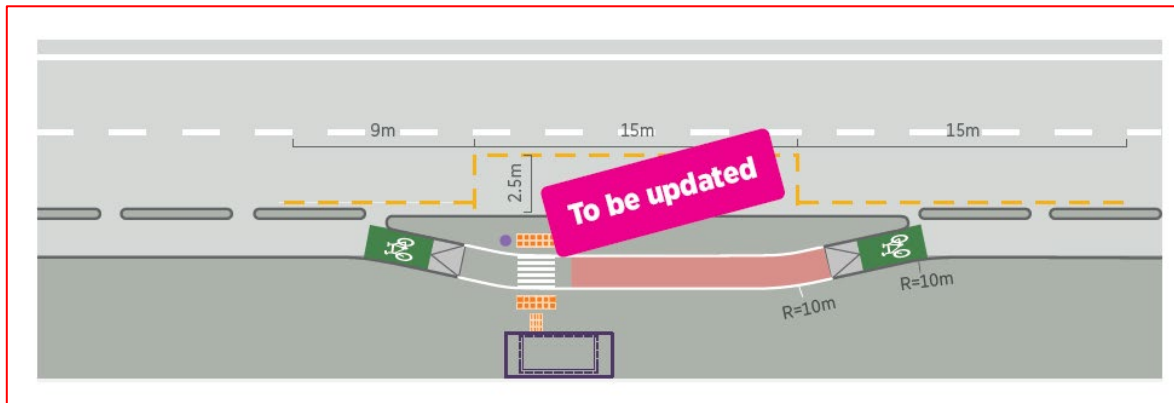

Figure 19: Partial island design

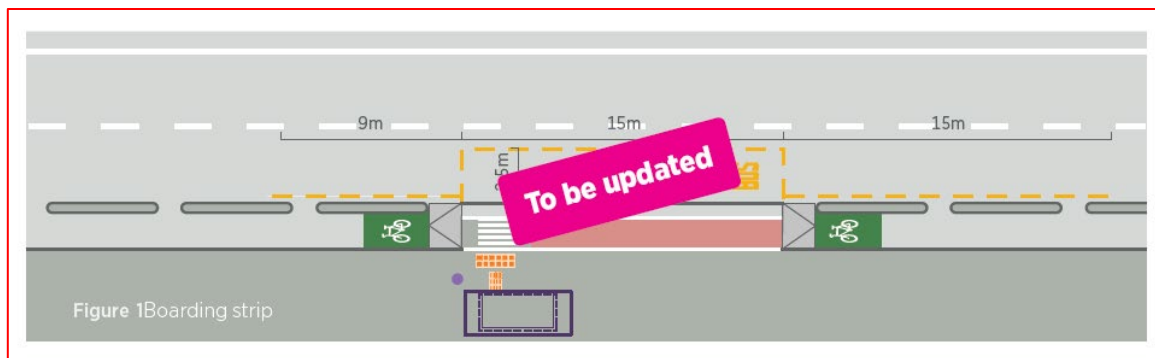

Figure 20: Boarding stop

3.5.7 General design

3.5.7.1 Design controls

Dynamic design parameters

- Reaction time is given a standard value of 2.5 sec which may be varied as a Departure in particular contexts.

Stopping distance and visibility

- Stopping distances are calculated using the formula:

$$S = \frac{V^2}{254 \times \left(f + \frac{G}{100}\right)} + \frac{R_T \times V}{3.6}$$

- Where:
 - S=stopping sight distance (m)
 - V =speed (km/h)
 - R_T = reaction time (sec)
 - f =coefficient of friction
 - G =grade (%,+for uphill, – for downhill)

Sight lines at curves

- Observer height is 1.4 m. Object height is generally 0 to allow observation of surface defects and layout of path ahead.
- For people on bikes approaching each other, an object height of 1.0 m can be used. Stopping Sight Distance is additive, if both users need to be able to stop at a point of conflict such as a narrow point or passing a hazard object on a path.

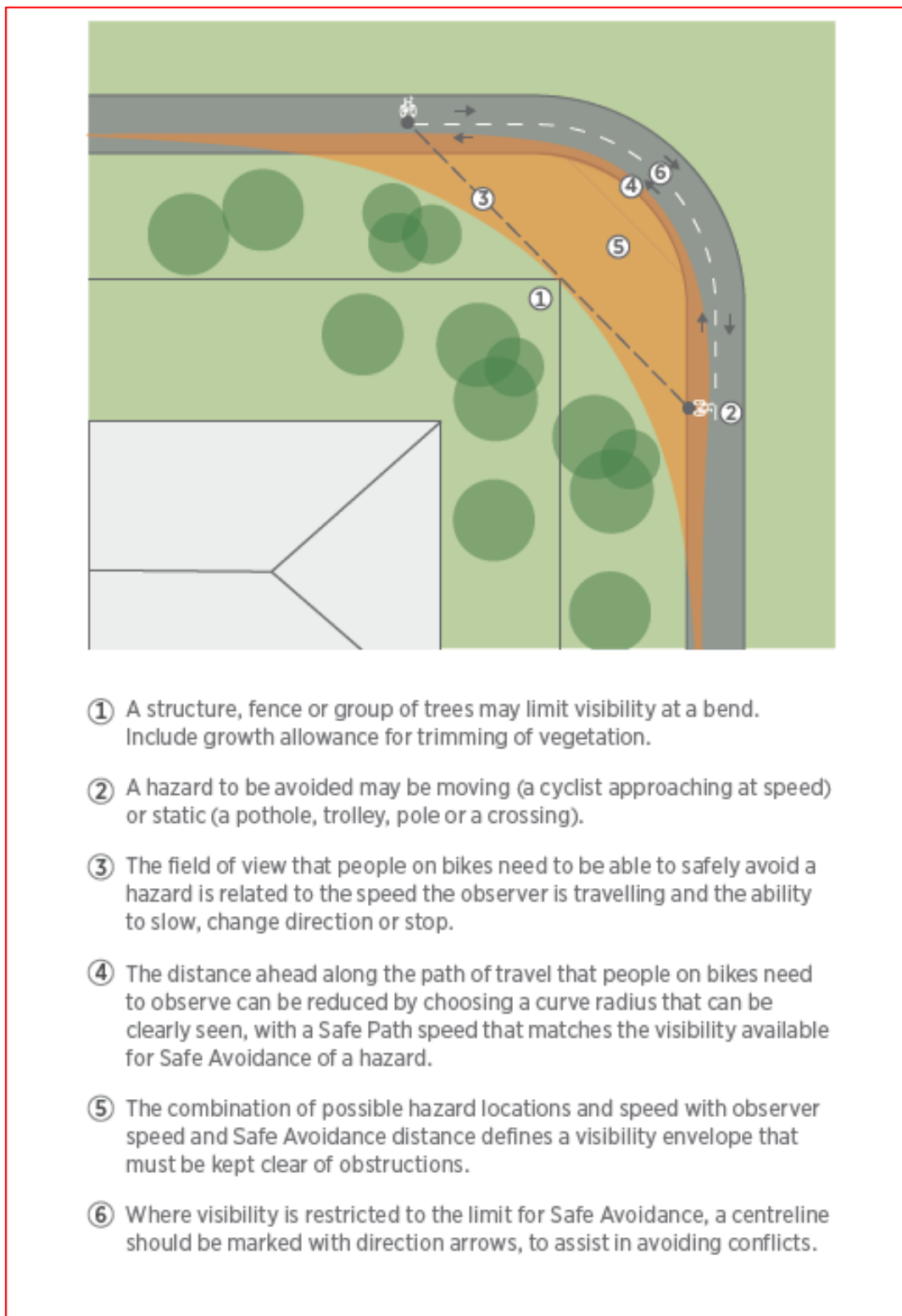
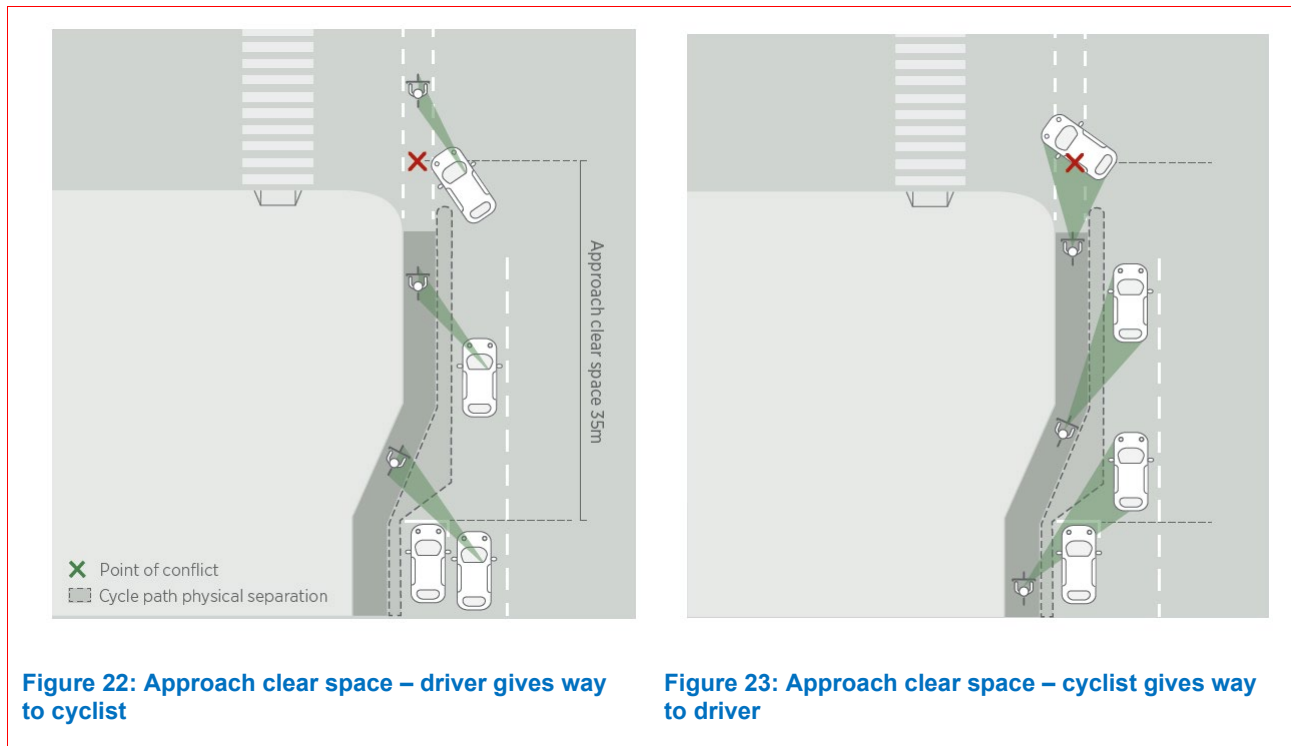

Figure 21: Lateral clearances on horizontal curves

Visibility at points of conflict

- The length of approach clear space is affected by cyclist speed and the turning speed of an approaching car.
- Cycle speed is taken as 25 km/h and car turning speed as 20 km/h.
- 3.0 seconds should be allowed for observation, decision and action, in addition to braking time.



3.5.7.2 Horizontal and vertical alignment

Horizontal alignment

Table 30: Horizontal curves

Travel speed (km/h)	Preferred minimum radius ¹
Stopping	2 m
10	4 m
15	7 m
20	10 m
25	18 m
30	25 m
40	50 m
50	94 m

1. Based on zero superelevation and friction factors of 0.31, 0.28, 0.25 and 0.21 for speeds of 20, 30, 40 and 50 km/h respectively.

Vertical alignment

- Wherever possible, a maximum grade of 3% should be provided.
- On some shared paths, where terrain dictates, designers may need to exceed the 5% grade recommended for short sections.

Landings/rest areas for pedestrian accessibility

- Where lengths of a route exceed the maximum gradients in Table 31 below, landings/rest areas should be provided.

Table 31: Gradients

Use	Max. gradient	Preferred max. length
Cycles only	3% (1:33)	No limit
	5% (1:20)	240 m (maximum)
	8.33% (1:12)	90 m (maximum)
	10%	30 m (maximum)
	12.5%	15 m
Combined cycle and pedestrian paths	3% (1:33)	No limit
	5% (1:20)	120 m (between landings)
	8.33% (1:12)	45 m (between landings)
	10%	9 m (between landings)
	12.5%	3 m (between landings)
Landings/rest areas	2%	3 m (minimum)*

Interpolation between values is permitted.

*3 m landing excludes a 2 m length of a transition curve at each end.

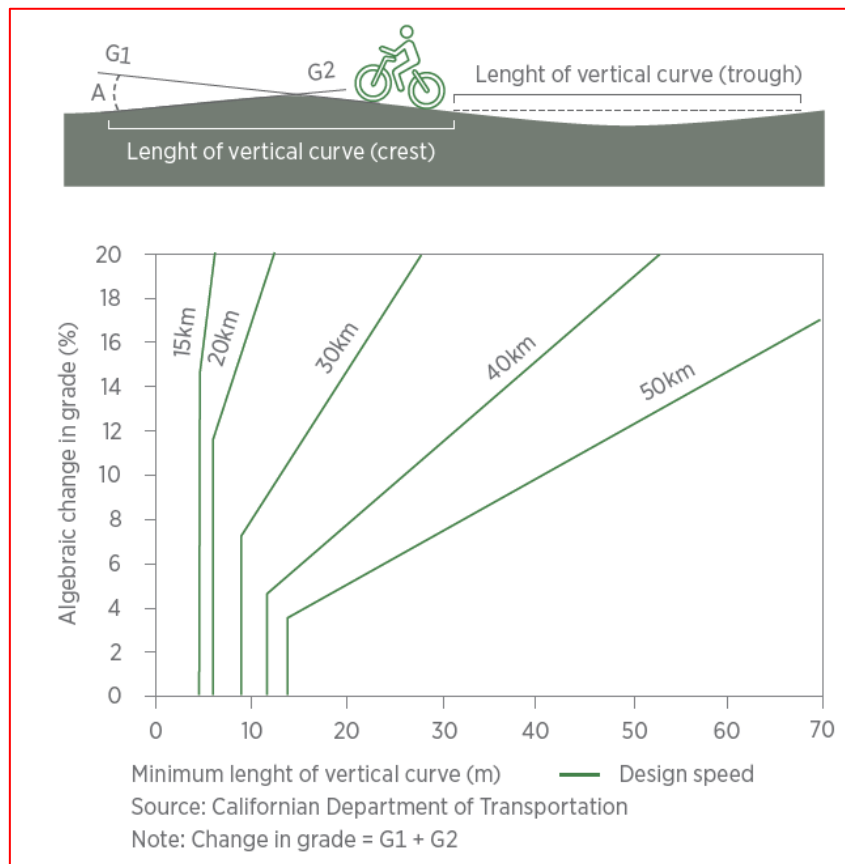

Figure 24: Gradient changes

Crossfall

- Preferred crossfall should generally be between 1% and 2%.

Path connections

- Where two paths intersect and join, the major (through) path shall be no steeper than 2% longitudinally for a minimum of 3.0 m length, centred about the intersection with the minor path.

3.5.7.3 Widths and clearances

Standard widths for approved cycleway types are given in Sections 3.5.2 and 3.5.3

The width of cycle lanes should be measured from the edge of the channel to the centre of the lane line. Measure from the kerb face only if there is no drainage channel (>5% crossfall) formed.

- If the cycle lane is between two traffic lanes, measure from the centre of one lane line to the centre of the other.
- If the cycleway is between two kerbs (without channel >5% crossfall), e.g. protected cycle lane, measure the width between the kerb faces.

File width for bikes

- The width for each file for cycling is the design bike envelope width, plus additions below.

Table 32: Thresholds for number of files

One-way path	
Bikes (peak hour)	Files Preferred (Minimum)
<150	2 (1)
150 - 750	2 (2)
>750	3 (2)
Two-way path	
<150	21 (2)
150 - 750	32 (21)
>750	4 (3)

Note:

Width of 2.6 m allows 2 opposing files (including two non-standard bikes) and for occasional opportunities for passing.

Path divided equally by centreline.

Two-way cycle path or shared path

- Allow 0.5 m between cycle envelopes for opposing cycle directions when high-speed cycling is expected.

Uphill cycle envelope

- For cycle paths in excess of 5% uphill grade, allow 1.5 m for cycle envelope width.

Shared path – other path users

- A minimum width of 1.5 m must be provided for other users, in addition to each file of people on bikes (below the threshold values for people on bikes and pedestrians).

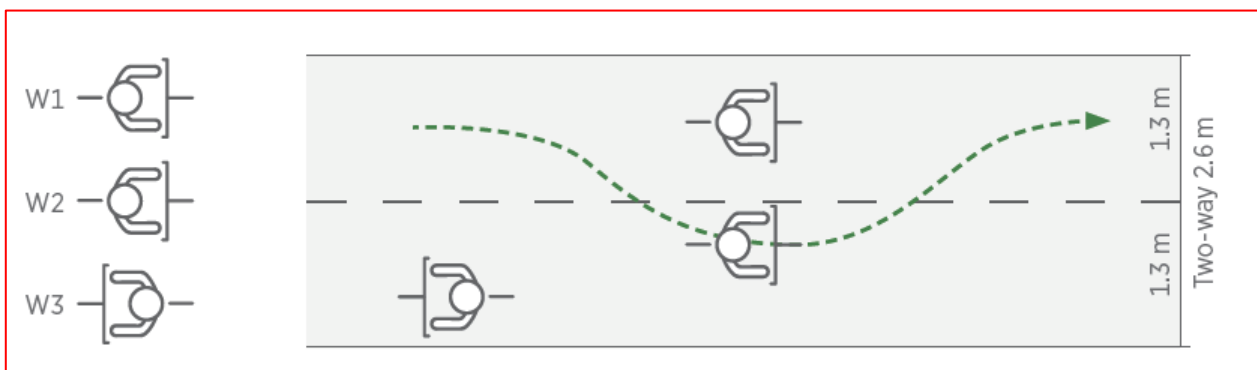

Figure 25: Example of file width considerations

Clearance width

- Objects at or close to the edge of a cycleway affect how close to the edge people can ride.
- These clearance widths should be measured from the width as defined above.

Curve widening

- The path swept by a cyclist through a curve widens with decreasing radius.

Table 33: Cycle envelope widening

Radius (m)	2	3	4	5	10	15	20	25	30
Widening (m)	1.0	0.7	0.6	0.5	0.3	0.2	0.2	0.1	0.1

Table 34: Edge clearances

Type of edge constraint	Clearance C Preferred (Minimum)
Vertical kerb 65 – 150 mm high	<ul style="list-style-type: none"> • C1 (from cycle envelope) 200 mm
Vertical feature with rubbing rail	<ul style="list-style-type: none"> • C2 (from cycle envelope) 300 mm
Kerbed edge –Vertical feature	<ul style="list-style-type: none"> • C3 (from face of kerb) 250 mm
Flush surface –Slope >1:10 or drop <0.5 m or vegetation	<ul style="list-style-type: none"> • C4 (from edge of path) 1000 mm (500 mm) (increase by width of trimming allowance for seasonal growth of vegetation)
Flush surface –Vertical feature	<ul style="list-style-type: none"> • C5 (from cycle envelope) 500 mm

Note:

Designers are required to use the Preferred width.

The Minimum width is a guide for Departure where existing site constraints prevent achieving Preferred width.

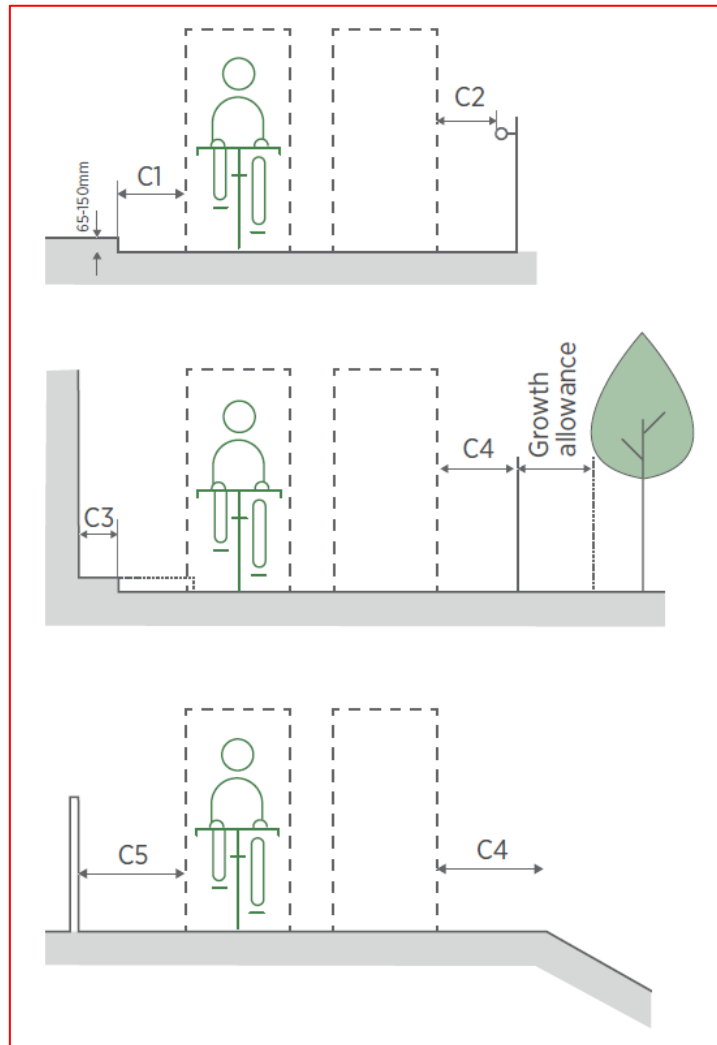

Figure 26: Edge clearance

3.5.7.4 Construction

Kerbs

- Fully-mountable kerbs 65 mm high and 200 mm wide should be used between separated cycleway and footpath where they are adjacent.

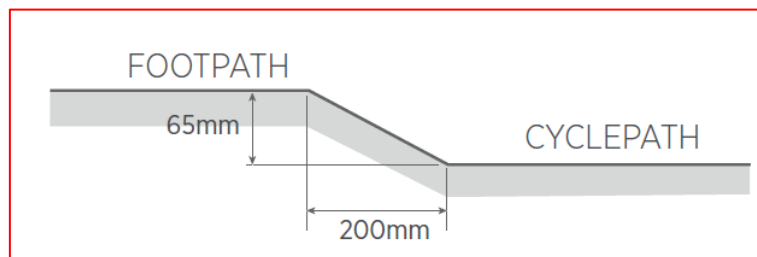

Figure 27: Kerb profile

Separators

- Precast concrete islands of 3 –5 m long, at least 70 mm high on the traffic side, and maximum 70 mm on cycleway side, should be used.

Approved surface

- Asphalt surfacing is the approved surface for cycleways and off-road paths.
- Concrete may be used on shared paths.
- Other surfaces, such as boardwalks, must provide suitable slip resistance and durability and will require Departure.

Utility covers

- Utility covers are preferred not to be within cycle facilities.

3.5.7.5 Drainage

See Section 3.11: *Road drainage*, for design and construction requirements.

Note that the design rainfall event for cycle path use is not the same as for vehicle traffic lanes:

- Where practicable, concrete channels shall be reduced to 3 - 5% crossfall
- Catchpits and grates may be placed adjacent to and flush with, but not within cycleways or cycle paths
- Kerb drainage blocks may be used
- Run-off from cycle facilities should be collected and treated separately from contaminated road run-off where practicable.

3.5.7.6 Signs and markings

Auckland Transport TDM SED CD0000 series provide requirements for various arrangements of cycle lane and path. Other specific signs and markings are shown in figures through this code.

Cycle lanes

- The use of pole signage should be minimised. Cycle lanes are legally authorised by the presence of M2-3 white cycle symbols marked in the lane, as per Schedule 2 of the Traffic Control Devices Rule (TCD Rule).
- The M2-3 cycle lane symbol is to be used as shown in Figure 28, with a symbol at the start of each block, a maximum spacing of 100 m between symbols and with symbols used more frequently in more complex traffic situations, e.g. at intersections or around parking or busy driveways.

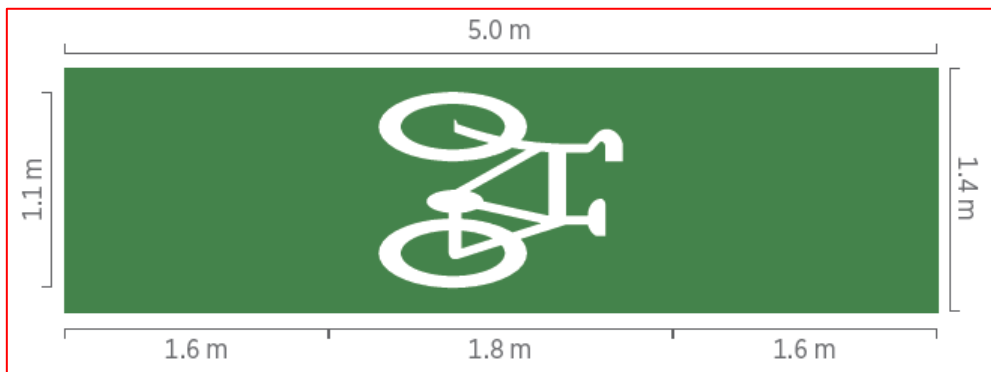

Figure 28: Cycle lane symbol

- A green surface should be applied to cycle lanes where drivers have to be reminded of the presence of people on bikes, colour for bus or cycle lanes is AS/NZS 2633 G26 “Apple green”.
- Coloured surfacing should not be applied over service covers within the lane, unless the service covers are very large, and omission could confuse the layout.

Cycle paths

- Generally, signs and markings should not be used on cycle paths and shared paths.
- The start and finish of a shared path must be indicated through the appropriate cycle symbol markings (true start or end of a path).
- Green surfacing may be used in protected cycle lanes or paths to warn footpath users of cyclist priority.
- At least one cycle symbol marking should be used with each section of green surfacing.

Wayfinding

- Wayfinding signs and/or marking are an important part of a cycle route and should be provided at all places where direction may change or be uncertain, and to confirm a route.
- Guidance is provided in Auckland Transport’s *Roads & Streets Wayfinding Guide*

3.5.7.7 Lighting

Lighting categories P3R and P4R shall not be used, and Category V lighting design shall include the cycle lane or path as traffic lanes. See also Section 3.12: *Street lighting*.

3.5.8 Ancillary features

Transition ramps

- The ramp gradient should not change by more than 8% along line of travel and 3% across line of travel.

Kerb ramps

- Kerb ramps as shown in Section 3.4: *Footpaths and the public realm*, and SED FP0006 may only be used along cycle paths where people on bikes are required to stop before crossing.
- The gradient of ramp plus the gradient of the road or channel should produce not more than 10% change of grade.

Tactile paving

- Where cycle paths cross traffic lanes alongside pedestrian crossing points and pedestrians could stray into the cycle crossing area, green TGS1 warning tiles should be used across the cycle path at the traffic lane edge and yellow across the footpath.

Obstructions

- All obstructions within cycle paths shall be coloured yellow with red reflective bands near the top or 1.4 m above ground, and at 1.0 m intervals on horizontal rails.
- Poles at the edge of a cycle path should be white, or contrasting with their background, with red reflective band or disc at 1.4 m above path level.

Bollards

- Bollards, staggered barriers and gates should only be used where unauthorised vehicles must be physically excluded.
- They should leave a gap of 1.6 m, leaving enough space for wheelchair and wide stroller access, but keeping narrow cars out. They should have a minimum height of 1.2 m.

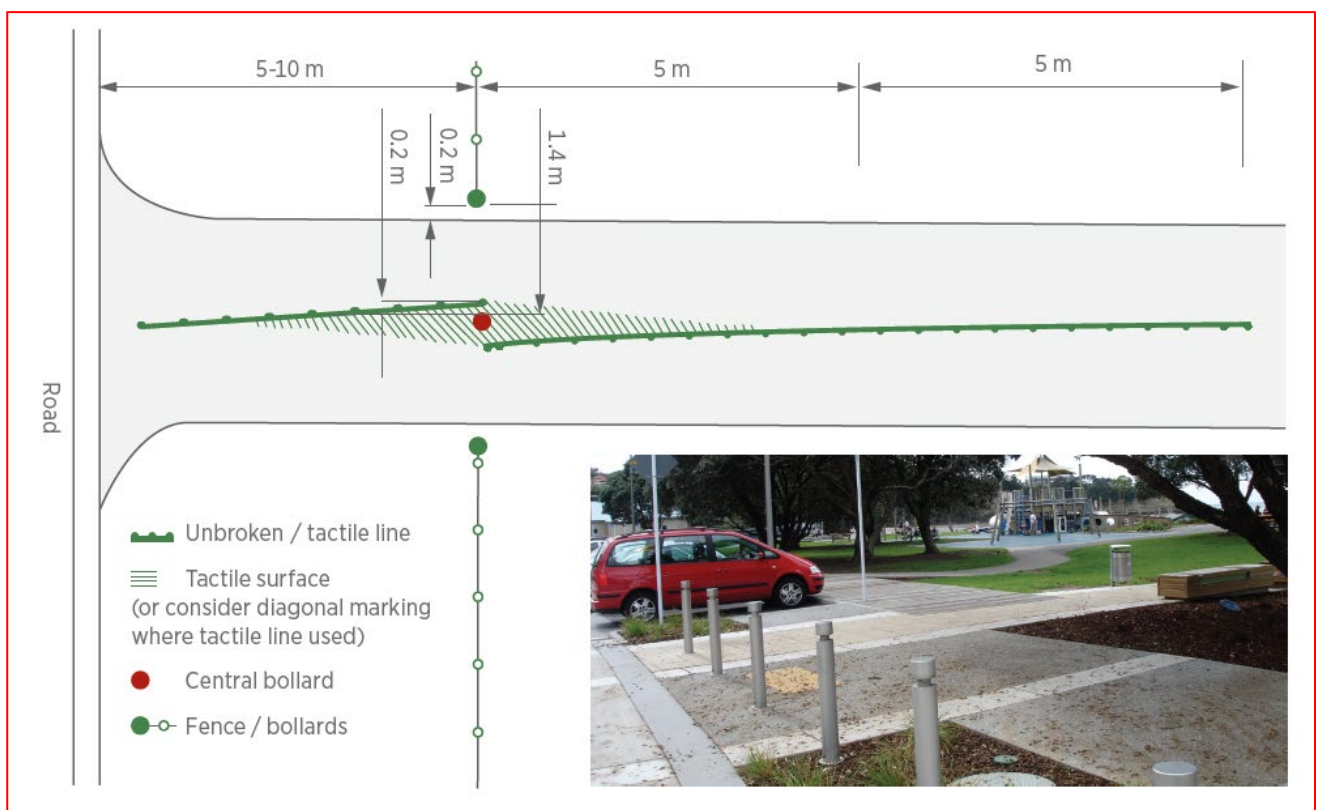

Figure 29: Path termination bollards

Stairs and wheeling ramp

- If access onto a bridge or underpass cannot be provided through a ramp with acceptable gradients and is only provided through stairs, provide a cycle wheeling ramp so that people on bikes can push their bicycles up or down the stairs.
- New construction:
 - Pitch 23° (1V:2.35H,43%)
 - Risers 120-180 mm. Tread at least 310 mm
 - Height of each flight at least 360 mm up to 2500 mm
 - Landings at least 1800 mm for each flight and preferably clear of through routes at top and bottom.
- Retrofit:
 - Where a wheeling ramp is added to an existing stair, pitch up to 32° (1V:1.6H,62%) may be accepted
 - Metal trough wheeling ramps may be used, but width, and the height and angle of the edge nearest to the steps must be sufficient to allow for wide tyres, and the angle at which a bike is held.

See Standard Engineering Details AT TDM ST0001 – ST0003.

3.5.9 Appendix A Cycle parking

Standard dimensions

- A standard adult bicycle is 1.8 m long, 1.25 m high, and 500– 700 mm wide.
- The wheels of the bicycle range between 0.3 and 0.7 m in diameter and tyres are 23–60 mm wide.

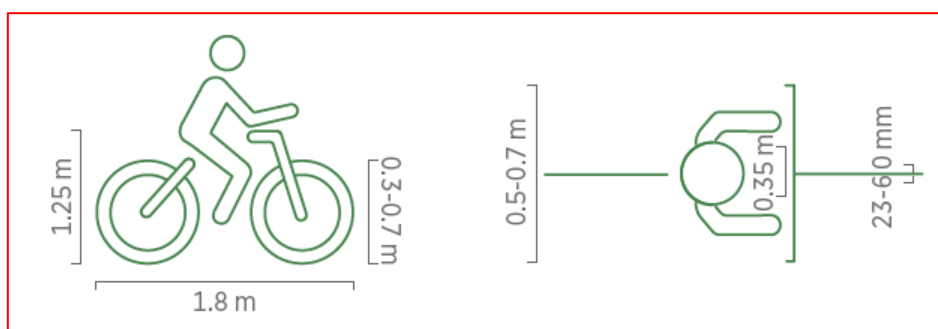

Figure 30: Basic bicycle dimensions

- A standard electric bicycle will be roughly the same dimensions.

Bicycle parking general principles

- Providing a mix of bicycle stands to cater for different user needs and shapes and sizes of bicycles. Figure 31 below shows an adaption of a bicycle stand for a child’s bicycle.

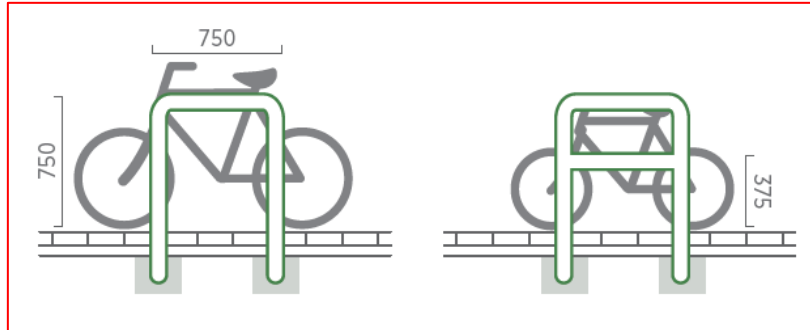

Figure 31: Adaption of a Sheffield stand for children’s bicycles

Types of bicycle parking

- a) Bicycle stands

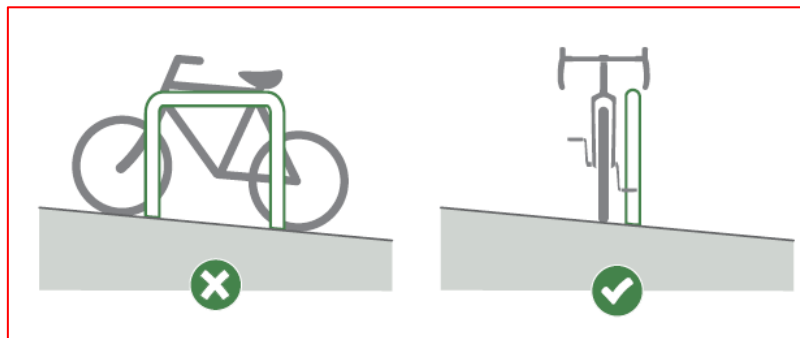

Figure 32: Bicycle stands alignment in relation to the slope

- b) Bicycle corrals. The most suitable type of bicycle stand for bicycle corrals is the Sheffield stand.

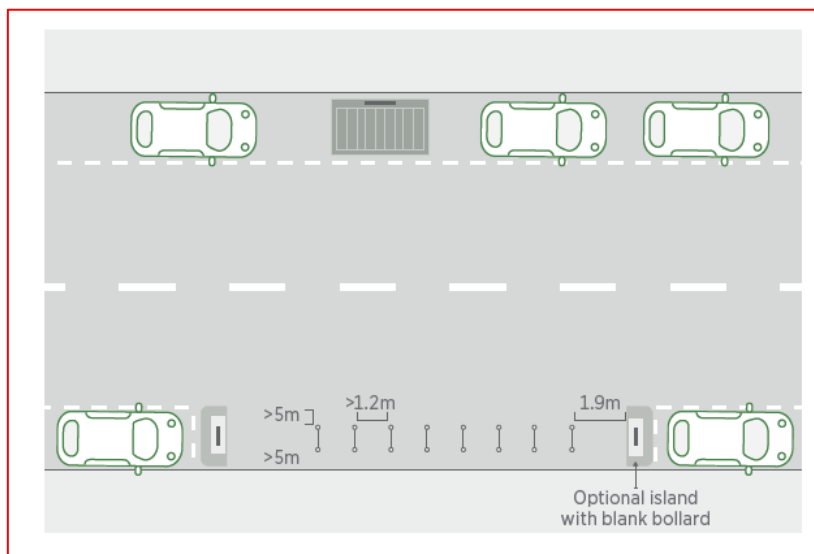

Figure 33: Indicative bicycle corral

- c) Bicycle enclosures. Secured parking shelters: The most suitable type of bicycle stand is the Sheffield stand.

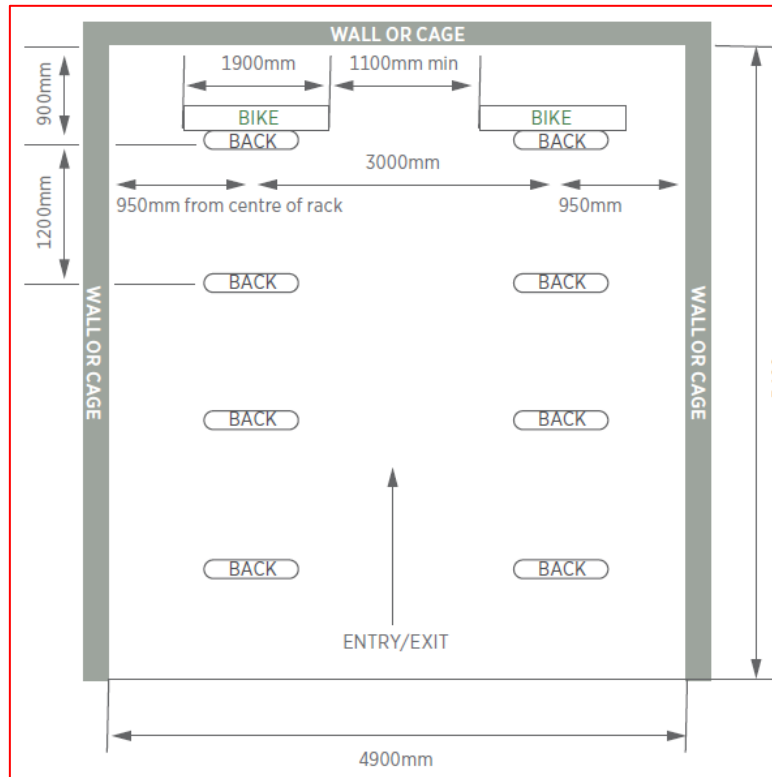

Figure 34: Long-term bicycle parking (for double sided stands, Sheffield only) layout for 16 cycles

Types of bicycle stands

- a) Sheffield stand

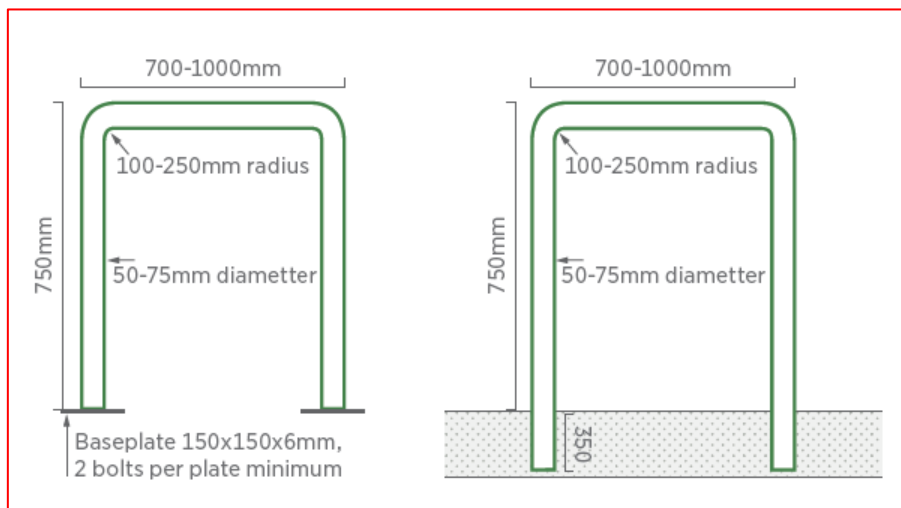

Figure 35: Sheffield bicycle stand dimensions. Left: surface mounted. Right: in ground

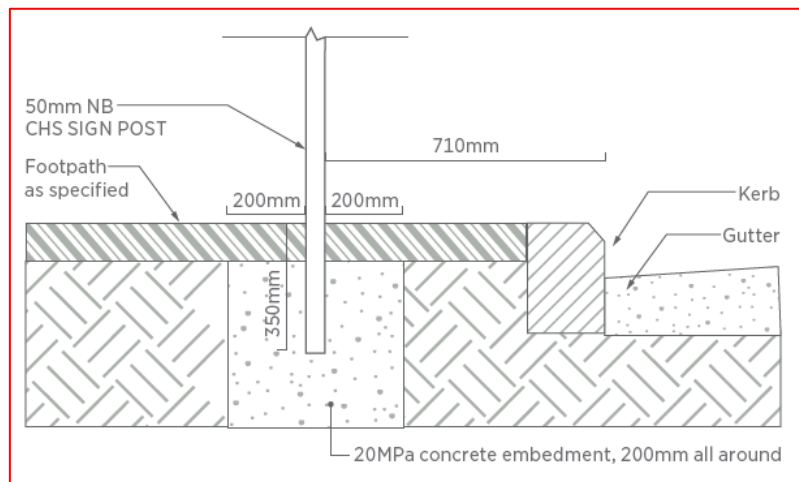

Figure 36: Required direct concrete embedment for a bicycle stand

b) Harrogate stand

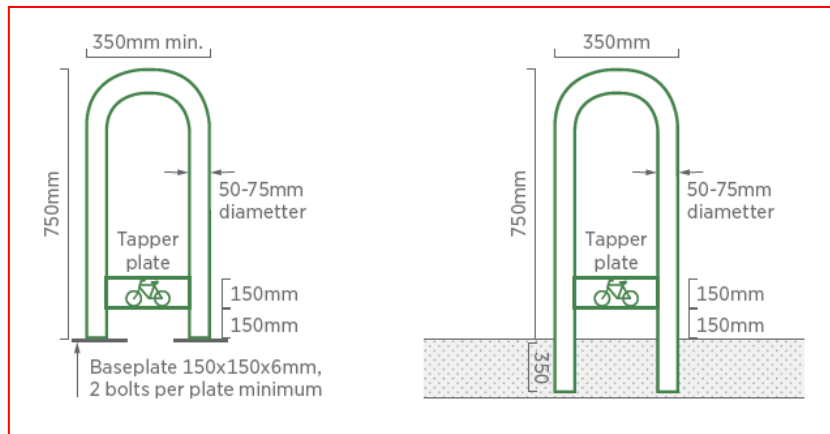

Figure 37: Harrogate bicycle stand dimensions. Left: surface mounted. Right: in ground

Bicycle parking placement

Table 35: Bicycle parking basic dimensions

	Desirable	Minimum
Bay width per bicycle	0.6 m	0.5 m
Spacing between stands	1.2 m	1 m
Wider bay (e.g. for young children)	0.65 – 0.8 m	
Bay length	2 m	1.8 m
Access aisle width	3 – 4 m	1.8 m
Total width –parking one side	5 – 6 m	3.6 m
Total width –parking on both sides	7 – 8 m	5.4 m

Clearances

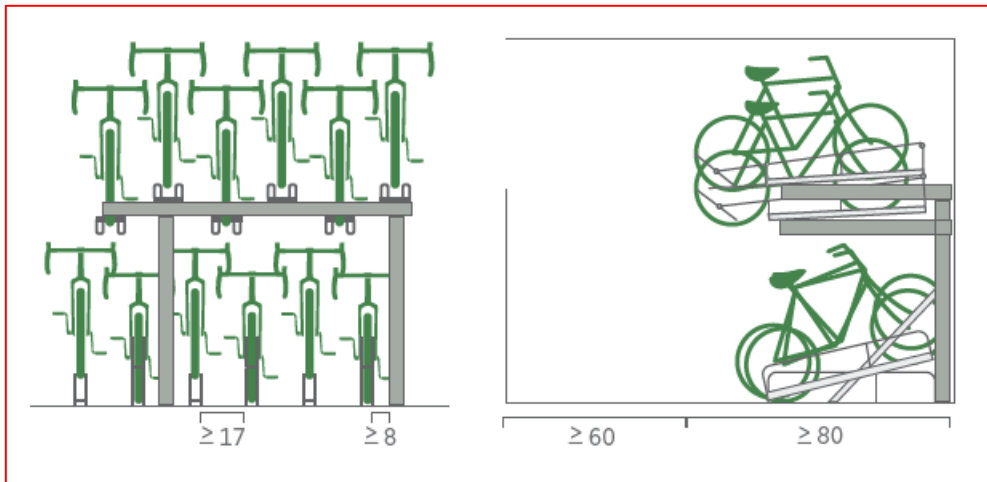

Figure 38: Indicative layout for bicycle parking

3.6 Public transport – Bus infrastructure

Well-designed bus infrastructure must:

- Provide easy access for buses through:
 - Accessible and safe walking routes to the bus stop
 - Consider all user groups who will have different needs
 - Making it easy and accessible to board and alight from the bus.
- Be consistent in design and provision, making it easy to identify and easy to use
- Help reduce bus travel times and improve bus service reliability through relation to road space
- Provide sufficient information on public transport services available from the stop
- Enhance the streetscape through its appearance
- Consider other road users, e.g. passing pedestrians and cyclists
- Be safe.

3.6.1 Design parameters

Infrastructure must be designed so that buses can:

- Pull into and out of a bus stop safely and efficiently
- Stop close and parallel to the kerb to pick up or set down passengers, so that all passengers can board or alight the bus in a safe, comfortable and easy manner.

3.6.1.1 Standard bus dimensions

While there are a variety of differing bus types operating in the Auckland region, they share many similar characteristics. The dimensions and layouts included in this Code of Practice have been based primarily based on a single-deck tag-axle bus that is 13.5 m long and 2.5 m wide (2.85 m – 2.9 m with mirrors) however designers need to consider other bus types that may be used on each bus route (e.g. double-deckers).



Figure 39: Typical 13.5 m AT Metro bus

Bus infrastructure in general should be designed to accommodate the above dimension of bus. Where other bus types will use bus infrastructure, designers must allow appropriate dimensional tolerances, or amend the bus stop design to suit the bus operating on the specific route. Alternative design vehicles for a particular route are to be approved only by AT Metro.

3.6.1.2 Double-decker buses

Double-decker buses are a maximum of 12.6 m in length and comparable in width to single-decker buses. The main additional design requirement for double-decker buses is allowance for their greater height. Vertical clearance of 4.3 m plus a minimum of 0.25 m additional clearance is required, with a relatively level lateral road surface gradient. Crossfall should generally be 3% or less, with smooth transition where it changes.



Figure 40: Typical 12.6 m AT Metro double-decker bus

Length

The standard Design Vehicle where buses will operate is the 12.6 m rigid; and the Check Vehicle is the 13.5 m rear-steer. CAD models for these two types are available from Auckland Transport's Design & Standards Team. In some areas, articulated buses that can reach 18.5 m are in use. If uncertain, please enquire with AT Metro if these vehicles will be in the area of any planned development.

Width:

Designers should currently consider a standard bus body width of up to 2.55 m. It is important to also note the total width of the bus increases to between 2.85 m – 2.93 m with mirrors added.

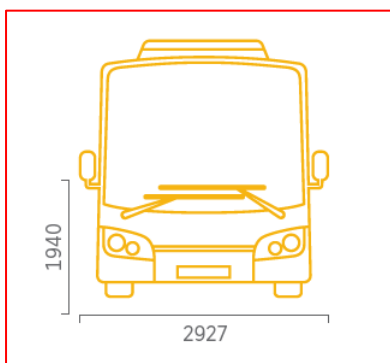

Figure 41: Standard bus body width

Height & general clearance

These requirements vary from the standard clearance envelopes in the Engineering Design Code: *Urban and rural roadway design*. Reduced clearances below may only be used where existing constraints require a Departure from Standard.

The legal maximum height of a bus in New Zealand is 4.3 m. This height PLUS safety margin must be considered when designing or maintaining bus infrastructure, to cater for double-decker vehicles.

The recommended minimum safe design height should therefore be 4.55 m to clear hard infrastructure, however for tree clearance and tree pruning purposes a recommendation is for trees to be trimmed at 4.75 m to allow for growth as well as wind and rain effects.

For bus routes that only use single deck buses, designers should note these buses in general have a maximum height of 3.35 m (Figure 42).

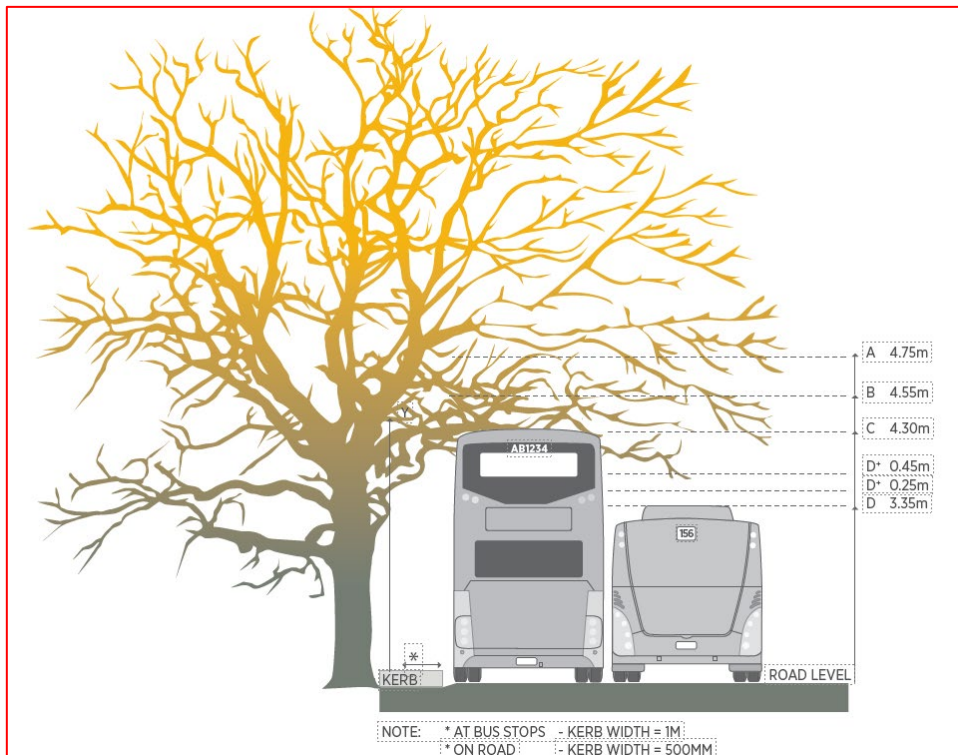

Figure 42: Clearance from soft obstacles (such as trees)

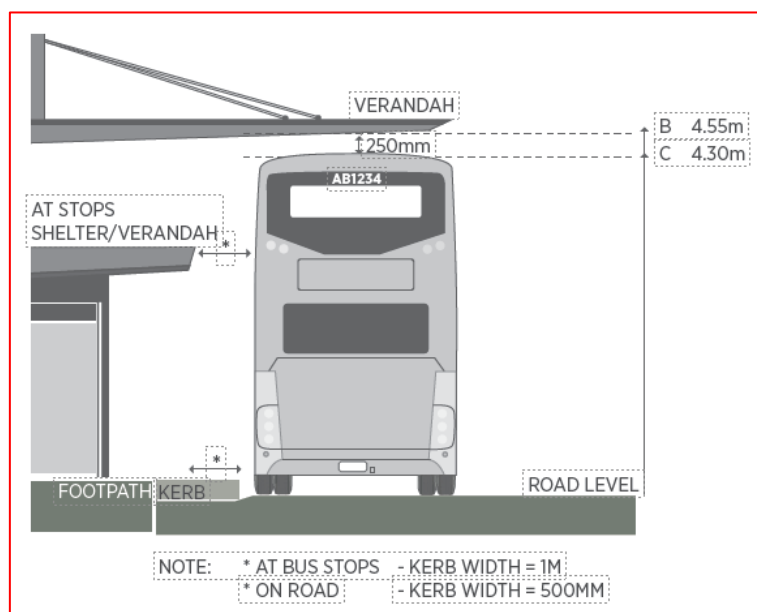

Figure 43: Clearance from hard obstacles (such as building canopies verandas and shelters)

Overhang and underside clearance

Front and rear bus overhangs must be considered for any infrastructure where height is a factor, e.g. speed limiting devices, catch pits and kerbside infrastructure. A standard 13.5 m bus has the following overhangs and clearances:

- Front 2.7 m
- Rear 3.5 m
- Underside clearance at axles 75 mm
- Underside body clearance when kneeling 160 mm.

Turning circle and sweep: clearance envelope

Buses have a significant tail swing when turning that must be considered in design, especially at (but not limited to) bus stops. Buses with a steering rear axle have a tighter minimum turn radius but a greater tail-swing. For this reason, all changes to the road corridor that affect a bus route (operational or repositioning routes) must be designed so that both types of bus can operate safely. For further information on the design and 'check' vehicles (non-steering and steering axle) to be used, refer to Section 3.3: *Urban and rural roadway design*. CAD files of the Design Vehicles are provided in the TDM: *Design tools*.

Front and rear overhang of all buses must be considered for clear width beyond kerb line where buses turn close to the kerb.

Bus stops must be designed to permit approach and departure without intrusion beyond the kerb, but also to remove risks of collision with fixed objects if a bus has to approach or depart more acutely.

The increased height of double decker buses means that any camber on the road surface will cause the upper corners of a decker to lean to a wider kinetic envelope when turning and to penetrate further across the kerb than a single deck bus given the same angle of approach into or departure from the stop. For this reason, every stop must maintain a clear space of 1000 mm behind the kerb face within the whole of the 15 m bus stop box, and in the 10 m of the lead-in space closest to the box.

If a stop design proposal cannot achieve this then the location must be reviewed in conjunction with AT Metro.

Bus door location

Buses normally have a two-door layout, with one at the front (entrance doorway) and one near the centre, usually used only as an exit. The entrance doorway is generally ahead of the front wheels and the exit doorway between the front and rear wheels.

Continuous hard paving and kerb is required so that both front and centre doors will always align with a safe boarding/alighting platform

3.6.1.3 Design for bus drivers

Consistent experience

Bus drivers ideally need to have a consistent experience. Therefore, bus infrastructure design must consider existing layouts that are familiar to bus drivers. The design must not require bus drivers to perform unfamiliar or difficult manoeuvres.

To help facilitate driver awareness, the implementation of elements, such as raised kerbs at bus stops, should preferably be done on a corridor basis, rather than ad hoc. Although there are still benefits to formatting individual stops such as hospitals for improved accessibility.

Legibility

Any stop and its layout should be visible to approaching bus drivers so that they can signal and manoeuvre correctly to stop parallel to the kerb at the head (front) of the stop.

Visibility

The stop should be positioned so that a departing bus can be seen by approaching drivers and that the bus driver can see all traffic approaching, including cyclists and turning traffic.

Gap acceptance

Sight distance should be sufficient for a bus driver to identify a safe gap to pull out.

3.6.1.4 Design for bus users

Whole of journey

The bus is only part of the system and the whole journey – from door to door – must be accessible and attractive to passengers

Type of passengers

When designing facilities for bus passengers, consideration must be given for the requirements of the following groups:

- Impaired mobility, vision, hearing or cognitive skills (vulnerable road users)
- Passengers with young children, pushchairs and prams
- Passengers with large or heavy luggage or shopping.

3.6.1.5 Design for boarding

Number of boardings

The number of passengers using a bus stop could influence its design. AT Metro holds data on patronage at all existing official stops. For stops on future bus routes or where services are changing, forecast patronage must be discussed with AT Metro.

Step height and horizontal gap

The bus stop layout should allow the bus to stop parallel to, and as close to the kerb as possible to make it easy and safe for passengers to get onto and off the bus. The critical dimensions to consider are:

- The vertical gap, or step height, from the kerb to the bus floor
- The horizontal gap from the kerb edge to the side of the bus
- The design should aim to minimise these two distances.

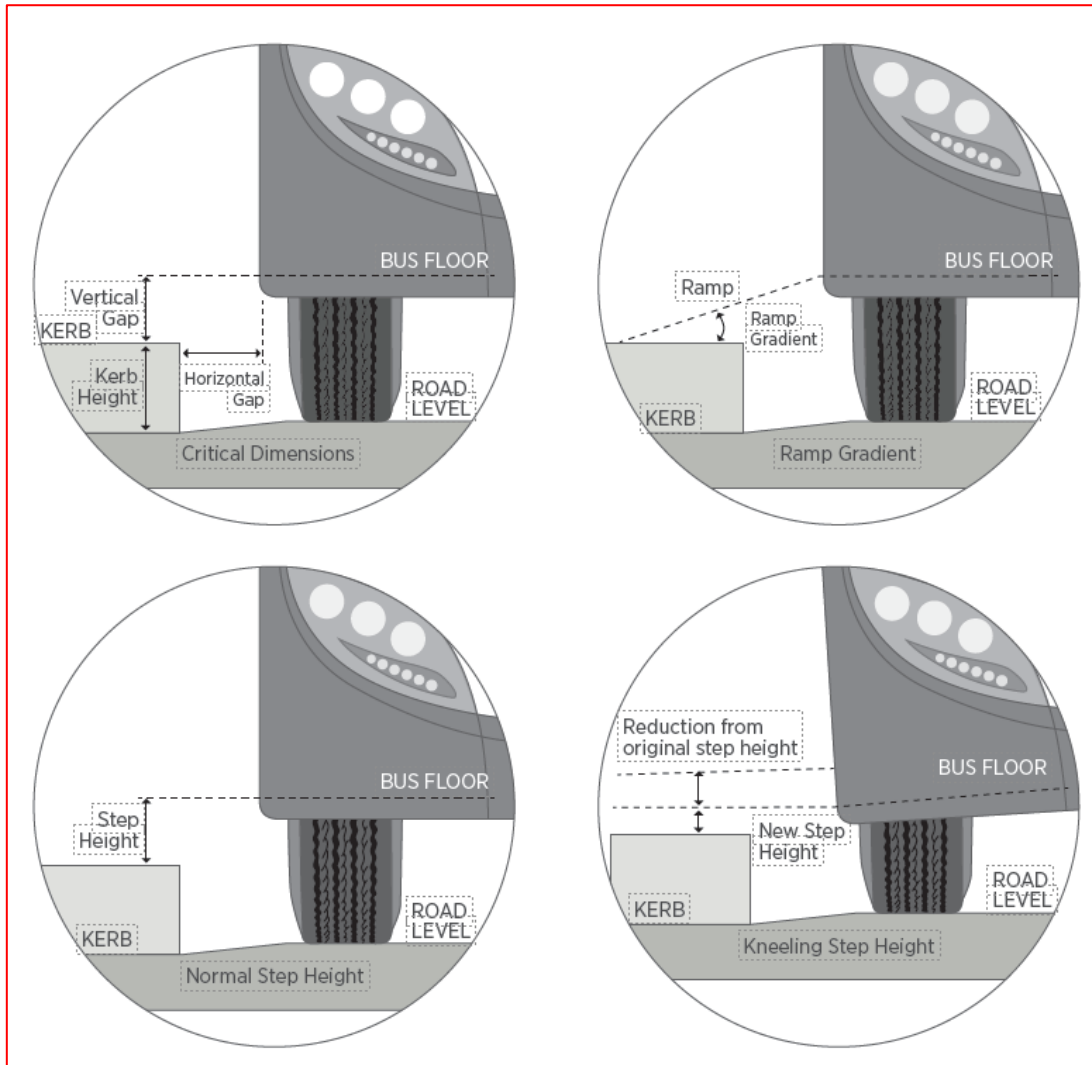

Figure 44: Horizontal gaps, ramp gradient and step height

Universal design

The design of bus stops is an essential complement to the requirements for accessible land public transport, as envisaged in the NZ Disability Strategy and the Human Rights Inquiry. For further information on accessible design refer to NZS 4121:2001 *Design for access and mobility*, for key information.

Continuous hard surface

In order that all customers can board and alight safely, a hard, non-slip surface must be provided alongside where the bus will stop. This is to ensure that customers stepping from footpath to bus or vice versa have a firm footing; and so that the wheelchair ramp can be deployed safely when required for wheelchair users.

The hard surface must extend as a minimum for 9 m measured from the head of the stop box. It must have a continuous kerb at minimum 150 mm height (ideally 160 mm), with no drops for crossings of any kind.

Where a bus stop is required at a location without continuous footpath, the hard-stand must be formed as a short section of footpath with kerb, at least 10 m long and a minimum of 2 m wide for the whole of the 10 m length.

Low-floor buses

Most urban buses in Auckland are of a 'super low floor' type.

The benefits of low-floor bus construction are realised when the floor height matches closely the kerb height at bus stops, which is assisted by 'kneeling' suspension systems. By matching the kerb and bus door heights, all customers are provided with the safest, easiest and most comfortable boarding and alighting environment, and those with mobility difficulties are enabled to make use of bus services much more independently. Efficient boarding and alighting also reduces stop dwell times for bus services.

Kerb heights at bus stops therefore become very significant to both customers and to operators. In order to minimise the height differential between kerb and bus, a minimum kerb height of 160 mm is recommended and must be provided at every stop where the kerb is broken out and replaced or the kerb line extended by any project. For accessible kerb advice (e.g. Kassel kerb), see Section 3.6.7.2: *Kerb height*. Where Kassel kerbs are used a kerb height of 160 mm will be achieved.

Access ramps

The requirements for new urban buses are that wheelchairs, prams, etc., load at the front. Wheelchair ramps of 800 mm wide and 800 mm long are fitted to all new urban buses.

To deploy the ramp correctly a minimum kerb height of 150 mm (ideally 160 mm) and a sealed area clear of obstructions must be provided.

Designing for ramps

Where kerb and bus door heights can be brought to within 40 mm and the bus docked close and parallel to the kerb, it should be possible for most users including those using wheelchairs to board and/or alight without the use of the integrated ramp.

Where the kerb height and bus door height cannot be synchronised to that extent, it must be possible to deploy the ramp from the front door with the bus docked close and parallel alongside the kerb. Drivers must not be obliged to position the bus differently in order to deploy the ramp, as non-ramp users must also be able to board and alight with the bus in the same position. Consistency of experience is very important.

Wheelchairs must be able to manoeuvre on to and off the bottom of the ramp safely, conforming to the minimum space requirements for wheelchairs set out in NZS 4121:2001.²⁰

3.6.1.6 Design for accessibility

Pedestrian movement

The bus stop design should allow for the safe and easy movement of pedestrians along the side of the road where the bus stop is located, as well as crossing the road, particularly for those transferring between services.

Footpath width

Bus stops should be sited where there must have footpaths that are wide enough, so that waiting bus passengers do not obstruct passing pedestrians. This is especially important for bus stops alongside retail activity. When building new streets sufficient space must be allocated between kerb and boundary.

If developing within existing streets and the existing footpath is too narrow, consider locating the bus stop where the footpath can be widened, without compromising other location criteria; or adjusting the site boundary to give more space to the street. The use of bus boarders should also be considered (for bus boarders, see Section 3.6.4: *Bus stop layout*).

3.6.2 Movement or upgrading of bus stops

Existing routes

Any development or project which requires an existing bus stop to be moved, or which results in a change to the expected usage of a stop, shall be discussed with AT Metro.

The legal requirements for moving a stop may affect the project or its timescale; and private developers must be made aware of their responsibility for preparing resolution reports and plans for their own projects where the road corridor is affected.

New development

Once routes are agreed with AT Metro, stops shall be provided in accordance with these guidelines. In some cases, where services are not able to start immediately, installation of shelters and other elements may be deferred, subject to agreement with AT Metro.

²⁰ *Design for access and mobility*

3.6.3 Bus stop location

This section provides a framework for the placement of new bus stops and for the review of existing stops. It indicates where they can be placed in relation to other road and environment features.

3.6.3.1 Decisions about bus stop location

Triggers

Decisions about the location of bus stops are usually triggered when:

- New developments are planned
- Changes are made to existing bus services
- New bus routes are being planned
- Transport authorities review bus stops.

Reviews

AT Metro may review the location of existing bus stops:

- As part of future bus route planning or bus priority schemes following routine audits of accessibility or safety
- Where buses experience delay in re-joining the traffic stream
- Where there are too many bus stops along a route, increasing the proportion of stop time to travel time.

On review, new optimal bus stop placement may be achieved by:

- Moving existing bus stops to more appropriate locations
- Providing additional bus stops
- Consolidating existing bus stops.

Consultation

The decision on the location of every new or relocated bus stop rests with AT Metro, subject to statutory processes.

- Auckland Transport requires that consultation should be undertaken with Local Boards, the Police and owners and occupiers of adjacent properties.
- AT Metro will undertake consultation with bus operators.

3.6.3.2 Bus stop spacing

For buses to offer a real alternative to private cars, they must be within a comfortable walking distance from people's origins and destinations.

Spacing for bus stops must consider the street's place and movement functions and passengers demand for use of the stop. Bus journey times are affected by the number of stops on a route. Therefore, to achieve

optimal spacing, a careful balance must be achieved between the passenger need and the bus operator's requirement to run an efficient service.

Table 36: Bus stop spacing guidance

Location	Recommended spacing	Reason
Urban area (outside main centres)	400 m (or 3 per km)	Equates to generally acceptable 5-minute walking distance.
Main centre (e.g. CBD)	150 m – 400 m	More demand in higher density areas; pedestrian delays at controlled crossings.

Influencing factors

The recommended spacing may be varied for other factors:

Population density	<ul style="list-style-type: none"> In densely populated areas, stops should be spaced closer than 400 m. In higher density residential areas, stop spacing may be 150–400 m. In areas with low densities, e.g. rural areas, stop spacing may be increased to one every 800 m or more. The appropriate spacing should ultimately be determined by demand generators, identified needs, safe locations for buses to stop and for people to cross the road.
Walking network	<ul style="list-style-type: none"> The layout of streets and walkways may limit access to stops. All properties in new development areas, and as many as practicable in existing areas, should be within 500 m of a bus stop.
Frontage access	<ul style="list-style-type: none"> Where land use along the bus route has few access points for pedestrians, specific trip generators and the walking network accessible to the route will be more significant than spacing.
Passenger characteristics	<ul style="list-style-type: none"> If passengers are likely to be elderly, carrying bags, or have their mobility impaired in any way, bus stops may have to be spaced more closely.
Topography	<ul style="list-style-type: none"> In hilly or very steep areas, bus stop spacing may have to be closer together.
Trip generators	<ul style="list-style-type: none"> A more frequent stopping pattern is appropriate in major CBD or town centres that are major trip generators, or to serve key community facilities.
Bus service level	<ul style="list-style-type: none"> The longer the time between buses arriving, the shorter the distance to the bus stop that will attract passengers. Conversely, areas with a high frequency of services will allow passengers to 'turn up and go', attracting passengers from a wider catchment, so that bus stops may be placed further apart.

3.6.3.3 Bus stops for school bus routes

Provision of access to bus services on routes operated only by school buses must follow the same principles as on other routes. Different design standards may apply to the layout of bus stops, as they will generally be required only at certain periods of the day, and only during Mondays to Fridays. The primary design difference plus time use difference is to enable the space required by buses to approach, stop and depart safely and efficiently to be reserved for their use only at the appropriate time, and thereby to allow other uses of the space at other times.

Influencing factors

Location of stops at or near schools will be influenced by the age group of the children expected to use the service; by any constraints on the routing of the school bus service; by other land uses/trip generators in the vicinity from which customers will use the stop. If a school stop is not required outside school bus hours, its hours of operation should be limited to an appropriate period.

Provision of shelter at school stops can be demanded strongly by the community and is desirable. Peak waiting demand is very compressed, requiring potentially larger shelters than the total patronage might otherwise suggest.

Stops served only by school buses to collect children in the mornings or drop them home in the evenings should also be designed to be effective only at limited hours. A bus shelter is desirable for pick-up stops.

3.6.3.4 Bus stop capacity

The bus stop capacity (space for buses) must suit the number of buses servicing the bus stop at any one time. Poor capacity bus stops may force buses to queue on the road, causing traffic congestion and reducing accessibility for passengers. Bus stop capacity is typically an issue where bus stops serve multiple frequent service routes in urban centres. This includes bus stops along key transport corridors and those at main destinations such as the CBD, retail or business centres, town centres, hospitals, universities, and at Interchanges.

The capacity of a bus stop is usually expressed by the number of buses that can enter the stop area within a specified time, usually an hour.

A bus stop's capacity is determined by the length of time a bus spends occupying the bus stop (dwell time) and the number of buses that could pass through the stop within an hour. To determine the required capacity, assume a minimum of 20–30 second dwell time for each bus (note in certain locations this can be much higher). Determining the appropriate capacity may require detailed analysis of the particular stop, especially at major destinations.

3.6.3.5 Bus stop placement

The optimum placement of bus stops depends on a wide range of factors that have to be balanced, as outlined below.

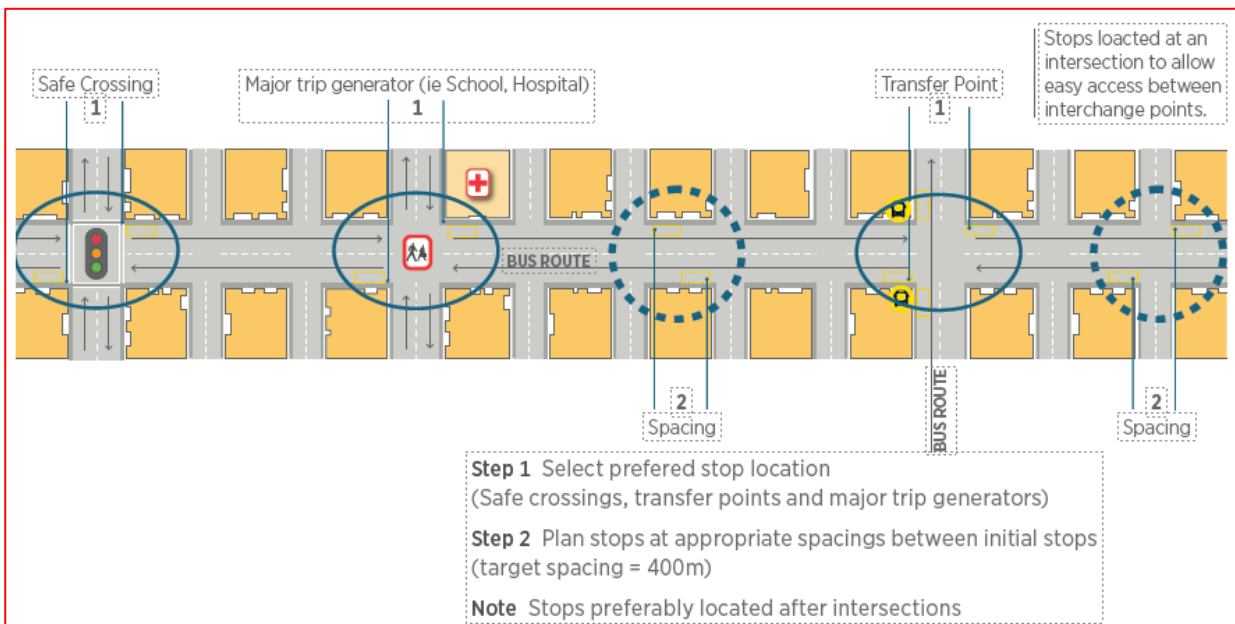

Figure 45: Good practice principles for bus stop spacing and location

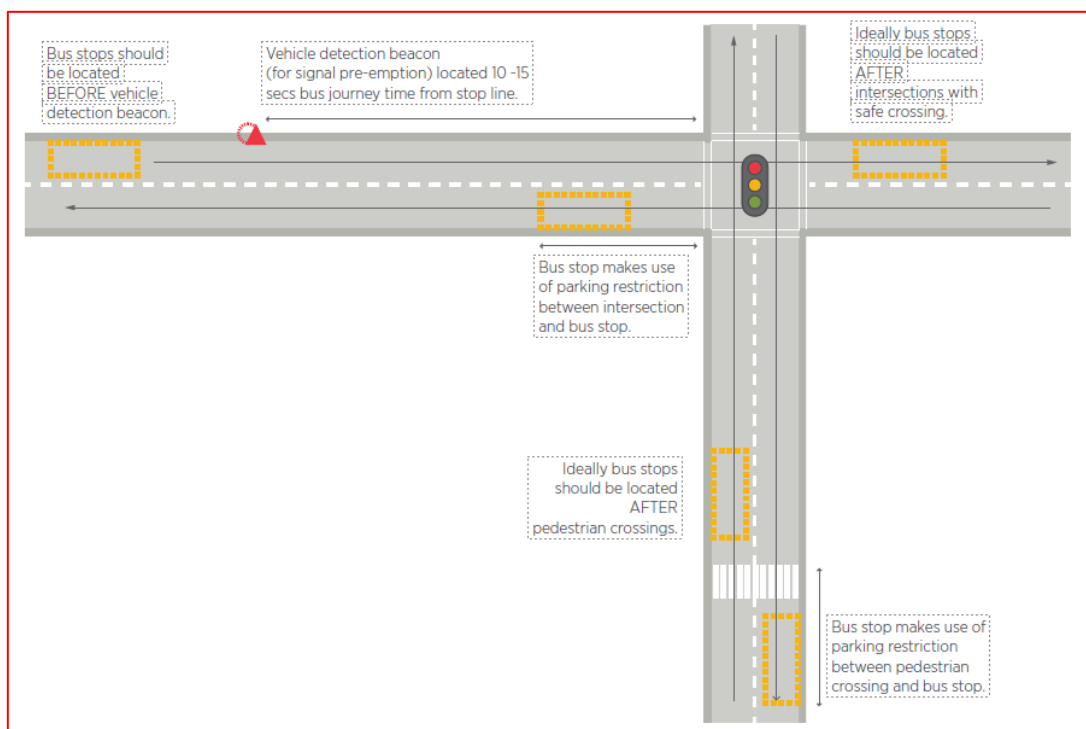

Figure 46: Good practice principles for bus stop spacing and location

Bus stops should ideally be provided in pairs, i.e. boarding and alighting stops must be in close proximity. Where possible, pairs should be tail to tail (see Figure 47), on opposite sides of the road. This is for safety and to allow sufficient space between the rear ends of bus stop markings for other vehicles to pass. Separation will depend on road width for safe deflection of vehicle path to pass a stopped bus. It will also depend on the opportunity and need to provide a safe crossing point.

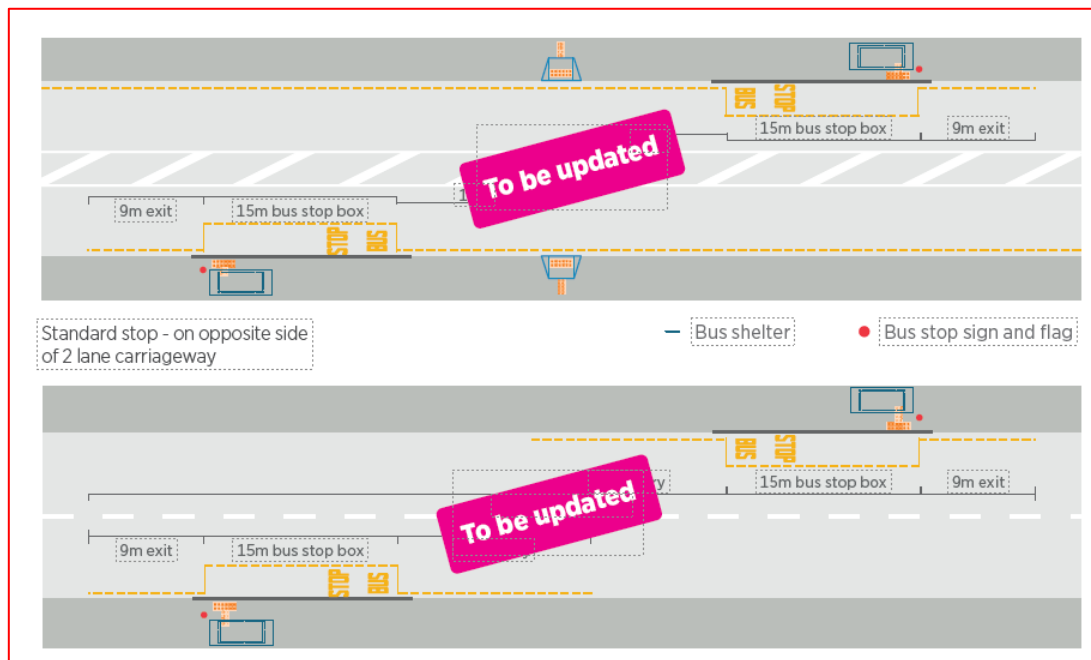

Figure 47: Tail-to-tail bus stop layout

3.6.3.6 Where bus stops should be located

- **Road safety**
 - Bus stops must be located where the road geometry provides safe sight lines for approaching vehicles and bus drivers. If this creates blind spots or blocks sight lines for pedestrians and drivers along the road, bus stops must not be located near a corner, curve, hill/gully, traffic island or intersection
 - Sight line assessment should be undertaken in accordance to Austroads Part 4A²¹.
- **Crime prevention:** Bus stops and shelters should be located to minimise the opportunity for crime and to increase the perception of personal security. Therefore, locate bus stops:
 - In clearly visible locations, e.g. away from tall vegetation (or remove it) and other objects that can be used to hide
 - In well-lit areas, e.g. near street lighting or other existing sources of illumination, if the stop does not have its own illumination
 - Near activity centres, e.g. service stations, shops, rest homes, where natural public surveillance occurs. (However, note that some residential properties prefer to be screened from the stop).
- **Access and catchment:** Bus stops should be located where they:
 - Are easy to access
 - Maximise their catchment, i.e. where there are many people near the bus stop

²¹ *Unsignalised and signalised intersections*

- Within close proximity to on-street pedestrian facilities (signals, refuge islands) to promote safe crossing movements for pedestrians transferring between public transport services.
- **Walking route**
 - The walking route to and from the bus stop should be as direct as possible. To this end, locating stops near intersections, can reduce the distance that passengers have to walk and help passengers complete the rest of their journey safely
 - Coordinate the location of bus stops with neighbourhood walking and cycling path connections and building entrances. If there are no existing paths, investigate the feasibility of creating new pedestrian and cycling short cuts to bus stops. Look for opportunities to link these with the wider pedestrian and cycling network.
- **Trip generators**
 - Bus stops should be located as close as possible to all major trip generators and key community facilities, e.g. places of employment, retail, commercial and educational centres, community halls, pools, sports centres, parks, libraries, day care centres, rest homes, medical centres, hospitals, pharmacies, etc.
- **Transport links**
 - Where relevant, bus stops should be located to encourage transfers between buses, trains and ferries. Therefore, they should be close to where different bus routes or other passenger transport services intersect, to minimise walking time for transferring bus passengers
 - Routes for transfers must be legible, accessible and with minimal delays.
- **Taxi stands**
 - Bus stops should be located in front of taxi stands. Positioning taxi stands in front of bus zones will result in taxis queuing back into the bus zone.
- **Footpaths**
 - There must be even and paved footpaths to bus stops that are accessible to wheelchairs and prams. This may require new footpaths or reconstruction of existing ones of poor quality.
- **Pedestrian crossings**
 - There should always be a pedestrian crossing close to the bus stop. This can be informal (e.g. pedestrian refuge island) or formal (e.g. signalised crossing or zebra crossing). Where there are none, consider providing a new accessible road crossing. The only exception may be bus stops on low trafficked roads in residential areas, which should have low operating speeds.
 - At pedestrian crossings, bus stops should be located on the departure side to reduce the risk of passengers crossing the road in front of a stopped bus. The bus stop shall not be on the crossing or within 6 m of it.
- **Grade separation**
 - If bus stops are to be located on high traffic or high-speed roads where signalised crossings are not practicable, a grade separated crossing (footbridge or underpass) may be considered.

- This is likely to be appropriate only near transport Interchanges or associated with major developments. Consideration should be given to the length of the accessible route using the crossing. Lifts may be considered only at Interchanges or where provided and maintained by private development management.

3.6.3.7 Special cases: Intersections and pedestrian crossings

Intersections

The location and placement of bus stops within close proximity of intersections should always be considered on a case-by-case basis. Bus stops should not be located opposite T-Intersections. At intersections, bus stops should be located on the departure side (i.e. past the intersection), as this will:

- **Improve safety:** The bus clears the intersection, blocking fewer movements and sight lines
- **Reduce traffic delays:** The bus clears the intersection, blocking fewer movements
- **Assist bus movement:** Reducing bus delays, e.g. a bus that must turn right at an intersection on a multi-lane road may have difficulty reaching the right-hand lane from a kerbside stop just before the intersection (see Figure 48 below).

Conflicting users

Some sites may be undesirable for bus stops due to potential use by other conflicting users, e.g.:

- Near an area that generates large amounts of short-term, high-turnover parking, e.g. ATMs, dairies and lotto shops. This is because visitors to such locations often park illegally at bus stops
- On the approach side of a high-use vehicle access, where bus operation and pedestrian safety may be compromised by turning movements
- Near a tourist facility visited by many coach or charter buses. Where both urban and coach services need access to the tourist facility, separate locations should be provided for them.

Bus timing points

- Bus timing point stops can affect adjoining landowners negatively and hinder the operation of intersections.
- Where possible, bus timing points should be located away from residential or other sensitive frontages, i.e. where continuous noise and disturbance or visual blocking are undesirable. Bus timing point stops must not be located across driveways.

Bus parking

- Bus parking must be provided away from service stops for buses not in service, as required for operational reasons. Locations must be discussed with AT Metro and should usually be close to welfare facilities as well as convenient for access to the first bus stop for each service supported by the parking.
- A bus stop parking sign (PP2) should be installed instead of a bus stop sign (RP-5).

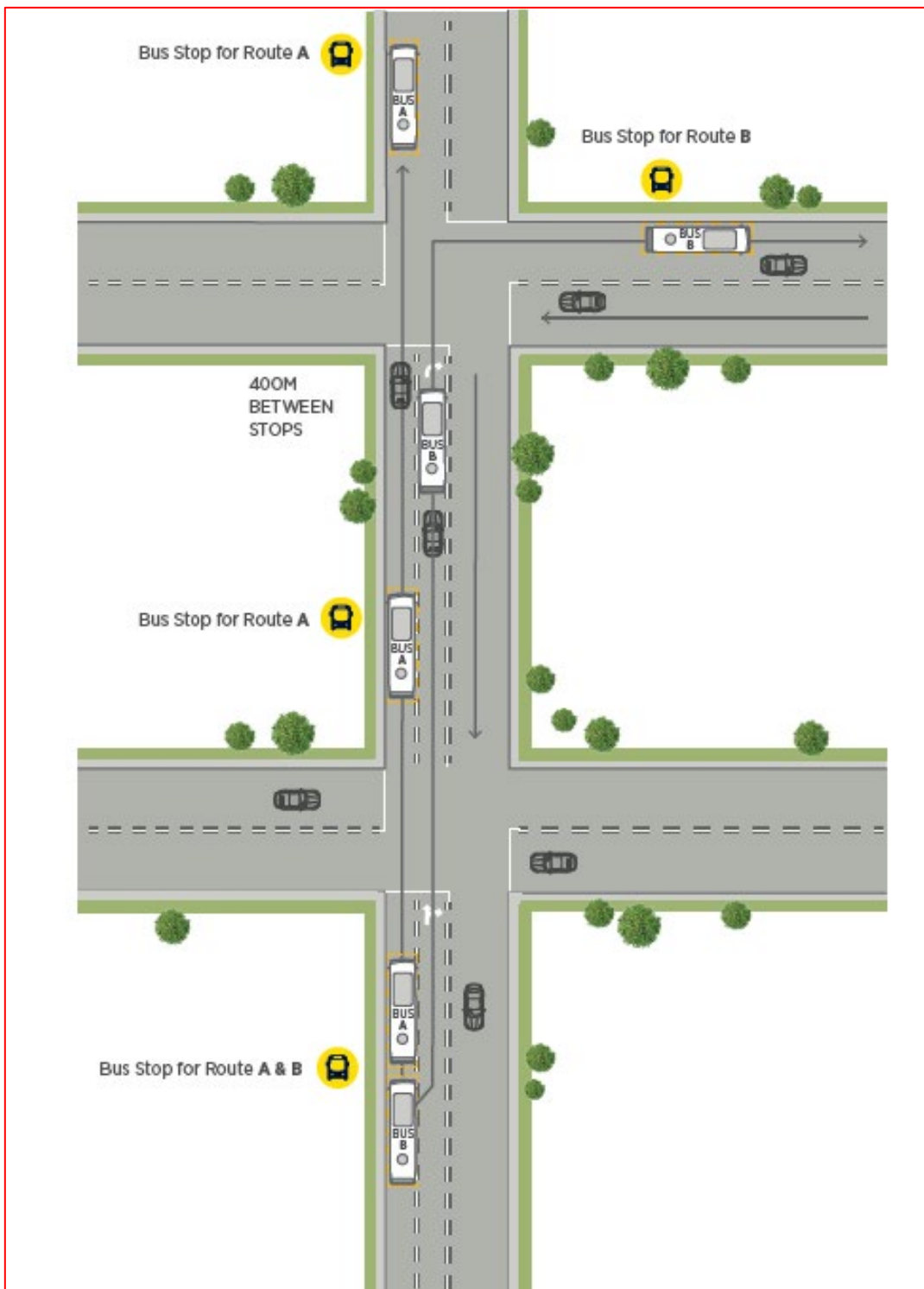

Figure 48: Bus stop crossroad placement

3.6.4 Bus stop layout

This section gives guidance on the appropriate bus stop layouts to use in different circumstances. The layouts below apply to urban conditions, i.e. roads with posted speed limits up to 70 km/hour, and for a 13.5 m bus. If other bus dimensions are used, the designs may have to be adjusted accordingly.

Appropriate bus stop layout – together with other measures such as kerb heights, road markings, etc. help the bus to stop close and parallel to the kerb, making it easier for passengers to board and alight. Every bus stop layout should be long and straight enough to allow a standard bus to pull in at the correct angle, so that it can stop closely parallel to the kerb and manoeuvre out of the stop safely. Buses should also be able to approach, and leave stops without delay or obstruction and without sweeping over the kerb with either front or rear overhang.

The ideal bus stop layout should:

- Maintain road safety
- Minimise bus dwell time
- Minimise the use of kerb space where there are competing demands for frontage access
- Prevent or dissuade other vehicles from parking in the bus stop area
- Allow the bus to align and stop parallel to the kerb within 200 mm without overhanging or over-running the footpath.

In practice, buses are often prevented from achieving the ideal for two main reasons:

- The bus layout geometry is poor
- Vehicles are parked close to or at the bus stop, preventing buses from reaching the kerbside.

Failure to align the bus properly with the bus stop can result in the bus driver either stopping too far away from the kerb or being forced to pull in or out of the bus stop at too sharp an angle. This impacts on:

- **Accessibility:** A bus that has stopped some distance away from the kerb, leaves a large stepping gap for passengers
- **Efficiency:** For the reason above, passengers may take longer to board or alight from the bus. This, in turn, may impact on the general flow of traffic
- **Safety:** A bus that has pulled into a bus stop too sharply due to an inadequate or obstructed approach taper, often ends up with the rear of the bus poking out into the traffic lane, restricting the flow and safety of passing traffic. Conversely, when pulling out to re-join the traffic lane, inadequate exit tapers can result in the vehicle tail overhang hitting pedestrians or street furniture on the adjacent footpath.



Figure 49: Failure to align bus properly and pull in at a sharp angle.

If the minimum dimensions outlined in this section cannot be achieved due to site-specific constraints, there may be an option to:

- Remove additional on-street car parking and other barriers to provide the space required to facilitate optimal bus positioning at a stop
- Relocate the bus stop slightly forward or back to where the minimum dimensions can be provided. This requires approval from AT Metro
- Widen the footpath, so that pedestrians can walk by without being potentially hit by bus overhang
- Using a paving treatment or road marking to delineate the overhang area.

The length of the bus stop area will have to be amended if more than one bus is expected to serve the stop at the same time. Sufficient space will usually have to be provided for the second (or third) bus to pull out past the bus in front (see Section 3.6.3.4 for advice on bus stop capacity).

3.6.4.1 Bus stop layout types

The main types of bus stop layouts are:

- Kerbside
- Bus boarder
- Indented bus bay.

Kerbside bus stop

A kerbside bus stop is one where the line of the kerb does not deviate for the bus stop. This is the preferred bus layout for most urban and suburban streets. Most stops in the Auckland region are kerbside stops. Entry and exit spaces are required where the bus needs to pull out of a traffic lane to the kerbside.

These stops should be marked out with the appropriate road marking and signs (see Section 3.5.5: *Intersections*). Layout dimensions are provided in Figure 50 and Figure 51 below. 'No stopping at any time' is required over the length of entry and exit space for clearways and part-time Special Vehicle Lanes for bus operation at other times.

Entry and exit lengths in Figure 50 and Figure 51 are based on standard parking bays. These lengths must be increased by 0.4 m for every 0.1 m width of bay over 2.1 m.

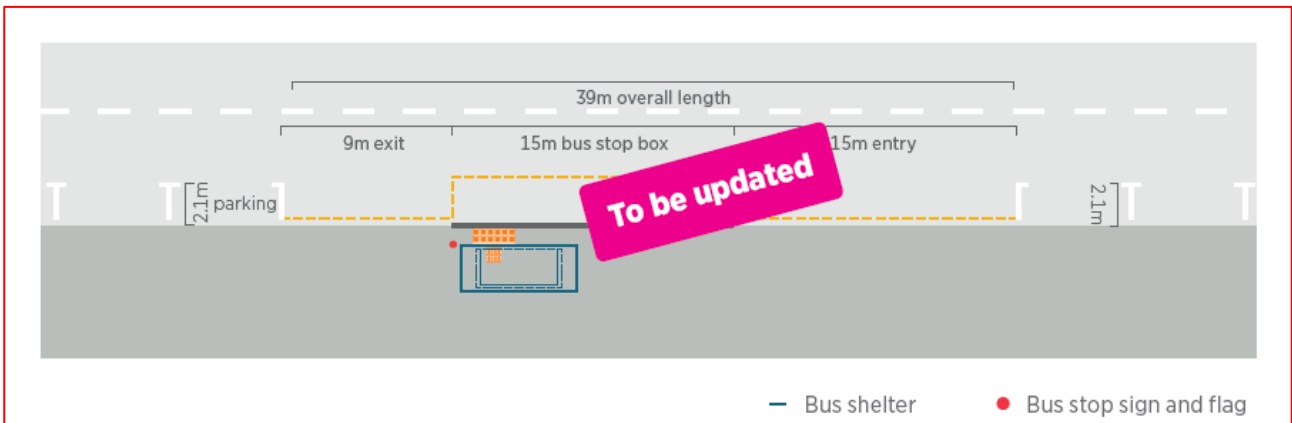

Figure 50: Kerbside bus stop with parking either side for a standard 13.5 m long tag-axle bus

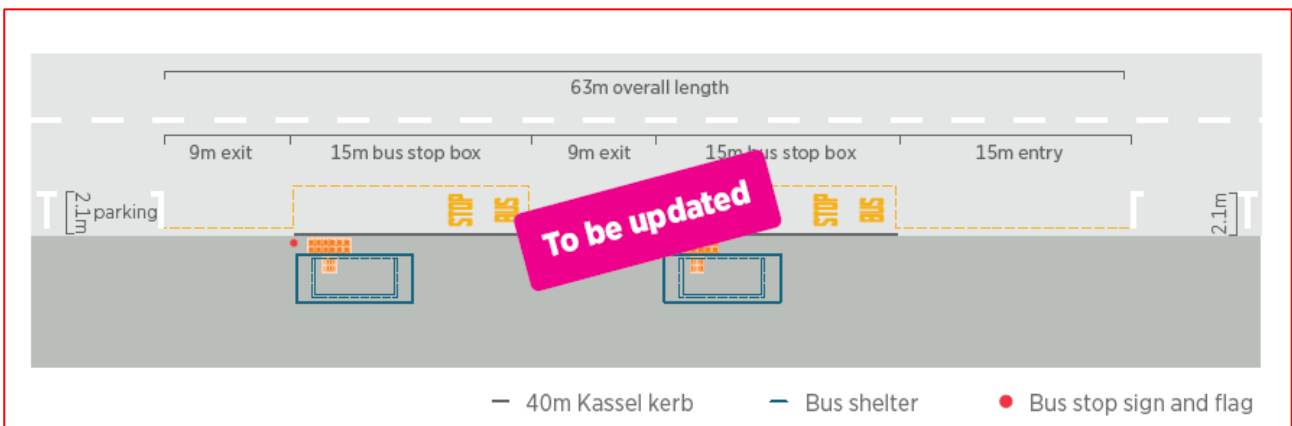

Figure 51: Kerbside bus stop with parking on either side for two standard 13.5 m long tag-axle buses

The length of kerb required to be restricted against other activities can be minimised by making use of existing clear spaces, such as driveways, and parking restrictions imposed near to pedestrian crossings and intersections. This aids bus access, while minimising the length specifically required for a bus stop. They also have the advantage of placing stops near to where passengers may wish to cross the road (Figure 52 and Figure 53 below).

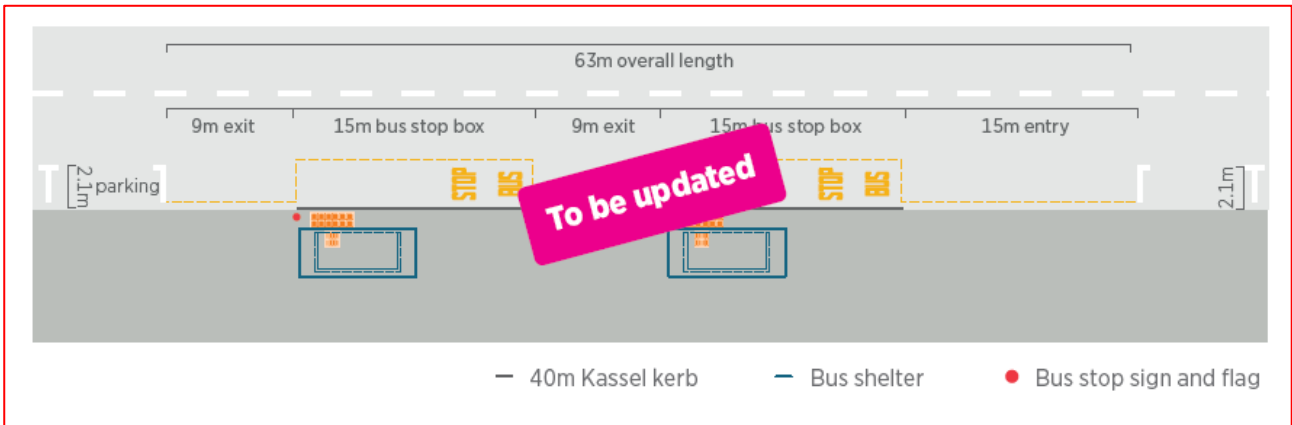

Figure 52: Kerbside bus stop with parking either side for a standard 13.5 m long tag-axe bus

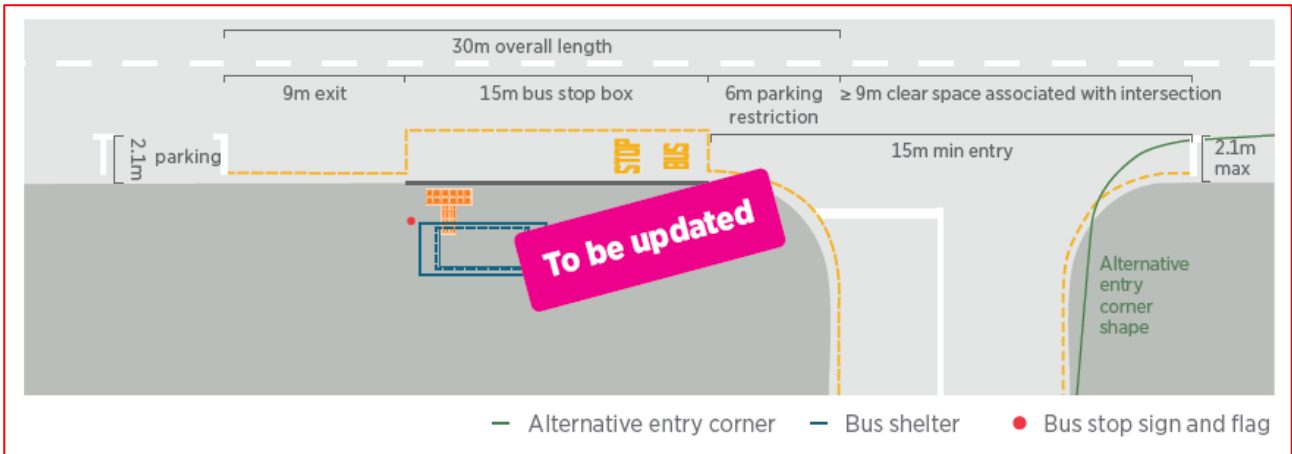

Figure 53: Kerbside bus stop on exit side of an intersection

Bus boarders

Bus boarders are areas of footpath built out into the carriageway, so that the bus does not have to pull out of the traffic lane. Bus boarders can be full width (minimum 2.1 m wide) or half width (0.5 - 1.5 m wide).

Full-width bus boarders are shown in Figure 54 and Figure 55.

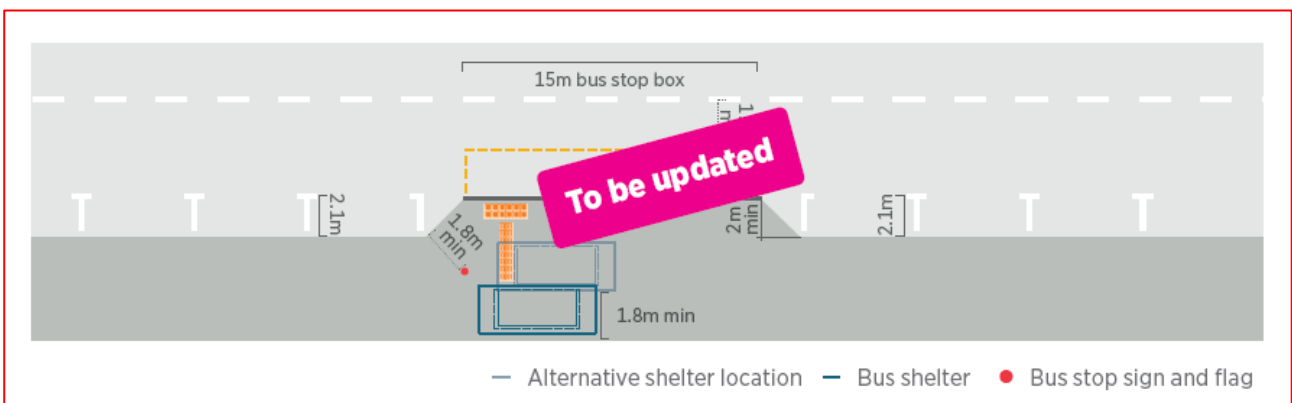

Figure 54: Full-width bus boarder for a single standard 13.5 m long tag-axe bus

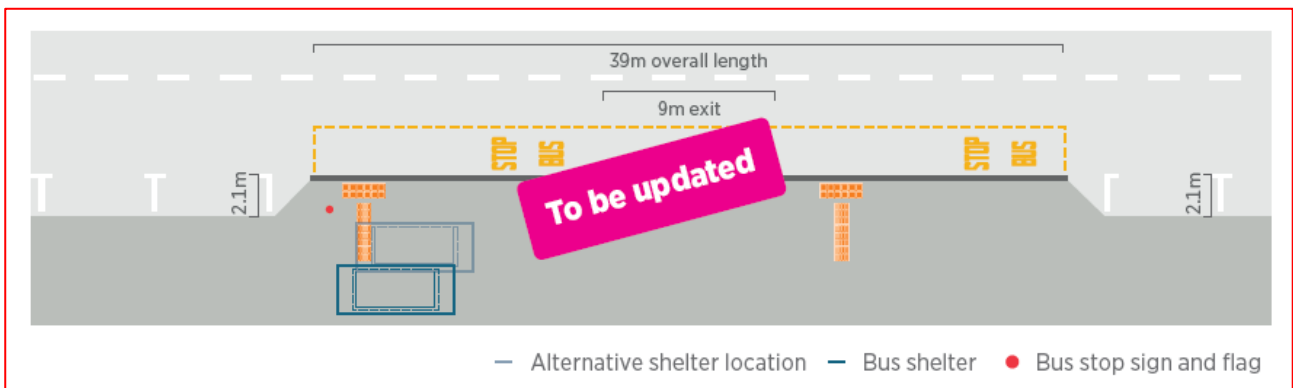

Figure 55: Full width bus boarder for two standard 13.5 m long tag-axle buses

Bus boarders are used because in some locations, buses have difficulty manoeuvring to the kerbside, due to inconsiderate parking or loading vehicles at or near the bus stop. A bus boarder layout can help to resolve this problem, and to provide more kerbside parking space where demand is high. Bus boarders may also be appropriate where buses have difficulty re-entering the traffic flow.

Bus boarders are suitable where:

- The posted speed limit is 50 km/h or where actual traffic speeds are below 50 km/h due to congestion, etc.
- The traffic lane is at least 3.5 – 4 m wide. This allows at least 1.5 m of road space between the lane or centre line and the side of a stationary bus for on-road cyclists to pass
- Both bus numbers and kerbside parking demand are high. Generally, this occurs in a CBD or town centre
- Traffic calming measures are required to help reduce traffic speeds, unless the resulting delay is onerous to other buses and general traffic
- Footpaths are narrow, causing conflict between waiting passengers and passing pedestrians.

The advantages of bus boarders are:

- They provide an effective deterrent to inconsiderate kerbside parking/loading at the stop itself
- Full width bus boarders require the least kerbside length of all the layouts, as there is normally no need to provide for entry and exit space. Figure 54 above shows that full-width boarders only require a 15 m kerbside length, whereas half-width boarders (see Figure 56 to Figure 58 below), require a total kerbside length of 32 m, which is still less than the 39 m required by kerbside bus stops
- Due to the above, buses can approach the bus stop in a straight line and align close to the kerb, ensuring good accessibility for all passengers
- Higher kerb platforms can also be installed without risking damage to buses as the bus will never need to overhang the kerb. The reduced height differential allows easy boarding and alighting and can reduce bus dwell time
- They create passenger waiting areas that do not impede or conflict with the pedestrian flow on the footpath. Bus infrastructure can also be provided off the main footpath

- The wider footpath provides opportunities for improved customer waiting facilities, attractive streetscapes, landscaping, cycle parking and street furniture
- They act as traffic calming devices by narrowing the road.

Bus boarders can cause some delay to traffic in the kerbside lane. However, on corridors where the movement of people is prioritised over the movement of vehicles, this should not be a deterrent to their application.

Where a boarder is desirable, but kerbside space is very restricted, then AT Metro is prepared to consider a boarder of reduced length, subject to an absolute minimum of 10 m at the outer kerb face.

Half-width bus boarders are often a useful compromise solution. The build-out from the kerb can range from 500 mm up to the width of a full boarder, although they are commonly 1–1.5 m wide.

A minimum width of 1.5 m between the end of the bus bay and traffic lane should be provided to accommodate cyclists.

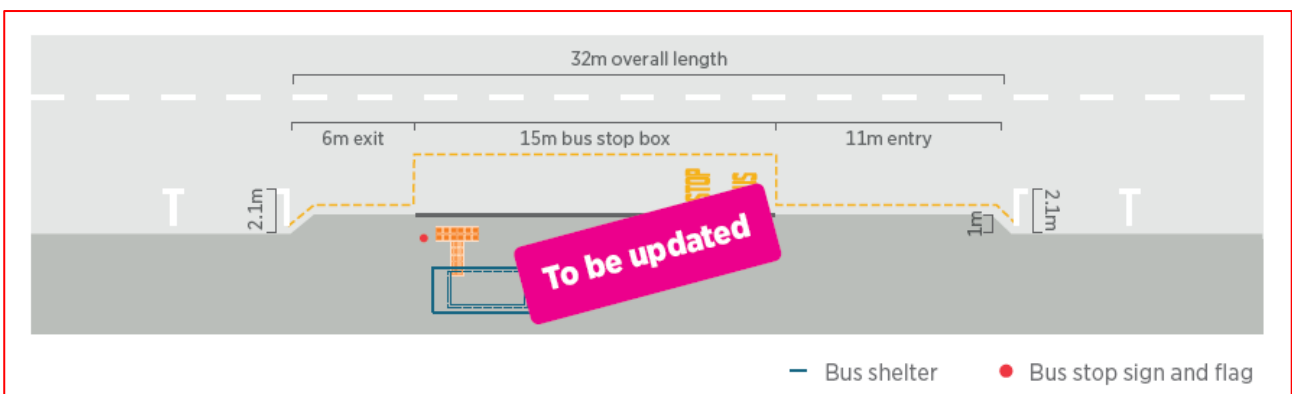

Figure 56: Half-width bus boarder for a single standard 13.5 m long tag-axle bus

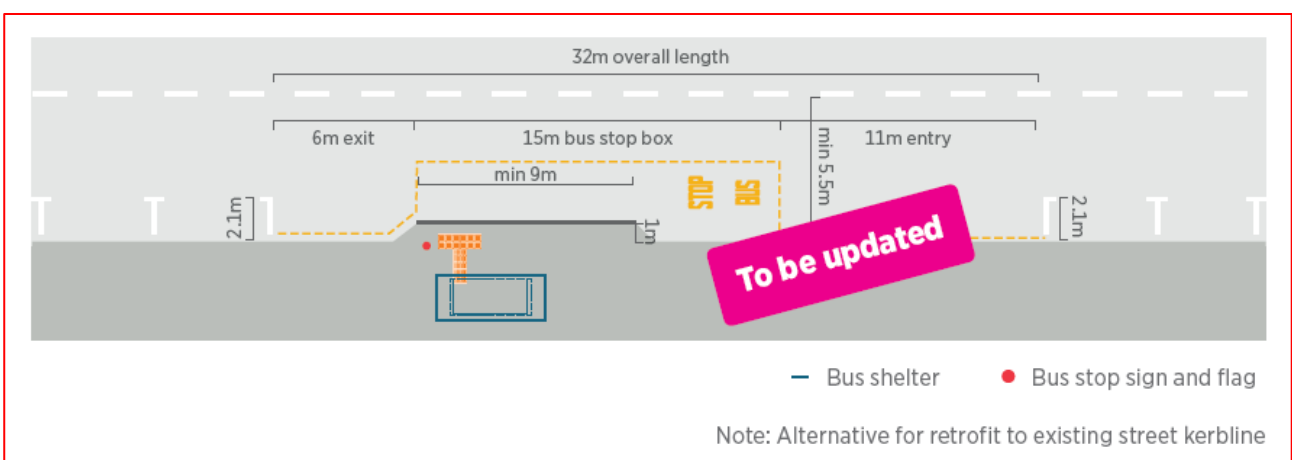

Figure 57: Half-width bus boarder – (Alternative 1) for retrofit to existing street kerblines

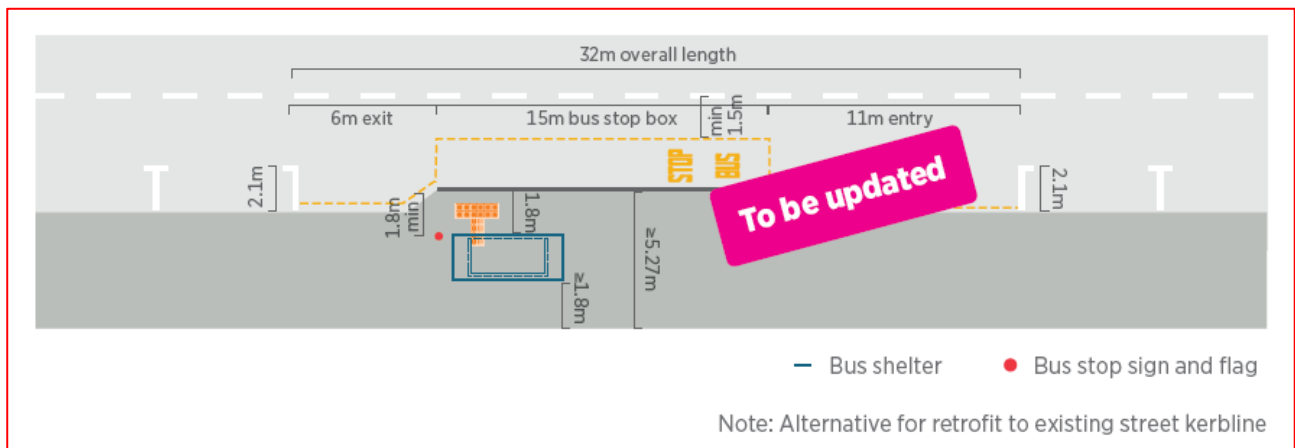

Figure 58: Half-width bus boarder – (Alternative 2) for retrofit to existing street kerblines

Half-width bus boarders should be used where:

- Frequent delays to other vehicles must be avoided
- A full-width boarder would place the bus in, or too close to, the opposing traffic stream
- There is on-road provision for cyclists, giving them a minimum passing width of 1.5 m between a stationary bus and the lane line.

Indented bus bays

Indented bus bays are set into the kerb, so that the bus is out of the traffic lane when it stops. Indented bus bays can be fully indented or partially indented. Note that where on-street parking is placed too close to a kerbside bus stop, the effect for the bus is just like an indented bus bay.

The purpose of indented bus bays is to remove buses from traffic lanes while they stop. This maintains the general traffic flow and improves safety where a stationary bus in the traffic lane would create a safety risk.

Bus bays, however, present inherent operational problems for buses and passengers. The disadvantages of this type of layout are:

- **Difficult merging:** Bus drivers often find it difficult to merge back into the main stream of traffic, causing delays at each stop, which adds considerably to overall journey times. This problem is particularly felt in Auckland, as drivers are not required legally to give way to buses. The variability of this hold-up leads to unreliable, delayed and bunched services. This effect is reduced where the kerbside lane is a Special Vehicle Lane, as the reduced density of traffic is likely to provide more opportunity for the bus to depart.
- **Wasted space:** Indented bus stops require a significant distance to ensure that buses can pull in 'flush' with the kerb. A standard bus requires a fully-indented bus bay area to be 63 m long from the start of the entry kerb to the end of the exit kerb. This means that there is less area available for wider footpaths, streetscape, berms, landscaping, or on-street parking.
- **Poor accessibility:** The design of many existing bus bays is unsatisfactory, particularly where their geometry prevents buses from reaching the kerb, which reduces accessibility for passengers.

Some drivers may also choose not to pull in close to the kerb, to ensure that the bus is at a better angle to re-enter the main stream of traffic.

- **Illegal parking:** Bus bays are prone to attracting inconsiderate parking or unloading, especially in high-activity areas such as town centres, shop frontages, etc. This prevents the bus from reaching the kerbside, forcing passengers to board or alight from the road, causing difficulties for some passengers.
- **Wider carriageway:** Bus bays widen the carriageway area, encouraging speeding, making it more difficult for pedestrians to cross, and detracting from the aesthetics of the street environment.

Requirements

Avoid full-indented bus bays wherever possible, as they reduce the efficiency of bus services. They should only be provided where justified by compelling safety or operational reasons, or where required on Special Vehicle Lanes, as outlined below.

Review all existing bus bays within the extent of any affected road in line with this guideline. Where possible, bus bays should be filled in and/or the stop relocated to address the original reasons for providing an indented bus bay. The additional footpath space can be used to improve the bus stop environment. Where indented bus bays have been provided on the grounds of poor sight lines for oncoming vehicles, bear in mind that bus drivers may also suffer from poor sight lines of oncoming vehicles at indented bus bays. This compromises safety when bus drivers try to re-enter fast-flowing traffic streams and increases journey times.

Fully-indented bus bays (Figure 59 and Figure 60) should only be considered:

- Where the speed limit is 80 km/h or higher. In these cases, ensure:
 - Good sight lines of approaching traffic
 - Lead-in and lead-out spaces provide for easy and safe manoeuvring of the bus out of and back into the main stream of traffic.
- Where possible, an indented bay should be situated immediately downstream of a traffic signal, to provide breaks in the passing traffic into which the bus can depart. Where the bus will have a long dwell time at a bus stop and will unnecessarily obstruct traffic flows. This may apply:
 - At busy bus stops with many passengers boarding and alighting or where large amounts of buses operate and it may be more efficient to indent stopping buses to allow others to pass, e.g. at city and town centres
 - For operational reasons
 - For schools and special events, due to long boarding times, as passengers all arrive at the same time.
- Where there is a significant crash risk for traffic overtaking a stopped bus conflicting with oncoming traffic. This may happen with poor sight lines due to curves or concealed entries.
 - It will usually be preferable to locate the stop differently rather than indent it
 - On high-frequency bus corridors where not all buses will need to call at every stop.

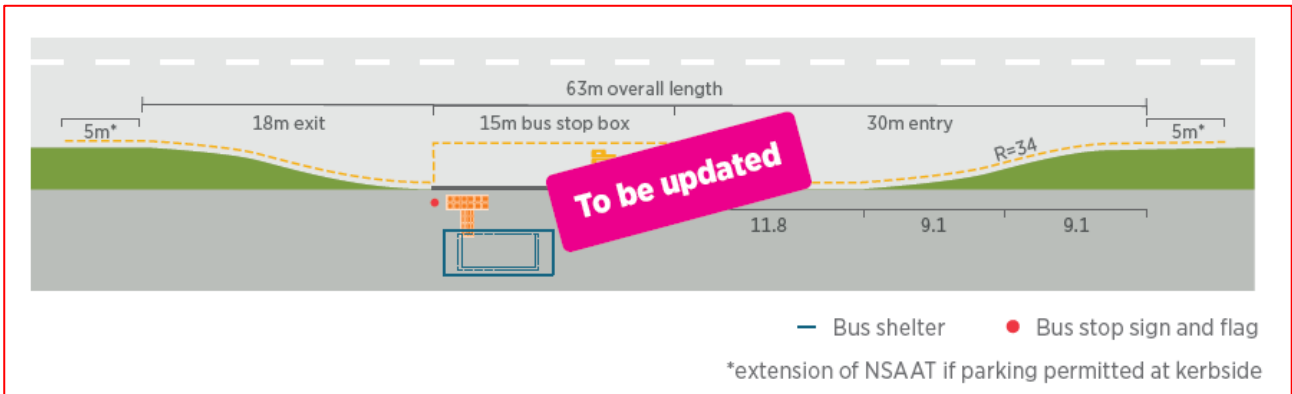

Figure 59: Fully indented bus bay for a standard 13.5 m long tag-axle bus

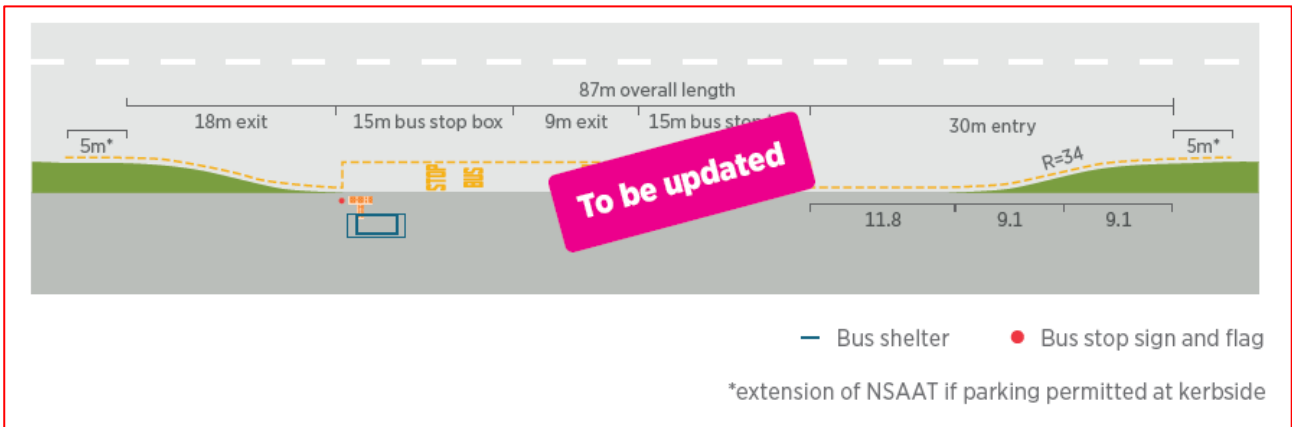

Figure 60: Fully indented bus bay for two standard 13.5 m long tag-axle buses

Half-indented bus bays may be considered where there is only one wide lane of traffic. A half-indented bus bay allows general traffic to overtake the stationary bus safely, while still keeping the bus within the main stream of traffic. It is particularly important to provide enough space for people on bikes to overtake stationary buses where there is on-road cycle provision unless an off-road bypass is provided (see Figure 61).

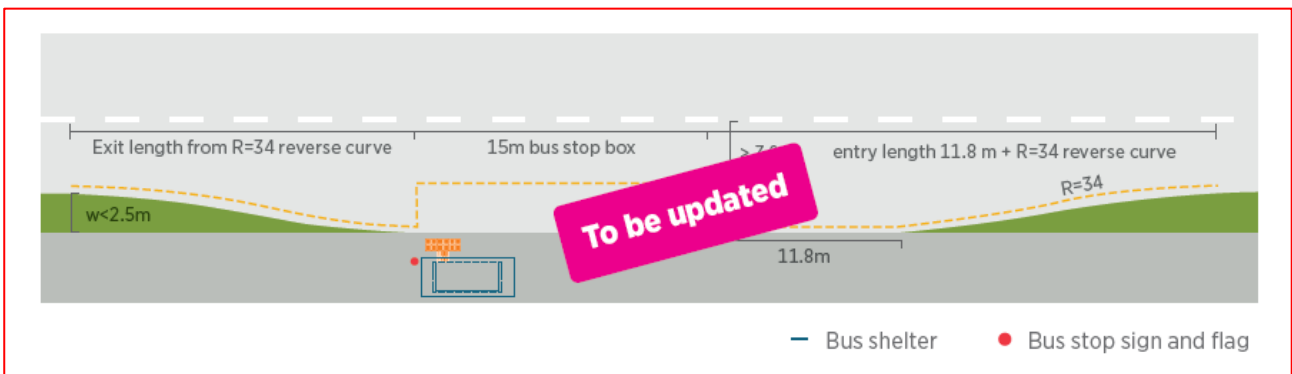

Figure 61: Half-indented bus bay for a standard 13.5 m long tag-axle bus

3.6.5 Bus stop signs and markings

This section outlines the markings required on the road area of bus stops. Bus stops are required legally to be marked out on the carriageway where the space reserved for the bus extends for more than 6 m on either side of a single bus stop sign. This will ‘in time’ include all bus stops in Auckland.

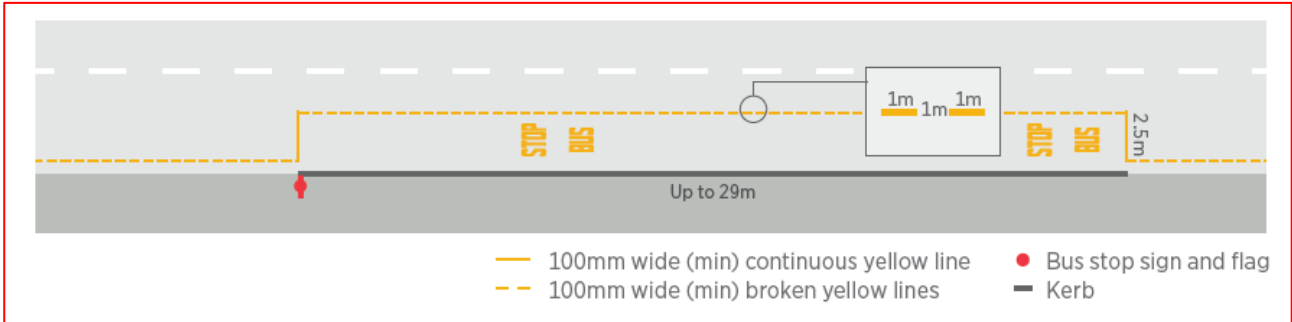

Figure 62: Sign and marking layout for bus stop up to 29 m

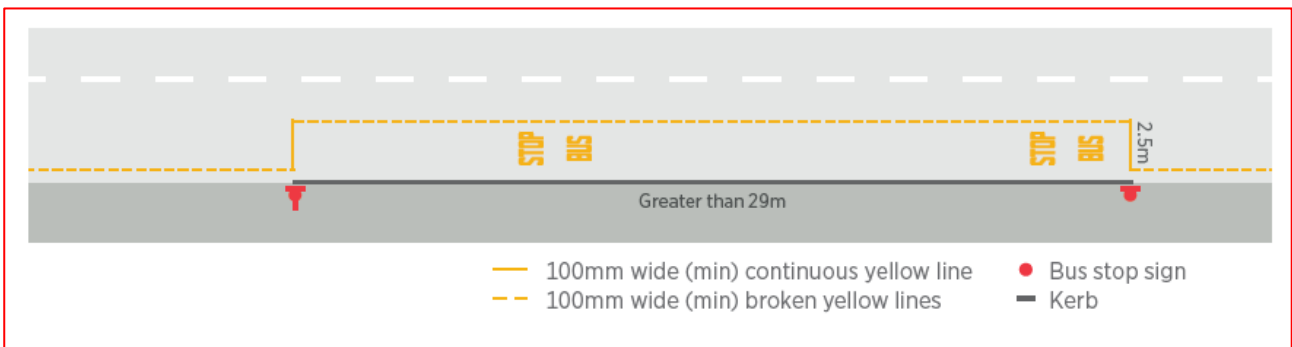

Figure 63: Sign and marking layout for bus stop longer than 29 m

3.6.5.1 Bus stop sign

The bus stop sign (RP-5, Figure 64) is required by law. It identifies the area as a bus stop. It is an important indicator to passengers, bus drivers and motorists and acts as a control point for the layout of bus stop.

The TCD rule for bus stops indicates anything over 6 m requires a bus stops sign and marking.

Bus stop sign placement

To minimise dwell time and improve boarding speed, it is critical that the sign is positioned at the head of the bus stop (ideally in line with the head of the bus box) so that the bus driver has a cue on where to stop and the passenger knows where the door will be. Signs which are not placed at the head of the stop may be hit due to front or rear overhang, therefore drivers will not pull up close to the kerb, which will result in greater step lengths required to board the bus.



Figure 64: Bus stop sign (RP-5)

The RP-5 signs must always be placed close to the head of the box and must always be at least 1 m from the kerb face. The bus stop sign must not be placed outside the box.

One or two signs

Up to a maximum box length of 29 m only one RP-5 sign is required, which must be placed at the head and display no arrow. When the bus stop box is longer than 29 m, signs must be provided at both ends and both must display an arrow pointing to the other.

3.6.5.2 Bus box road marking

The bus box is the outer perimeter of the declared bus stop. It must be marked out in broken yellow lines as per the design standards in the *Land Transport: Traffic control devices rule*.

This helps create a consistent environment at the bus stop. Bus drivers will know to stop their vehicle at the head of the box, which is where key infrastructure components are provided, e.g. clear stand areas, raised kerbs and tactile ground surface indicators if used. This is particularly important for disabled or vision-impaired passengers.

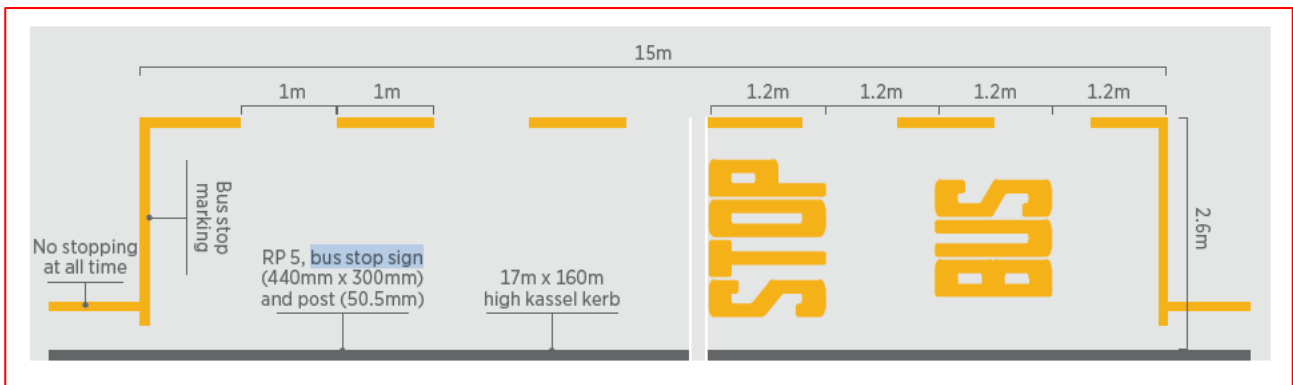

Figure 65: Typical Bus box marking

The dimensions of the bus box should be as shown in the layouts above.

3.6.5.3 No stopping at all times road marking

The 'no stopping at all times' road marking consists of broken yellow lines. Used either side of a bus box, they ensure that the lead-in and lead-out remain unobstructed, and the bus can approach and depart from the bus stop correctly. They should also be used in part-time clearways and part-time special vehicle lanes.

3.6.5.4 Bus stop road text

The words "BUS STOP" are applied on the road surface within the box in order to make clear to road users the function of the box. Auckland Transport has adopted the single-sign form of marking bus stops up to 29 m, plus one set of road text per 15 m. It is also an important means of identifying to drivers and pedestrians that the road is used by bus services and can therefore encourage compliance.

3.6.5.5 Coloured surface treatment

The profile of the bus box area can be raised further by highlighting the area with coloured surface treatment. This makes the bus stop area more prominent to passengers, bus drivers and other drivers. Although the treatment imposes additional costs, the raised profile of the stop may prove an effective deterrent to illegal parking and reduce enforcement problems. Auckland Transport strongly recommends the use of this surfacing at bus stops with a high potential for road user conflict.

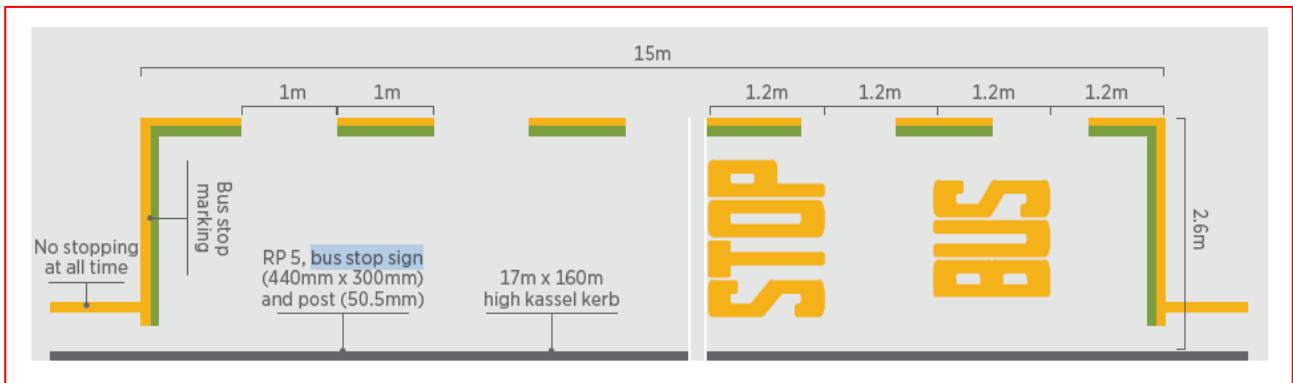

Figure 66: Bus box with coloured surface treatment

3.6.6 Bus stop types

This section outlines the different bus stop types in Auckland and the provision of amenities at each type of stop.

In terms of the infrastructure they require, AT Metro divides bus stops into three main types, to help determine the appropriate level of bus stop infrastructure.

Table 37: Bus stop types

Type name	Passenger volume	Bus frequency	Area serviced
Signature	Moderate to high	High (every 2 to 15 minutes)	Local, district and regional areas on Frequent Service Network
Regular	Moderate	Moderate to high (at least every 30 minutes)	Suburban areas and attractions (e.g. shopping centres), and/or on Frequent Service Network.
Standard	Low	Low (less than every 30 minutes)	Suburban, outer suburban or non-urban areas

3.6.6.1 Inbound vs outbound

Away from the major trip attractors and urban centres, AT Metro differentiates between inbound and outbound bus stops, at which customers have very different needs for roadside amenities.

'Inbound' stops are those from which customers catch buses to destinations or interchange points: typically, they are on routes inbound to a suburban centre, major shopping destination or the CBD. 'Outbound' stops are those to which people travel, disembark and immediately disperse. For these reasons, at inbound or interchange stops a higher level of waiting facility is to be expected; whereas at outbound stops customers are unlikely to spend any amount of time.

On routes between significant trip attractors, it is likely that most stops could be considered 'inbound' in either direction, whereas on a route that terminates in one of the outer suburbs there is likely to be a clearer distinction between stops where customers board on one side of the road, and alight on their return at the other side.

Where a service runs in a one-way loop run from an interchange hub through local suburbs back to the hub all stops can be described as inbound.

3.6.6.2 Bus stops for school route

On routes that are served by school buses only, stops must still be laid out to facilitate safe and efficient access both for the bus and the customers. It is likely that the parking restrictions formed by the stop box and the lead-in and out might not be necessary nor desirable during the rest of the day. This can be designed by forming the three elements into a single long box of at least 39 m and making that single box effective for during school morning pick-up (8:00 to 9:30am) and afternoon (2:30pm to 3:30pm) drop-off periods, to suit the required hours of the school service. This avoids the unnecessary use of 'no stopping at all times' markings that cannot be time-limited.

A normal bus stop sign can be used with a supplementary restriction.

There is a strong demand for shelter to protect children from inclement weather, despite an infrequent need (once per day). It is desirable to provide shelter at all inbound stops used as boarding points by school children. This includes the stop close to the school from which children board their return buses in the evening. These will often need a larger shelter, probably of at least Intermediate size.

While most bus stops will be of a standard type, busier or more complex locations will require a degree of professional judgement in conjunction with the advice and specification of AT Metro as the client.



Figure 67: Schematic illustration of a Signature stop

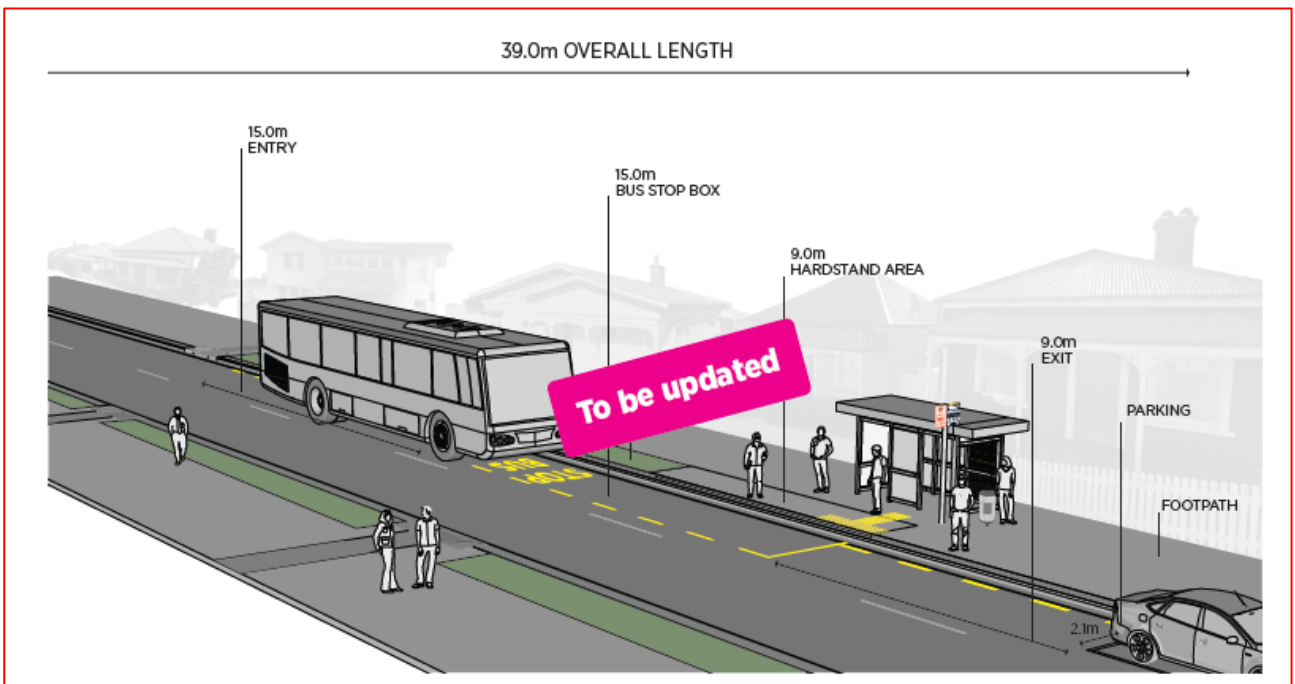

Figure 68: Schematic illustration of a Regular bus stop



Figure 69: Schematic illustration of a Cantilever Shelter bus stop



Figure 70: Schematic illustration of a no shelter bus stop

3.6.6.3 Traffic calming

Traffic calming implemented on bus routes should consider the comfort for both drivers and passengers. Features should not be located too close to a stop, where passengers may be standing up while the bus is moving. AT Metro typically accepts ramp heights of 100 mm (1 in 15) and 75 mm (1 in 10). For additional information on the height, length and type of traffic calming measures appropriate along bus routes, refer to Section 3.7: *Traffic calming*.

3.6.6.4 Preferred layouts

- Do not attach bus stop signs nor customer information to lighting columns either/or power poles. These items must remain under the control of AT Metro on an independent pole or on the bus shelter and positioned appropriately to fulfil the needs of TCD and customer service.
- At stops for multiple buses allow a clear standing area for customers at the position at which each bus will stop.
- A clear walking route at least 1.8 m wide must be provided where possible. A reduced width of no less than 1.5 m should only be considered where existing constraints prevent a wider path and where conflict between through movement and bus boarding is not significant.
- Vehicle crossings must never exist within the forward 9 m of a bus stop. It is preferable (but sometime unavoidable) to have no vehicle crossings within any part of the 15 m length of a bus stop box. Crossings should never be made through a length of Kassel kerb. At timing points or termini, no part of the 15 m box can be over a driveway.
- Street trees should be located clear of the through route and boarding spaces. Tree trunks must remain at least 1000 mm inside the face of the kerb if within the 15 m length of a bus stop box. It is preferred not to design new stops to have street trees within the 15 m box at all. No new street tree is to be permitted within the 15 m length of an existing stop. Tree canopy must be capable of being maintained clear of the bus envelope for entry, stopping and exit.
- Trees and other street furniture must not obstruct sight lines between people waiting at the bus stop, and the driver of an approaching bus.

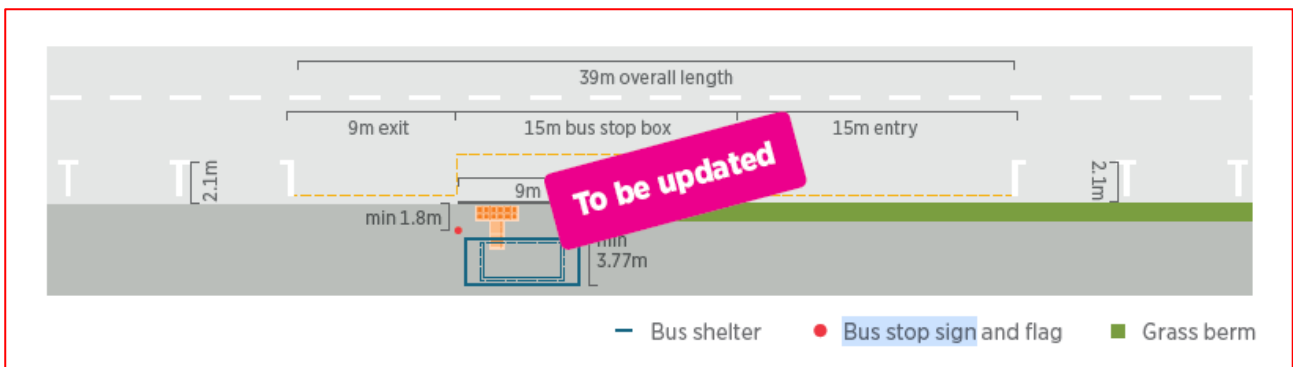

Figure 71: Schematic illustration of a Standard bus stop

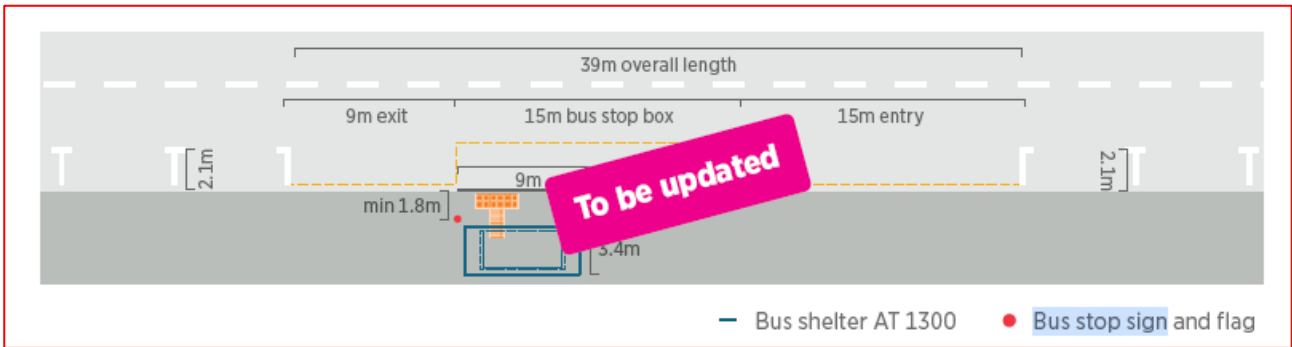

Figure 72: Layout for a standard kerbside bus stop at a constrained site

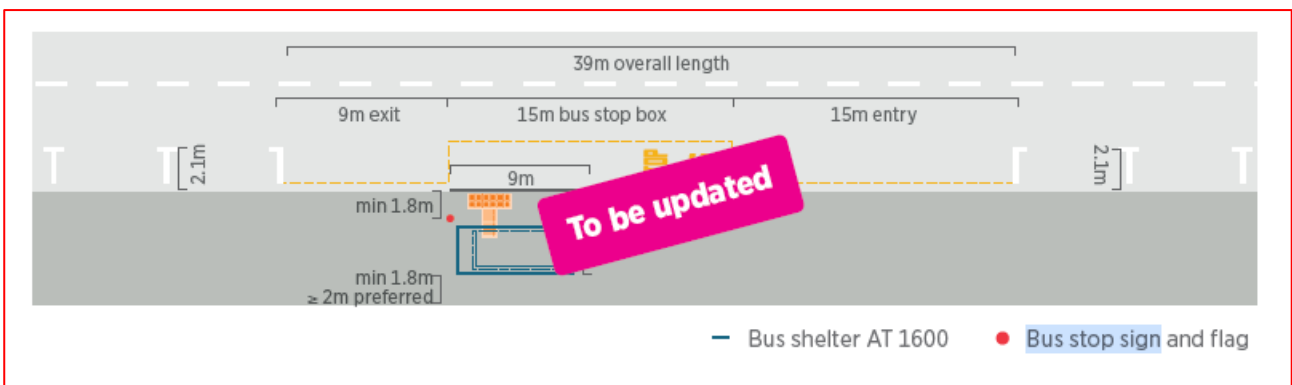

Figure 73: Layout for a standard kerbside bus stop with a wide divided pedestrian route

3.6.7 Bus stop elements

Legal requirements for the enforcement of parking controls at bus stops are the presence of a single RP-5 sign at the head of the box; the stop box; and the road text ‘BUS STOP’. Other components are required by AT Metro to meet customer service standards.

Table 38 below outlines the infrastructure provision for each of the three types of bus stops described, in principle. Relevant factors listed elsewhere in this chapter will have to be considered as well.

Table 38: Infrastructure provision for different bus stop types

Component	Signature Stop	Regular Stop	Standard Stop
Accessibility			
Minimum kerb height at front door (and ideally rear door): 150 mm for normal kerb, 160 mm for Kassel kerb	M	M	M
Paved clear stand area	M	M	M
Tactile ground surface indicators	M	M	M
Connecting footpath to/from bus stop	M	M	M
Pedestrian crossing close to bus stop	M	M	R
Signs and road markings			
Bus Stop sign (RP-5)	M	M	M
Bus box road marking	M	M	M
No Stopping at All Times road marking	M	M	M
Bus Stop road marking	M	M	M
Coloured surface treatment			
Safety & security			
Street lighting	M	M	R
Shelter with lighting	M	R	P
Emergency help point	P	P	O
Public telephones on-site or nearby	P	P	O
Video surveillance	P	P	O
Street furniture			
Seating	M	M	P
Shelter	M	R	O
Rubbish bin	R	R	O
Ticket machine	R	P	O
Shopping trolley bay	O	O	O
Cycle parking	P	P	O

Component	Signature Stop	Regular Stop	Standard Stop
Stop-specific information			
Stop number	M	M	M
Direction of travel	M	M	M
Site-specific fare information	M	M	M
Stop-specific timetable (departure times)	M	M	M
Stop-specific route diagram(s)	M	M	R
Information telephone number/ web address	M	M	M
Stop name	M	M	M
Wider area fare information and zone map	M	M	R
Wider area route map	M	R	P
Real time information signs	M	M	P
Enhancements			
Landscaping	O	O	O
Public art	O	O	O
Community notice board	O	O	O
Vending machine	O	O	O
	M Mandatory	R Required	P Preferred O Optional

3.6.7.1 Bus stop kerbs

The kerb should:

- Provide safe delineation between the road surface for vehicle movement and the footpath or waiting areas for passengers and pedestrians
- Provide good guidance for the bus driver
- Reduce the step height between the bus floor and the bus stop to help passengers board and alight more easily
- Reduce the gradient of a deployed ramp for wheelchair users, people with prams, luggage or small children
- Facilitate quicker boarding and alighting, reducing bus dwell time and improving bus journey times and reliability.

Design standards

The Standard for New Zealand Design for Access and Mobility – Buildings and Associated Facilities (NZS 4121:2001) recommends:

- Step ramps formed between two horizontal surfaces must have a maximum slope of 1:8. (Note that variables such as crossfall of the footpath and carriageway can influence the gradient of a bus ramp.)
- Step ramps shall conform to the requirements for kerb ramps having a maximum length of 1520 mm
- The allowable camber for crowned and banked footpaths and ramps must have a maximum slope of 1:50.



Figure 74: Small gap between the kerb and bus floor make it easy for passengers to board or alight

Auckland Transport must be consulted before a decision is made on the application, suitability or specification of any kerb product in the bus network.

3.6.7.2 Kerb height

Kassel kerbs should be used for all proposed bus stops, all existing kerbs must be removed and replaced with Kassel kerbs.

Constraints preventing the use of a Kassel kerb must be notified to Auckland Transport for resolution.

Kassel kerb

The Kassel kerb is a concave-section accessible kerbstone that guides the bus tyres in the last few lateral centimetres of bus approach. As the tyre rides up the concave surface, gravity pulls it back down. Proper use of them can consistently achieve a 50 mm loading gap, without undue tyre wear. Another benefit of these kerbs is that they are clearly visible to the driver and help guide the driver to stop in the correct position relative to the bus infrastructure.

Auckland Transport has decided to install Kassel kerbs on parts of the public transport network.

Kassel kerbs must be used:

- In all new or upgraded bus stations, interchanges or town centre stops
- On any new busway or dedicated bus road projects
- At stops on the Frequent Service Network
- In any large-scale streetscape projects
- At every bus stop where existing kerb is being broken out as part of road works.

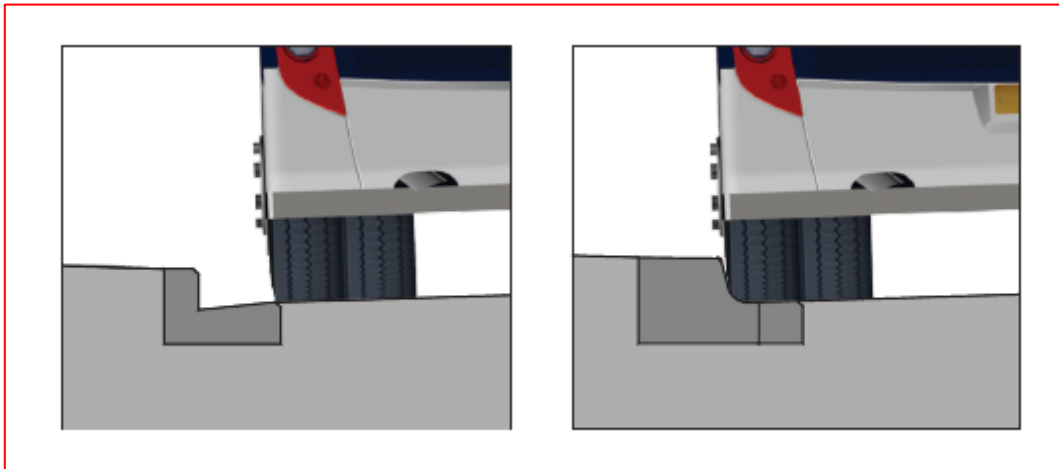

Figure 75: Standard and Kassel kerb profiles

Kassel kerbs are available in different heights, 160 mm and 180 mm being most common. Auckland Transport's preferred height for a Kassel kerb is 160 mm, although there may be site-specific circumstances where a higher kerb is appropriate.

High special kerbs of more than 160 mm should only be provided at bus stops where buses always have clear, unimpeded access on the approach and departure from the boarding point, with no likelihood of any obstruction that would prevent the bus arriving parallel to the kerb without hitting it. This must be designed in consultation with Auckland Transport Design & Standards.

3.6.7.3 Installing higher kerbs

Raised kerbs are required for the length of the clear stand area. Kassel kerbs should be provided for the full length of the bus stop box, with transition kerbs beyond, to allow the bus to approach and straighten smoothly and dock correctly.

Where kerb heights are changed, carriageway and footpath crossfalls must be considered carefully. Ensure that footpath crossfalls have a gradient of no more than 3% within the clear stand area, as a steep backfill from the kerb is undesirable for customer safety and comfort.

Before increasing kerb height, the layout of each bus stop should be reviewed to ensure that no conflict will occur. Factors to consider include:

- The ground clearance of buses. Although bus stop layouts have been designed to avoid the need for buses to overhang the kerb on arrival or departure, this may occur at particular sites due to, for example, inconsiderate parking. In this case, the kerb should be no higher than the minimum ground clearance of the bus.
- The proximity of driveways. If the bus stop is close to a driveway, this may limit the ability to increase the kerb height. Some bus stops may have to be relocated slightly to facilitate raised kerbs without adversely affecting driveways

3.6.8 Bus stop passenger area

This section contains design guidance on the various components on the pedestrian approaches to the bus stop and within the passenger waiting area.

See figures in Section 3.6.6: *Bus stop types*, for the layout of passenger areas.

3.6.8.1 Hard stand area

A passenger clear stand area with a sealed, smooth surface connects the bus doors with the nearby footpath. This is particularly important for the accessibility of wheelchair users, parents with prams, etc. It also defines the waiting and circulating space around the bus stop area.

The extent of the clear stand area may vary. However, as an absolute minimum, a clear stand area should be provided at each bus stop to align with both front and centre doors of all bus types, to ensure safe access and egress for customers both on foot and in wheelchairs. The access and egress areas should comply with the Standard for New Zealand Design for Access and Mobility – Buildings and Associated Facilities (NZS 4121:2001). A suitable pedestrian connection that complies with NZS 4121:2001 should be provided from the hard stand area to the nearest sealed footpath. To achieve this the minimum acceptable length of clear, hard-surfaced and level area is 9 m measured along the kerb.

Driveways

A driveway is not an acceptable location to drop off or pick up passengers. Dropped kerbs cause a too large gap between the bus door and the ground, which poses as a trip/fall hazard the clear stand area should be away from any vehicle crossing, and the side slopes of any nearby crossing may need to be adjusted for pedestrian accessibility.

Catchpits

The use of catchpits in the hardstand area should be avoided or fitted with a frame to ensure that the ramp, when deployed, is stable and so that passengers will not trip or become trapped in the event they step into the carriageway before stepping onto the bus.

Tactile ground surface indicators

Tactile ground surface indicators (TGSIs) provide visual and sensory information about the road environment. They assist people with vision impairment to access the bus from the adjoining footpath by:

- Warning people of the kerb and potential hazard beyond it. Warning indicators should be installed 600 mm x 600 mm, placed 300 mm back from the front of the kerb edge, adjacent to a bus stop, close to the location of the entry door.
- Directing people from the footpath to the kerb where the bus front door will be and from the bus back to the footpath. Where the warning indicators are not in the direct line of the continuous accessible path of travel, directional indicators of 600 mm wide should be installed to form a continuous path leading to the warning indicators.

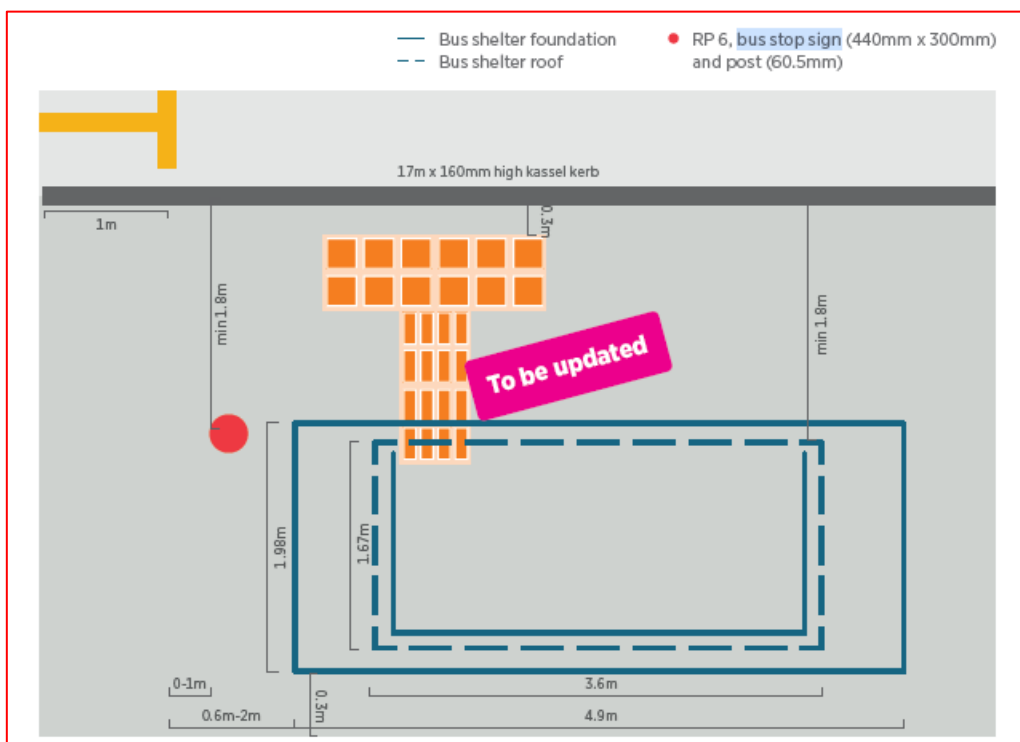

Figure 76: Recommended layout for tactile ground surface indicators at bus stops

For more on tactile ground surface indicators and mobility access, see:

- Section 3.4: *Footpaths and the public realm*
- Road and Traffic Standards (RTS) 14 *Guidelines for facilities for blind and vision-impaired pedestrians* (2008)
- NZS 4121:2001 *New Zealand design for access and mobility: Buildings and associated facilities*.

3.6.9 Bus shelters

Bus stop shelters provide waiting passengers with protection from the sun, wind, and rain. They also define the bus stop area strongly, as bus shelters are the most visible permanent indicator of the presence of a bus service.

The location and configuration of all proposed bus shelters should have to take the surrounding context into account, e.g. boundary conditions, driveways, planting and buildings.

Ideally all inbound bus stops (as defined in Section 3.6.6: *Bus stop types*), with the exception of end-of-route stops or those stops already under canopies, should be provided with a shelter.

It is a priority to provide shelters:

- At bus stops located on a high frequency bus route
- Where customers connect between services
- Where there are generally more than 20 passenger boardings per day.

Even if the above do not apply, shelters must be considered:

- Near retirement or nursing housing with a minimum of 10 daily boardings, and near all new such developments
- Where development means patronage is projected to meet criteria
- Where bus stops are being consolidated and combined patronage justifies shelter provision
- Where the shelter is to be funded and maintained by the private sector
- Where the bus stop is served infrequently. Passengers at these stops tend to arrive slightly earlier which means that passengers wait longer. As a guide, provide shelters where there is a minimum of 15 daily boardings on routes where peak waits are greater than 15 minutes.

Bus shelters do not need to be provided at stops where passengers only use the stop to alight (“outbound” stops).

Bus shelters may also not be required where there are building canopies, although seating should be provided if possible. This should be determined on a case-by-case basis, as at some exposed sites, a building canopy may not give shelter from wind-driven rain.

3.6.9.1 Bus shelter layouts

The bus shelter must be:

- Close to the head of the stop. If this is not possible within the current layout, consider amending or widening the bus stop area or footpath.
- On the footpath, without blocking the main pedestrian through route. Where there is enough width, bus shelters should be located to the back of the footpath, further from the carriageway. The area for the pedestrian through route has to cater for the pedestrian flow along the route and the

potential obstruction caused by waiting passengers. Placing the shelter to the rear of the path enables the remaining width to be made available undivided to pedestrian movement but can require the main flow along the path to weave around the shelter.

- Where space permits, shelters can be placed in front of the main pedestrian movement alignment, so long as the minimum space requirement of 1.5 m between the shelter and the kerb can be achieved.
- Accessible with the necessary clearance and circulation spaces, particularly for people with physical or vision impairments.

Minimum clearances must be maintained; greater clearances are preferred in many situations.

- The kerb zone must be free of fixed obstacles for at least 1000 mm from the kerb face, to allow for potential overhang of a bus and its mirrors on entry and exit
- The boarding and alighting clear area of 1.8 m x 9 m should be free of fixed obstacles
- Maintain a continuous accessible pedestrian through route of 1.8 m for the full length of the bus stop. In very constrained locations, an absolute minimum clearance of 1.5 m is acceptable as an exception and subject to a Departure
- In addition to the above, if the bus shelter backs directly onto a property boundary or fence, the property owner may wish to have a 500 - 600 mm gap between the back of the shelter and the boundary for maintenance access, etc.
- In constrained sites, a minimum of 350 mm should be provided between the property boundary and bus shelter.

Driveways

The placing of bus shelters either side of driveways should consider pedestrian and vehicle visibility splays from driveways. Bus shelters can impact on sight lines of oncoming traffic, especially where bus shelters are to the right of vehicles exiting the driveway.

The appropriate (and feasible) visibility splay for each site must be considered on its own merits. Note that set back from the road carriageway may be more important than the distance from the driveway in determining the ability to see past the shelter.

Power lines

Where a bus shelter must be installed closer than 2.2 m to a power pole or line, prior written consent is required from the line owner.

Three layout options

Three bus shelter layout options have been identified for ideal sites and for constrained roadsides where preferred configurations cannot be achieved. The alternative layouts include offsetting the bus shelter from the head of the stop, a narrower shelter, and a bus boarder with the shelter at the back of the footpath. Each option has advantages and disadvantages to consider when choosing the solution for a particular site.

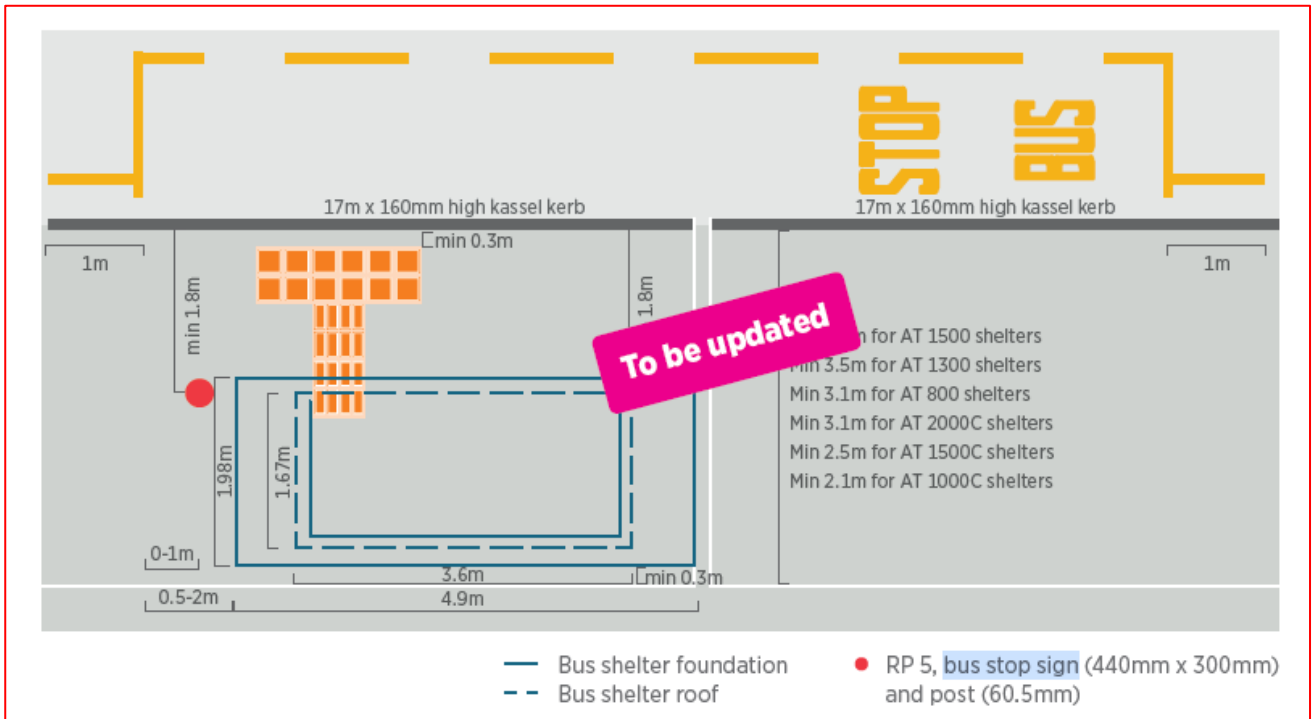

Figure 77: Bus shelter layout 1

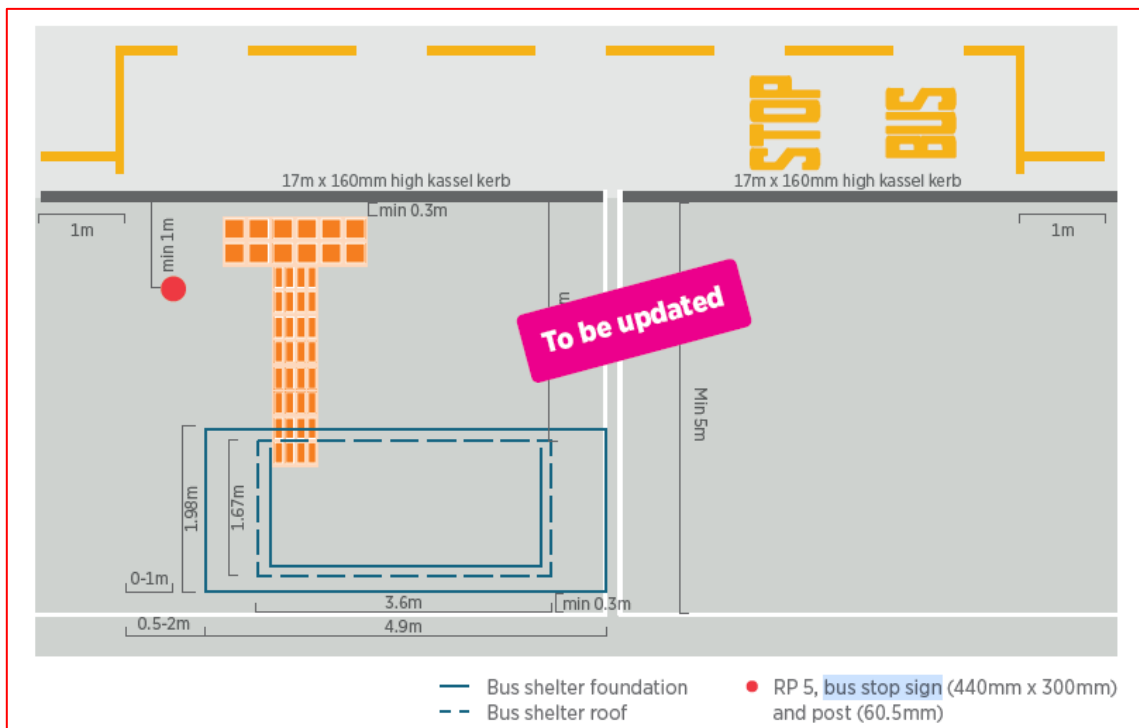

Figure 78: Bus shelter layout 2

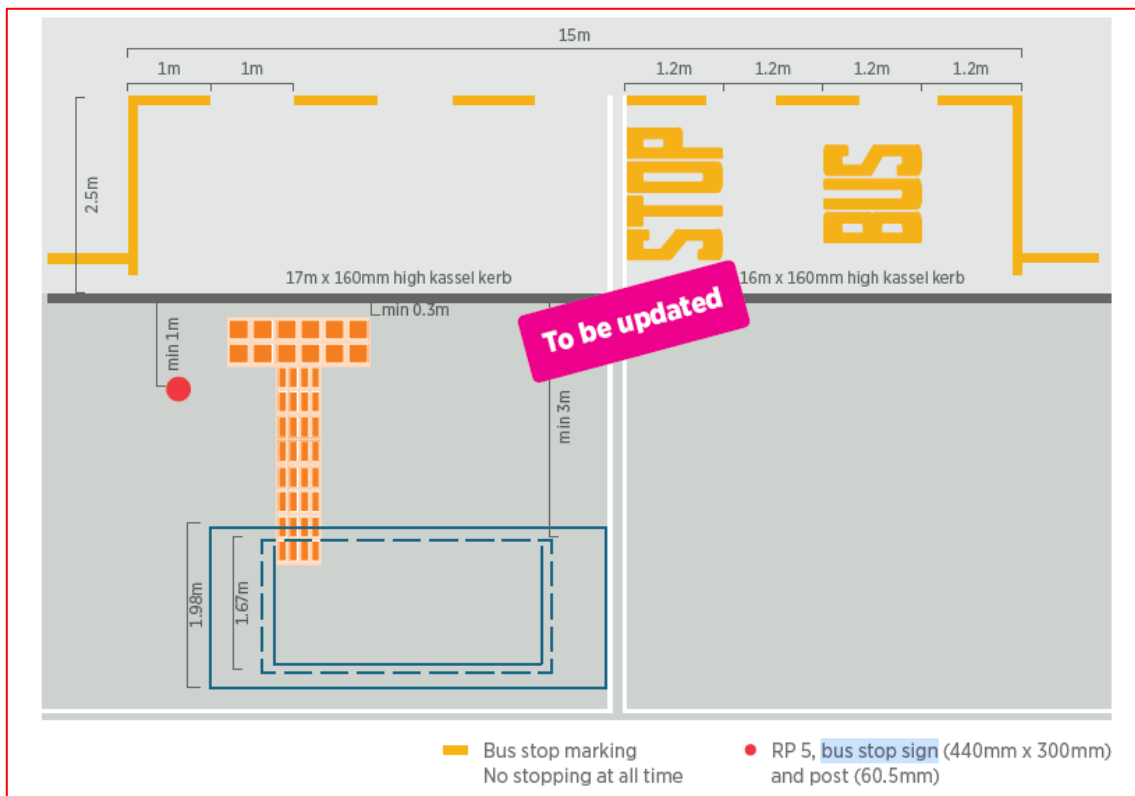

Figure 79: Bus shelter layout 3

Where the constrained dimensions cannot be met, consider:

- Installing a bus boarder to widen the available area
- Repositioning the bus stop to a nearby location with more space
- Using a non-standard shelter with reduced dimensions. Cutting back the end walls of the shelter may accommodate the required clear footpath width. However, also consider the dimensions of the shelter roof and whether it needs to be cut back to provide sufficient kerb clearance
- Reducing the minimum accessible pedestrian route, bearing in mind the respective usage levels of the shelter and the pedestrian route
- Acquiring land to provide additional width.

Non-standard shelter dimensions or a pedestrian route of less than 1500 mm requires approval of Auckland Transport Design & Standards team. The proposal must be submitted with documentation demonstrating that the minimum standards cannot be met and why; and that the options above have all been considered before selection of the scheme proposed.

For more on pedestrian facilities, see:

- Section 3.4: *Footpaths and the public realm*
- NZTA: *Pedestrian planning and design guide*, Section 14.2.2 and Table 14.3 (December 2007).

3.6.9.2 Bus shelter design

AT Metro has procured a new shelter design to form a suite of shelters assembled from modular components. Using this system, a range of shelter sizes are available to suit the space available to specific sites. Three lengths (Minor, Intermediate, Major) and three depths (1500, 1300, 800) are available as standard. Some bespoke designs have been developed from the modular concept for specific sites. A cantilever derivative is also available for use in exceptionally constrained sites.

The modular shelter suite is configurable to use timber, metal or glass panels in different positions. There is a 'standard' layout, but if local circumstances call for it, different panel configurations can be proposed. All non-standard panel layouts must be approved by AT Metro Infrastructure.

The New Network concept will cause a considerable amount of customer interchange to occur between arterial and crosstown routes. At key nodes it is expected that 'neighbourhood interchanges' will be created to facilitate interchange with continuous cover between stops as far as is possible. The AT Metro modular shelter system must be used to promote this connectivity through familiar, recognisable infrastructure linking the stops. Continuity of customer information signing must also be provided.

Any proposal to use a shelter that is not part of the AT Metro modular shelter suite is subject to the approval in advance of AT Metro Infrastructure.

AT Metro should be consulted at first instance to determine the type of bus shelter to be implemented.

Minor shelter

The Minor 1500 shelter is used as the standard type at a typical stop. The Minor 1300 can be used if it is not possible to fit the 1500 safely. AT Metro and Auckland Transport Design & Standards must be consulted before anything smaller is proposed to be installed.



Figure 80: Minor shelter example

Intermediate/major shelter

At stops with high peak boarding demand (e.g. in town centres or outside schools or railway stations) it might be necessary to provide greater capacity; in which case the default shelter will be the Intermediate 1500 or the Major 1500. The same limitations apply to the use of shallower shelters.



Figure 81: Intermediate shelter example

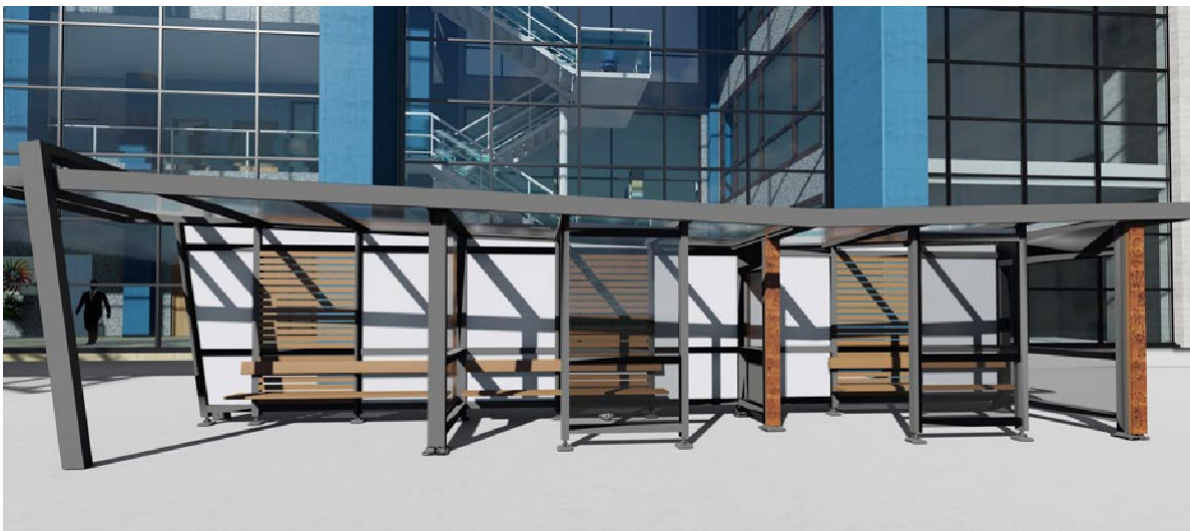

Figure 82: Major shelter example

Glass marking

See Standards New Zealand NZS 4223:2016²² Part 3 (clause 303, page 7) for more detailed guidance on marking glass.

²² *Glazing in buildings – Part 3: Human impact safety requirements*

3.6.9.3 Street furniture

Street furniture such as seats, shelters, rubbish bins and information signs may improve the amenity at a bus stop. To ensure that bus stops make a positive contribution to the streetscape, it is important to ensure that these features are well-designed and do not impede access.

All street furniture at bus stops should be set back from the kerb face by at least 1000 mm to account for bus overhang. Within the road corridor there should be a 500 mm set back from the kerb face. All street furniture should be located to maintain clear boarding and alighting areas, as well as keeping the 1.8 m pedestrian through route clear. Consolidate street furniture as much as possible to maximise a barrier-free space.

Additional seats should be located to be comfortable for passengers, e.g. well back from traffic and allowing good visibility to approaching services. Where footpaths are narrow, seating may be provided in the street furniture zone, at least 1000 mm from the kerb face. In these cases, the seat should face away from the road, for safety.

Street furniture should not obstruct sight lines between approaching buses and waiting passengers.

The amenities at bus stops should ideally be designed as a component of the overall streetscape, e.g. as part of an overall corridor-based enhancement.

Cycle parking should be designed and located so it does not create a hazard, or impede access, for disabled people.



Figure 83: Example cycle parking at bus stops

Street furniture should be easy to maintain and replace, durable and long-lasting. It should also be as resistant as possible to vandalism, without detracting from comfort or its aesthetic impact.

For more on street furniture, see:

- Section 3.4: *Footpaths and the public realm*
- NZTA: *Pedestrian planning and design guide*, Section 14.9 (December 2007).

3.6.10 Landscaping

Natural landscaping may be provided at a bus stop to enhance the bus stop amenity. Key considerations specific to trees and landscaping include:

- No planting should be located in the boarding and alighting areas or in the 1.8 m pedestrian path of travel
- Planting must not obstruct sight lines between approaching buses and waiting passengers. On the approach side of a stop it should be limited to ground cover or low shrubs, less than 0.5 m high
- Use tall, clean-stem shade trees towards the rear boundary of the road reserve with clear access around them. They must not obstruct sight lines
- Trees must not overhang a bus shelter but may provide shade to open standing areas.

Trees must be capable of mature growth that can be easily maintained outside the clearance envelope.

3.6.11 Passenger information

3.6.11.1 Bus stop sign

The bus stop sign (RP-5, in Figure 64) is required by law to be displayed near the head of a bus stop. It identifies the area as a bus stop and prohibits parking. It is an important indicator to passengers and bus drivers and acts as a legal control point for the layout of bus stop facilities.

The RP-5 sign should ideally be placed in a direct line with the head of the bus stop box. It must not be positioned outside the length of the box.

Outside the CBD the RP-5 and bus stop flag (see Section 3.6.5.1: *Bus stop sign*) must be co-mounted on a bus stop-specific pole. Mounting on existing poles is not acceptable. The pole must be installed so that no part of either sign or the pole shall be closer than 1000 mm behind the kerb face. This can be achieved by installing the pole 1000 mm behind the kerb with both signs on the inside of the pole. In order to mount either the RP-5 or the flag between the pole and the kerb, the pole must be installed sufficiently far from the kerb that the sign achieves the 1000 mm clearance. The requirement for a clear walking path will be critical to the positioning of the bus stop pole.



A bus stop information sign, known as a bus stop flag, shows stop-specific information, e.g. the bus stop number, bus stop name, direction of travel, the routes that use that stop. It must be mounted perpendicular to the kerb. Where possible it should be mounted on the same pole as the RP-5, and both signs must be at least 1000 mm inside the kerb face.

At town centres and CBD stops, the information sign may take the form of a double-sided plinth, which must be located with close regard to walking lines along the footpath as well as to and from the doors of a stopped bus.

Figure 84: A bus stop information sign

3.6.11.2 Timetable information

Passengers need to be informed when they can expect the bus they want to use. Current timetable information should always be provided at bus stops, even if the stop also has a real-time information display. Auckland Transport will organise and install customer information at all stops.

Real-Time information signs can be installed as a stand-alone item or integrated within AT Metro standard shelters. Guidance on where to install real time information signs is shown below.

Timetable cases must be mounted on the bus stop pole or within a bus shelter.

At main transfer points, more extensive timetable information should be displayed within the bus shelter.

Guidance on the location, type and placement of signs around customer information signs at bus stops is to be obtained from Auckland Transport.

Electronic public information displays

Electronic public information displays at bus stops are used primarily to give prospective customers current information about the expected arrival times of buses. They can be used also to give public information about other services or facilities in the local area or further afield. It is intended that a self-contained solar-charged EPID is to be installed at every bus stop that does not have a need for a larger LCD unit with permanent power supply.

3.6.12 Bus stop lighting

Lighting at bus stops enhances the security of passengers, improves the perception of personal safety, enhances the bus journey experiences (while waiting, boarding and alighting) and ensures that bus drivers can see waiting customers.

Solar power should be considered where connection to electricity network is not practicable. Auckland Transport's new shelters are all fitted as standard with solar lighting.

To ensure that passengers can access the stop, the surrounding paths to and from the bus stop should also be well lit. The extent that this should be included as part of any bus stop installation or improvement depends on the specific site with decisions to be made by AT Metro.

The appropriate lighting level should be 30-40 lux with a minimum uniformity ratio of 0.5 within the immediate waiting area. Higher lighting levels should be considered where there is a defined need.

Approaches within 15 m of the stop should be lit to 10-15 lux with a minimum uniformity ratio of 0.3. Higher lighting levels should be considered where there is a defined need.

For further guidance on lighting design, refer to:

- Section 3.12: *Street lighting*
- AS/NZS1158: *Lighting for roads and public spaces*

3.6.13 Cycleways at bus stops

The following section provides three designs that can be implemented to ensure cyclists are protected around bus stops, and at bus layovers.

Factors to consider:

- **Bus stop operation and frequency:** The bus stop island design needs to consider bus flows using the stop; such as high frequency bus routes, and where driver changeovers occur. Bus stops with infrequent bus service (fewer than about 10 buses per hour) with sufficient carriageway width may not require the installation of any on-road/off-road cycle lanes and associated bus stop islands.
- **Road network:** Roads that have been identified with focus on cycling should consider cycle lanes behind bus stops, where bus stops are to be installed.
- **Road corridor:** The road corridor width, driveway locations, proximity to intersections, land use (commercial versus residential area) will determine the type of treatment that can be installed.
- **Proximity to intersections:** Given the potential conflict for left turning vehicles in front of cyclists, there needs to be careful consideration when implementing cycle lanes behind bus stops near intersections.
- **Proximity to driveways:** Cycle lanes behind bus stops should not be installed within proximity to driveways (residential areas).
- **Cycle volumes:** Roads with high volumes of cyclists need to consider provision of a safe cycle facility around bus stops.
- **Pedestrian and cycle interaction:** Pedestrians may have to cross separated cycleways to access bus stops, pedestrian crossing facilities, car parking and the footpath. The choice of mitigation measure for these conflicts is a function of how much space is available; ideally people stepping off buses, or out of parked cars should not step directly into a separated cycleway.

3.6.13.1 Design options

The three design options are as follows:

- Option 1 – Full island design
- Option 2 – Partial island design
- Option 3 – Boarding strip.

Full island design

Option 1 is the ideal layout (Figure 85) as bus patrons do not have to cross the cycleway when transitioning between the waiting area and the bus.

A raised cycleway to footpath level reinforces priority to crossing pedestrians, while a lowered cycleway design with drop-down pedestrian ramps shall be considered to give priority to cyclists; the provision of this will be site-specific. In constrained corridors, a shared path could be provided behind the bus stop. However, care should be taken to ensure that adequate width is still provided for this, with adequate path markings.

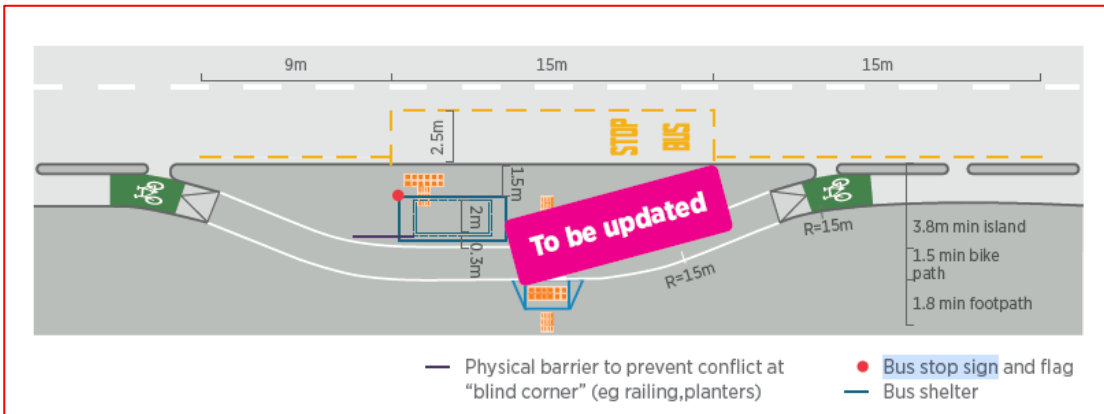

Figure 85: Full island design (Preferred)

Partial island design

Where there is not enough room to achieve a full bus stop island, the entering / exiting area can be separated from the other component, creating a “partial island” between the cycleway and the road (Figure 86)

The island should be wide enough for an entering or departing passenger (possibly with a pram, walker, etc) to stand clear of the cycleway next to the bus. Care must be taken to ensure any design does not limit full accessible boarding.

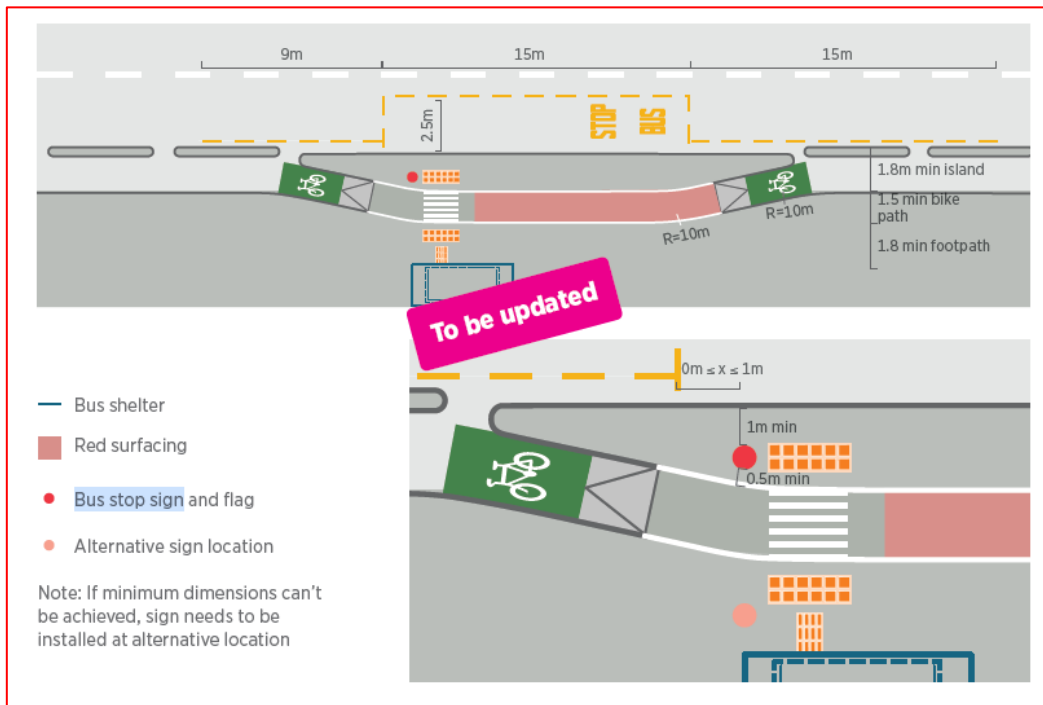

Figure 86: Partial island design

Boarding strip

In scenarios where it may not be possible to provide an island between the cycleway and the road. Bus patrons will therefore have to enter and exit the bus directly from / to the cycleway (Figure 87).

Option 3 should only be considered if there are geometric constraints to achieving the full island/partial bus stop island. This treatment should be implemented with caution, particularly on roads with frequent buses and / or high volumes of cyclists. This option will create conflict between left turning buses at intersections/junctions where the cyclist might approach alongside the bus. Quality of services for buses will be limited with significant volumes of cyclists and potentially creates accessibility issues for wheelchair users. This option should not be used for a bi-directional cycleway, due to the increased safety concerns with the additional conflict points created. This option should not be implemented if the bus stop has high dwell times.

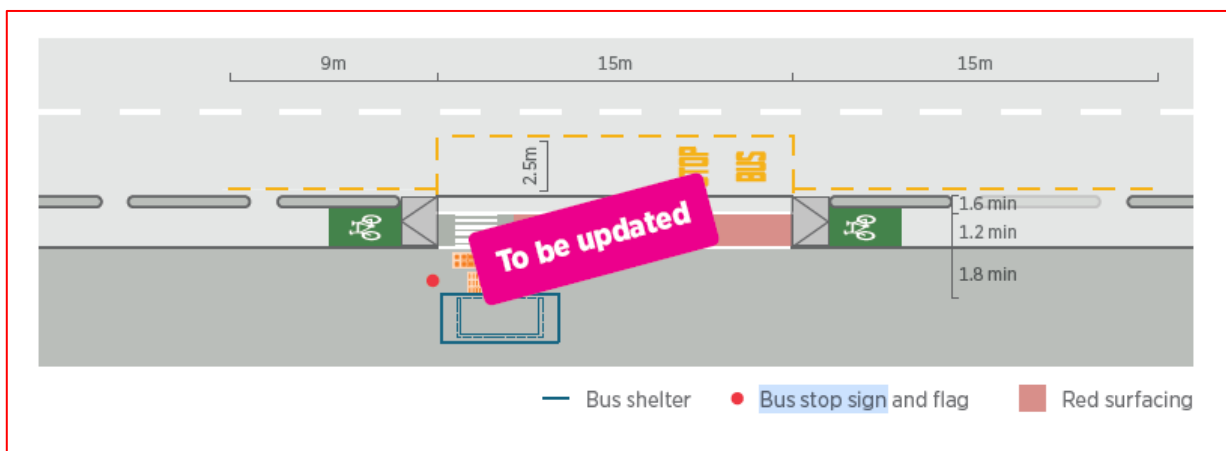

Figure 87: Boarding strip design

For all other elements at bus stops such as around accessibility, additional signs and road markings, safety and security, street furniture, stop specific information and enhancements refer to Table 38: Infrastructure provision for different bus stop types in Section 3.6.7: *Bus stop elements*.

For more on design for people on bikes, see: Section 3.5: *Cycling and infrastructure*.

3.7 Traffic calming

3.7.1 Use of traffic calming devices

Traffic calming devices are means to promote road user safety by limiting speed and diverting traffic. Devices include speed humps, road narrowing, signage and other measures. They may also provide additional landscaping opportunities on the road space reclaimed by the devices.

All traffic calming devices must be approved by a resolution of Auckland Transport's Traffic Control Committee.

3.7.2 Planning the use of traffic calming

3.7.2.1 Advantages and disadvantages

When deciding whether to use traffic calming devices, it is important to consider the potential advantages and disadvantages.

Potential advantages	Potential disadvantages
<ul style="list-style-type: none"> • Better safety for road users, including pedestrians and cyclists • Fewer and less serious vehicle crashes • Reduced speed • Less commercial traffic and "rat runs", i.e. commuters taking fast short-cuts • Less heavy vehicle usage • Less noise • Less need for traffic enforcement • Improved street appeal through planting, furniture and reclaiming parts of the carriageway • Increased driver awareness that this is a local street, and they should adjust their driving accordingly. 	<ul style="list-style-type: none"> • Longer travel time for local residents • More noise from the acceleration and deceleration of larger vehicles • Increased fuel consumption and exhaust emissions from changing speed • Grounding of vehicles and potential damage, especially if devices are constructed incorrectly • An uncomfortable ride, particularly for bus passengers • Loss of kerbside parking space • Constrained access to nearby properties • Slower emergency service response time (Always consider this if the proposed works are on an emergency route.) • Resistance from residents • Shifting traffic problems to adjacent streets • Longer traffic queues • Difficulty for cyclists • High implementation and maintenance costs.

3.7.2.2 Speed environment and purpose of traffic calming

For residential areas it is desirable that residents should have not more than 1500 m to travel at up to 30 km/h to reach higher- order roads with 40 or 50 km/h operating speed.

For collector and arterial roads, the target operating speed may be 30, 40 or 50 km/h with preference for low speed in high-pedestrian use areas.

3.7.2.3 Width of road

A decrease in width of road from 8 m to 6 m is likely to reduce operating speed on a local road with some parking from 45 to 35 km/h with a maximum forward visibility of about 100 m.

Road width should not exceed 6.0 m for local roads in residential areas, to minimise the additional design measures required.

3.7.2.4 Forward visibility

The following charts demonstrate the effect forward visibility and seal width to speed:

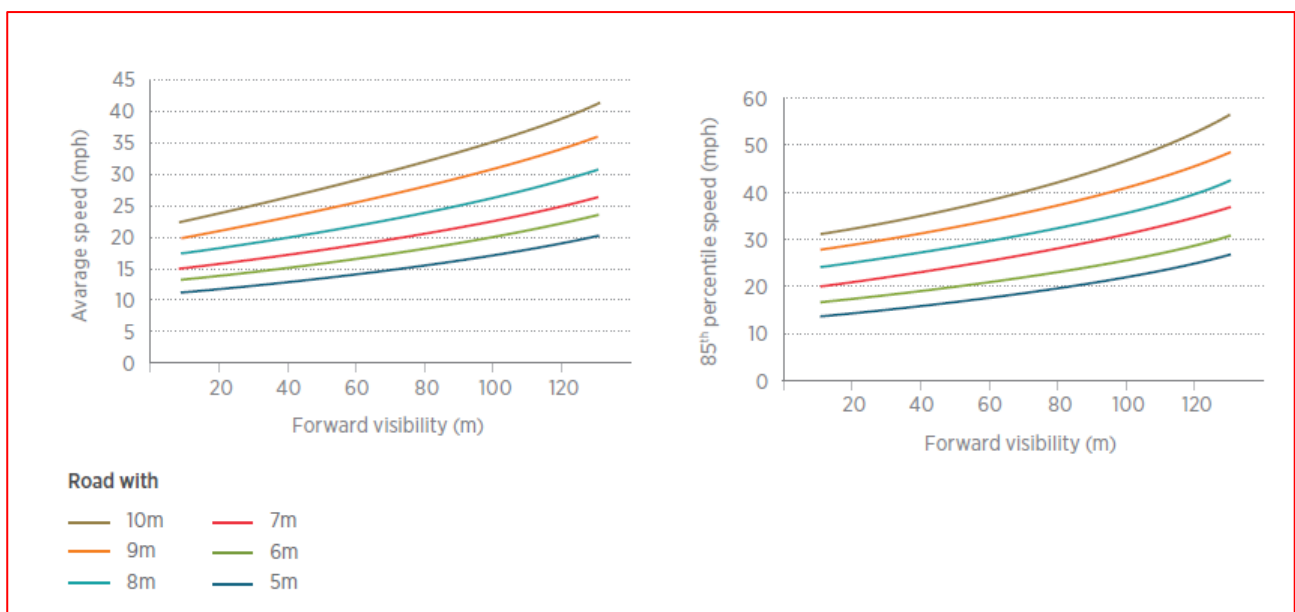

Figure 88: Correlation between visibility and carriageway width and vehicle speeds

From UK department of Transport 'Manual for Streets' Figure 01 and 'TRL661 – *The manual for streets evidence and research*'.

3.7.2.5 Selection of devices

It is only through careful selection, combination and placement of devices that traffic calming is effective. Traffic calming can be implemented using three different types of control:

- Vertical deflection - see Section 3.7.4: *Horizontal and calming devices*
- Horizontal deflection - see Section 3.7.5: *Volume reduction devices*
- Road markings/signage - see Section 3.7.6: *Signs and visual effects*.

3.7.2.6 Calming effect of bends

A bend which changes direction at least 70° with inside kerb radius not exceeding 26 m can be considered as a calming device for all speed environments.

Research in UK by TRL showed the following reductions in speed at bends, where v = approach speed (km/h), R = bend radius (m).

Table 39: Percentage speed reduction due to bend

V^2/R	From 50%ile speed	From 85%ile speed
20	3.5	5
28	5	7
40	7	10
56	10	14
80	14	20

3.7.2.7 Spacing of devices

The spacing of devices should be fit for purpose. Effective spacing usually ranges from 60 m to 120 m intervals.

3.7.2.8 Design Option 1: Speed based design

It is recommended that all traffic calming, and area traffic calming in particular, should follow the principles of speed based design set out in Austroads *Guide to traffic management, Part 8: Local street management*.

3.7.2.9 Design Option 2: Acceptable solution

For simple road design, it may be sufficient to follow the maximum spacing guidance set out in the table below. This solution only applies to roads not more than 6.0 m wide for 30 or 40 km/h and not more than 7.0 m wide for 50 km/h.

Table 40: Maximum spacing of devices for speed environments

Type	Device	Spacing for 30 km/h (m)	Spacing for 40 km/h (m)	Spacing for 50 km/h (m)	Notes
Vertical	Speed humps (sinusoidal)	60	120	(2)	
	Raised tables	60	120	120 (3)	
	Raised Intersection	60	100	120 (3)	
Horizontal	Build-outs or side islands	(1)	(1)	40	
	Chicane (one lane raised)	100	120	(2)	When device design speed is at least 5 km/h below speed environment
	Chicane(one lane flush)	60	100	120	
	Chicane (two lane)	(1)	80	120	
	Traffic islands	(1)	(1)	120	
	Roundabouts	100 (4)	120 (4)	120 (4)	Distances only apply where roundabout operating speed is at least 10 km/h below speed environment on approach

Notes: Spacing applies to distance from another calming device. Where different devices have different spacing for the same speed environment, spacing should not exceed the average of the two distances.

Device not effective for this speed environment unless combined with other devices

Device not suitable for higher operating speeds

Using 1:20 ramps

For roundabouts only, spacing is to any adjoining device, as roundabouts have a greater zone of influence.

3.7.3 Vertical traffic calming devices

Vertical calming devices change the height of a part of the carriageway to compel drivers to reduce their speed.

Vertical traffic calming is particularly suited to narrower streets, typically those with carriageways less than 10 m in width kerb-to-kerb. The calming devices should typically be no closer than 10 m to an intersection and not be within 1 m of a driveway.

The reflective road marking must have anti-skid properties and be of a suitable hardwearing material.

Table 41: Vertical traffic calming device design standards for non-bus routes

Route	Device type	Maximum ramp approach gradient	Maximum height (mm)	Minimum length (m)	Notes
	Speed cushions	1:8 (1:5 side)	75	3.0	Cushion width:1.9 m
No bus service	Raised tables	1:15 or 1:10	75 or 100	4.0	Gap between cushions: 0.75 m
	Speed humps (sinusoidal)	-	100	3.7	
	One-way (Swedish) tables	1:10 approach 1:40 exit	100	2.0	Gap cushion to kerb: 1.0 m desirable, 1.1 m maximum

3.7.3.1 Speed humps

Speed humps should be installed at right angles to the path travelled by vehicles. They are generally sinusoidal in shape, 100 mm in height and must have a longitudinal length of 3.7 m and spaced fit for purpose, typically not more than 80 m apart.

Speed humps should be constructed as shown on Plan TC0001.

3.7.3.2 Raised tables

Raised tables have a level surface that is easier for larger vehicles to negotiate and for pedestrians to cross at.

Intersection table

Corner curves should be reduced to their minimum, to enable pedestrian crossing points to be kept close to the intersection. Corners should be clearly defined, with at least 65 mm high kerb except at kerb crossings to guide pedestrians. Traffic lanes flush with footpath should not be used unless pedestrian priority and tactile indication of safe pedestrian routes is provided. Bollards may aid traffic guidance and footpath protection.

Width should be not more than one traffic lane in each direction.

Size – Mid-block

The flat area of the raised table is generally 4 m, or 6 m to allow larger vehicles to negotiate the device more easily and create less discomfort for those on board.

Gradients

The maximum ramp gradient allowed on any road is 1:10.

Alignment

Ramps must be aligned at right angles to vehicle paths as far as practicable.

One-way tables

One-way (Swedish) tables can be used on one-way traffic lanes. The height is normally 100 mm.

The approach ramp is 1.0 m long (1:10 grade), or 2.0 m (1:20 grade) for bus routes.

The table top can be reduced to 2.0 m minimum, but usually not less than 3.0 m where pedestrians cross.

The departure ramp is normally 4.0 m long, or the road surface may continue flush with the table top on the departure side.

Buses

The length of the flat section should be a minimum of 6 m. Ramp Gradient should be 1:20, and height of table should be 75 mm.

Construction

Speed tables should be constructed as shown in Plans TC0003, TC0004 or TC0023. 25 MPa concrete with mesh reinforcement requires time to harden before traffic is introduced. 50 MPa concrete with fibre reinforcement can harden sufficiently for traffic in a much shorter time.

One-way tables

One-way (Swedish) tables can be used on one-way traffic lanes, This type of ramp is suitable for roundabout entries and exits.

- The height is normally 100 mm
- The approach ramp is 1.0 m long (1:10 grade)
- The table top can be reduced to 2.0 m minimum, but usually not less than 3.0 m where pedestrians cross
- The departure ramp is normally 4.0 m long (1:40 grade), or the road surface may continue flush with the table top on the departure side, with a grade difference not more than 1:40 from the approach grade.

RTS 14

All tactile ground surface indicators should be laid out as outlined in NZTA RTS14¹⁰.

3.7.3.3 Speed cushions

The maximum height of a speed cushion is 75 mm with an optimum width of 1.9 m - 2.0 m and a gradient of 1:8 at the leading and trailing ramps. Side ramps should be 1:5 ramp. The gap between cushion and kerb and between adjacent cushions should ideally be 1.0 m, and no less than 750 mm.

If a single cushion is used in a single lane section of road, the gap between kerb and cushion must be 750 – 1000 mm on each side.

Speed cushions should be constructed using:

- Pre-made rubber cushions bolted into the road surface (see Auckland Transport TDM SED TC0006) or
- Asphaltic concrete or concrete. (See Auckland Transport TDM SEC TC0007.)

3.7.4 Horizontal traffic calming devices

These devices refer to the horizontal realignment of the kerb line over a short length of road.

Cycles

Should a narrowing of the carriageway be required, with design speed greater than 30 km/h, a minimum clearance of 4.2 m kerb-to-kerb should remain.

When horizontal devices are used in low-traffic residential local roads in 30 km/h speed environment, 3.0 m kerb-to-kerb width may be appropriate.

3.7.4.1 Road-narrowings (including build-outs and chicanes)

Build-outs or side islands

Build-outs or side islands are usually placed opposite each other, with give-way signage on the approach that does not have priority.

Cycles: If the remaining lane width cannot be at least 4.2 m wide, it is advisable to provide a gap along the original kerb line to allow cyclists to bypass the build-outs on high-traffic roads. This is discretionary on local streets or roads with a low number of vehicles per day and low speed (<30 km/h).

Auckland Transport TDM SED IS0003, IS0004 and IS0005 show typical planted side islands and details.

Chicanes

Chicanes follow a similar principle to build-outs, but they differ by being staggered on opposite sides of the road, rather than being directly opposite each other.

3.7.4.2 Traffic islands

Mid-block traffic islands can be used as part of a physical narrowing of the road by reducing the available carriageway.

Cycles

If the distance between the kerb and the traffic island is between 3.2 m and 4.1 m, this can be detrimental to cyclists, as it is too narrow for a vehicle to safely overtake cyclists.

Where the lane width is less than 3.2 m, a cycle bypass should be considered. A lane width of 4.2 m or greater provides sufficient space to allow vehicles to overtake cyclists.

3.7.4.3 Roundabouts

While roundabouts are general traffic management tools at intersections, they can also be a useful traffic calming tool when used with single-lane entries and exits to and from the circulatory path.

The ideal design for a traffic calming roundabout is one that requires vehicles to slow down to 25 km/h or below to cross safely.

For further details on the design of roundabouts, see Section 3.3: *Urban and rural roadway design*.

3.7.4.4 Intersection modifications

Kerblines at corners

Reducing speeds at an intersection can be achieved by changing the kerb corners to a tighter layout.

Splitter island

The installation of a splitter island on the approach arms could narrow the intersection. However, entry and exit lanes may need to be wider for large vehicles to turn, so splitter islands are rarely preferable to tight corner kerblines.

Entry threshold

Where there is significant pedestrian activity, a raised table entry threshold may be used. A speed environment of 50 km/h or less is likely to be necessary for a busy pedestrian street.

The toe of the ramp may maintain the line of the major road kerblines or be set back so that the top of the ramp is 2 – 6 m from the major road kerblines.

Where pedestrian activity is low, a flush entry threshold with colour or paving difference may be more appropriate, with a calming feature between 6 and 40 m from the intersection continuity line.

See Auckland Transport TDM SED TC0030 for an example layout.

3.7.5 Volume reduction devices

6.1 Diagonal diverter

A diagonal diverter breaks a standard four-way intersection into two opposing left or right-turn corners.

3.7.5.1 Median barrier

This limits vehicle entry to a street by eliminating right turns from the through street.

3.7.5.2 Vehicle road closure (cul-de-sac)

This treatment is appropriate on new roads and may be used on roads not yet vested as public road. A stopping-up order is currently required for vested public roads.

Where space is available and the street network is sufficient, forming a cul-de-sac is the most effective solution at reducing motor vehicle traffic volumes along the street. Paths for people on foot or bike provide access for them. Additionally, a cul-de-sac can be planted to improve the amenity of the street. They are typically placed on minor streets at an intersection with a major street, to manage motor vehicle volumes on the minor street. This treatment may also be used to reduce the number of intersections on an arterial road for safety and efficiency. A closure may enable a pedestrian or cycle crossing to be installed on the major road to serve a significant desire line, or a bus stop.

- Special consideration should be given to service vehicles to allow them to turn around in the turning head provided
- Where the street block is very short, and property access allows waste collection from other street frontages, a turning head may not be necessary
- Provides good opportunity for landscaping. Native and low-maintenance plants are recommended.

3.7.5.3 Half road closure

Remove through traffic in one direction from a street by closing off either the inbound or the outbound lane at an intersection. A traffic island is placed near the centreline with a gap between the island and kerb extension to permit bicycle access.

3.7.5.4 Driveway link

Driveway links take the form of a single-lane two-way meandering road extending over the length of two or more property frontages.

The resulting traffic volume should be low (not more than 1000 vehicles per day) otherwise congestion and crash risk may increase.

3.7.6 Signs and visual effects

3.7.6.1 Signs

Speed hump and raised table signs

Any vertical deflection device needs to be easily identifiable by the reflective marking on the device and with preceding signs that are visible to oncoming drivers.

The NZ Transport Agency Traffic Control Devices Manual states that the sign PW-39 (hump sign) should be used on the approach to each device and placed approximately 60 m from the device for driver visibility. When the PW-39 sign is used, it must also be used with the PW-25 (advisory speed) sign to indicate the recommended speed limit for negotiating the device. No other signs may be placed on the sign pole with the PW-39 and PW-25 signs.

Give-way signs and markings at single-lane narrowings

Give-way signs and markings should always be installed at single-lane two-way features where peak traffic flow is significant or where speed environment exceeds 30 km/h.

Signs at roundabouts

Clause 10.4(2) of the TCD Rule states that “If a single lane roundabout has safe and appropriate engineering measures installed to slow vehicles and the measured mean operating speeds on the approaches to and through the roundabout are 30 km/h or less, the roundabout may operate without signs, signals and road markings described in Clause 10.4(1)”.

Signs and markings should only be omitted:

- If a roundabout is within a 30 km/h speed environment
- Peak traffic flows are low
- The roundabout is clearly visible, and
- There is low risk of abuse by right-turning vehicles.

3.7.6.2 Visual narrowings

Traffic calming a road can be combined with other techniques to create a visual perception of a narrow, multi-use carriageway. It is important that visibility for pedestrians and cyclists is still maintained after any treatment.

See Section 3.4: *Footpaths and the public realm*, for planting for use in local area traffic management.

3.7.7 Entry/gateway treatments

At the beginning of all traffic calmed or slow-speed zones, an entry or gateway treatment should be applied to indicate that the area is calmed and that drivers must proceed with more caution and at a slower speed.

3.7.8 Traffic calming on bus routes

Bus services operate to a timetable. An accumulation of traffic calming devices can lead to excessively increased journey times for buses.

- Bus operators prefer horizontal deflection measures
- Where horizontal measures cannot be used, One-way (Swedish) tables are preferred on bus routes
- Speed cushions may be used in conjunction with other horizontal features
- Speed cushions should be no higher than 75 mm. However, raised tables are acceptable on a bus route that passes through a town centre, a low-speed school zone or other areas of recognised high pedestrian frequency. In these instances, ramp gradients should not be steeper than 1:20 and table heights should not exceed 75 mm.

Table 42: Vertical traffic calming device design standards for bus routes

Route	Device type	Max ramp approach gradient	Max height (mm)	Min length (m)	Notes
Rapid Transit Network	None (speed cushions only in exceptional situations)	-	-	-	Typically not permitted (see speed cushion design standards below)
Frequent Transit Network	One Way (Swedish) tables	1:10 (1:40 departure)	100	3.0 (1)	
	Raised Table	1:10	100	6	
	Raised Table	1:15	75	6	Can only be used if a Departure from Standard has been approved.
	Speed cushions	1:8 (1:5 side)	75	3.0	Cushion width =1.9 m Gap between cushions = 0.75 m Kerb to cushion gap = 1.0 m desirable Kerb to cushion gap = 1.1 m max
Bus routes through low-speed zones	Raised tables ¹	1:10	75	6.0	Town centres Outside schools High pedestrian frequency areas (intersections, mid-block & pedestrian crossings)

3.8 Parking and design

The demand for parking is driven by land use. The AUP sets parking requirements in relation to land use, e.g. the number of parking spaces to be provided for particular land uses or areas. The plan also includes a design table of parking space and manoeuvring dimensions.

Auckland Transport provides public on street parking within the road reserve and is also responsible for the design, construction and management of some public off street parking facilities.

3.8.1 Design philosophy

A table of basic parking dimensions suitable for on street parking and small to medium at grade open air off-street parking is provided below. The dimensions in this table are suitable for medium to high turnover parking by casual users, e.g. retail sites, commercial sites and community facilities.

The Auckland Transport 85th percentile car shall be used for all tracking. The 95th percentile car shall be used as the check vehicle.

Both design and check vehicles should be tracked at a maximum speed of 5 km/h.

Table 43: Parking space and manoeuvring dimensions in metres

Parking angle	Width of bay	Parking space depth ¹	Wheel stop distance from kerb ²	Traffic / aisle buffer ³	Manoeuvring space
90°	2.5	5	0.5	1	5.2
	2.6		0.5	1	4.6
	2.7		0.5	1	4.3
75°	2.5	5.2	0.5	1	4.1
	2.6		0.5	1	3.6
	2.7		0.5	1	3.2
60°	2.5	5.2	0.5	0.8	3.3
	2.6		0.5	0.8	3.1
	2.7		0.5	0.8	2.8
45°	2.5	5	0.5	0.5	2.5
	2.6		0.5	0.5	2.5
	2.7		0.5	0.5	2.5
30°	2.5	4	0.5	0.5	2.5
	2.6		0.5	0.5	2.5
	2.7		0.5	0.5	2.5
0°	6	2.1			3.7

Notes:

1. Parking Depth is measured perpendicular to the face of kerb, add 0.5m when measured from the face of a well unless wheel stops are provided.
2. Wheel stops should only be provided where there is insufficient space within the footpath to accommodate the vehicle overhang and maintain the clear pedestrian through route. Wheel stop placement is included in the parking depth space
3. Traffic/aisle buffer is for separation from moving traffic and could be wider if used as a walking route in a car park.

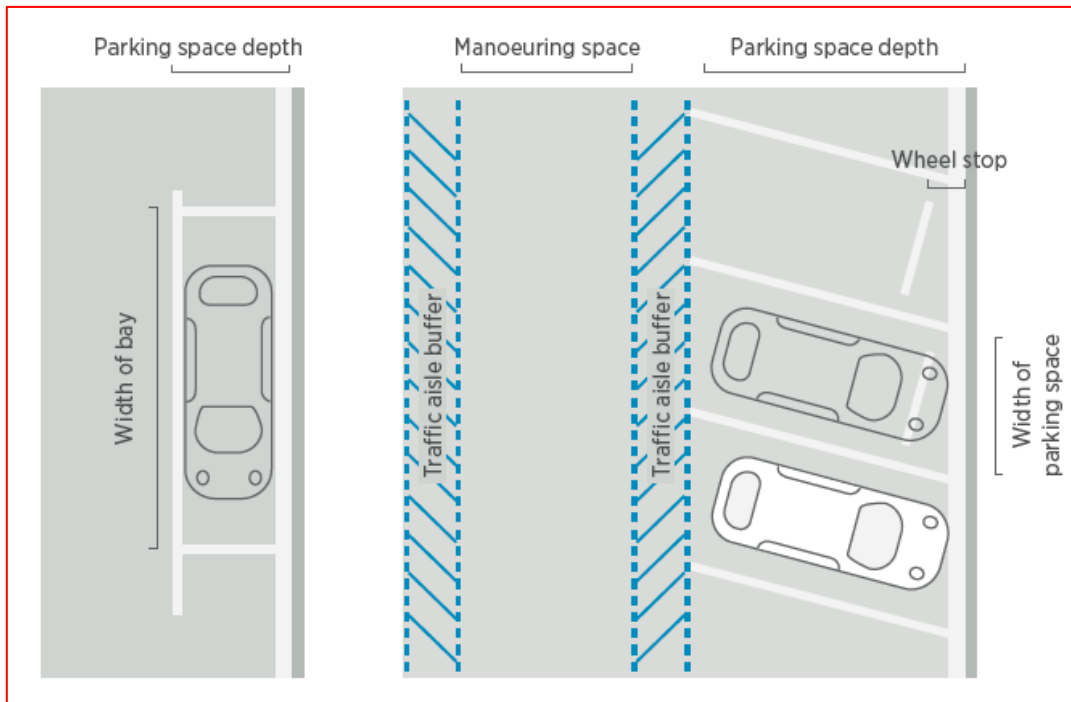

Figure 89: Car parking layout

3.8.2 Mobility parking

The minimum number of mobility spaces required, and the geometric standards for mobility car parking and access are prescribed by the New Zealand Building Code D1²³ and NZS 4121²⁴.

3.8.3 Motorcycle parking

Typical dimensions for motorcycle spaces are 2.5 m long by 1.2 m wide.

²³ Safety of entry/exit to the building and the safety of any internal or external stairs

²⁴ Design for access and mobility

3.8.4 Cycle parking

For cycle parking design and requirements, see Section 3.5: *Cycling infrastructure*.

3.8.5 Loading zones

Typical dimensions for various types of trucks are shown in the table below.

Table 44: Typical dimensions for trucks

Truck type	Length	Zone width
Small rigid	6.4 m	3.0 m
Medium rigid	8.8 m	3.0 m
Large rigid	13.5 m	3.0 m
Articulated	18-20 m	3.5 m

3.8.6 Special parking

Certain locations may have demand for parking by larger vehicles. The typical parking dimension for a car towing a trailer is 12.5 m long and 2.5 m wide, although this can vary significantly with the size of the trailer.

3.9 Pavement and surfacing

A new Engineering Design Code – Pavement Design is in development. It is recommended that designers should discuss their pavement design with Auckland Transport Chief Engineer Group until the Engineering Design Code is published.

Until it is withdrawn on amendment of this Section, Auckland Transport: COP Chapter 16: *Road pavements and surfacing* remains in effect within this Auckland Council Code of Practice.

3.10 Geotechnical and structural design

A new Engineering Design Code – Geotechnical and structural design is in development.

Until it is withdrawn on amendment of this Section, Auckland Transport: COP Chapter 15 *Earthworks* and Chapter 18: *Structures*, remain in effect within this Auckland Council Code of Practice.

3.11 Road drainage

This section gives guidance for the design of drainage in the road reserve.

Terminology

- Road refers to the legal road, i.e. from boundary to boundary, as defined in the AUP.
- Water Sensitive Design (WSD) has been renamed “Integrated Stormwater Management” (or ISM) in the AUP, however WSD is still used and referred to in many associated guidelines and documents
- Other terms are defined in the Auckland Council Guideline Document: *Stormwater management devices in the Auckland region*, GD2017/001
- Storm characteristics for design are generally expressed as the % AEP (Annual Exceedance Probability) or the ARI (Annual Return Interval). In this manual, % AEP is used, to underline the risk management basis of drainage design.

Run-off calculations

Road surface run-off calculations are required for:

- All arterial and collector roads
- Roads with channel gradients outside the range 1.5-10%
- Roads drained to stormwater treatment systems
- Roadways of more than 8 m wide that fall to a channel.

Compliance

Auckland Transport manages the road assets for Auckland as an Auckland Council Controlled Organisation. Except where stated otherwise in this manual, road drainage design must comply with:

- Local Government Act (1974 and more recent updates)
- The Auckland Code of Practice for Land Development and Subdivision
- Auckland Transport: Transport Design Manual
- The Resource Management Act (1991)
- Consent conditions and the AUP rules
- Permitted activity rules imposed by the AUP
- Stormwater Bylaw, Auckland Council, 2015
- Guideline documents.

Standard engineering details and design tool box

The tools and details published by Auckland Transport in the Engineering Design Code should be used for design and detailing. Other design tools and drawings provided by suppliers of products and systems may be used, subject to approval by Auckland Transport Chief Engineer

Information sources

Before designing road drainage, the following design documents and guidelines should be read:

- Auckland Transport's *Transport design manual engineering design code* – Road drainage and surface water control
- Auckland Transport *Bioretention design guide*, 2021²⁵
- Auckland Transport *Swale design guide*, 2021²⁵
- Auckland Transport *Bioretention planting guide*, 2021²⁵
- Other sections of Auckland Transport's *Transport design manual* (TDM)
- *Water sensitive design for stormwater*, Auckland Council Guideline Document GD2015/004
- Auckland Council *Stormwater code of practice* (AC SW CoP)
- *Stormwater management devices in the Auckland region*, Auckland Council Guideline Document GD2017/001
- Auckland Council CoP for *Land development and subdivision*, Chapter 7, 2016
- Watercare Services *Wastewater code of practice* (WSL WW COP), where required in combined sewer catchments
- Austroads *Guide to Road design* Part 5, Part 5A and Part 5B
- TR2013 040 *Stormwater disposal via soakage in the Auckland region*, Auckland Council, 2013
- TR2009/084 *Fish passage in the Auckland region*, Auckland Regional Council, 2009
- *Coastal inundation by storm-tides and waves in the Auckland region*, Auckland Council technical report, TR2016/017
- Ministry for the Environment *Coastal hazards and climate change*, , 2017
- AP-R481-15 *Safety Provisions for floodways over Roads* (Austroads, 2015)
- *Floodplain development manual* (NSW Government, 2005).

3.11.1 Design principles

3.11.1.1 Water Sensitive Design or Integrated Stormwater Management

Auckland Transport strongly supports the use of Water Sensitive Design (WSD). This approach is clearly defined and explained in detail in the guidance document *Water sensitive design for stormwater*, GD04.

The principles for water sensitive design in the road reserve include:

- Road layouts should be designed to retain existing landforms and drainage patterns where possible
- The impervious surface ratio should be kept as low as possible

²⁵ Currently awaiting publication, but can be obtained from Auckland Transport, Design and Standards

- Stormwater management systems and treatment suites should reflect natural water management systems as far as possible
- Earthworks and soil compaction should be minimised
- At all times it should be discouraged to use the carriageway for the conveyancing of runoff.

3.11.1.2 Integration of drainage

Environment

Following WSD principles, road drainage management should be integrated with that of the surrounding area. Greenfield developments should consider intensified or clustered development to minimise land disturbance and earthworks, to protect and enhance the natural environment.

Plans and consents

Treatment should fit with stormwater management plans (SMP) or network discharge consents (NDC) where these are in place, or with the requirements of a resource consent for stormwater discharge.

Catchment planning

Consult with Auckland Council Healthy Waters early on if:

- Existing road run-off is managed under a network discharge consent and an alteration in road drainage is proposed
- A new connection increases the peak flow to an existing drainage network that discharges in to the public stormwater network
- New road design or improvement to an existing road is proposed that is not covered by an existing current discharge consent
- Where substantial upstream or downstream flooding has been identified
- A Stormwater or Catchment Management Plan exists that identifies issues relevant to road design.

Auckland Council Healthy Waters can be contacted at: HWdevelopment@aucklandcouncil.govt.nz

Connecting private drainage

Where approval is sought to connect private drainage discharge to an existing Auckland Transport road drainage asset (e.g. pipeline, manhole or treatment device), the Auckland Transport asset will have to be vested as an Auckland Council public drain asset. The condition of the asset must be investigated. The applicant may have to bear the cost of the investigation, as well as any reasonable cost of bringing the asset to an acceptable condition.

Where a pipeline to be vested as public drain is located in private land in a front or side yard, provision should be made to connect road drainage from the road reserve boundary in future.

Adjoining land

The catchment of run-off from land next to roads must always be considered. Flood hazard management requires that roads be integrated with land upstream and downstream, as set out in Auckland Council's *Stormwater code of practice*. The capacity of primary drainage of developed land may be exceeded in events less than 10% AEP due to blockage or where the existing network has been constructed to have a lower capacity. Probable catchment run-off needs to be calculated in accordance with the Code of Practice for road drainage design.

Kerb discharges

Discharge of water from private land to the road surface is managed by Auckland Transport under Section 357(1) of the Local Government Act 1974. Any proposal to create a new discharge or to alter the flow rate of an existing approved discharge must be made through Auckland Council Regulatory for review and determination by Auckland Transport and must comply with conditions set by Auckland Transport.

Public reticulation

Where there is a new connection or increased discharge to an existing connection, the effects of road stormwater discharge into public reticulation have to be investigated. Integration of peak flow discharges and times of concentration may be able to provide capacity management on the network.

Special areas

In certain areas, the ground conditions require stormwater drainage to meet specific policies or code conditions. These include:

- Combined sewer reticulation
- Soakage discharge
- Groundwater recharge.

Design considerations

Road drainage infrastructure design must show consideration of all of these factors:

- Safety and effectiveness
- Environmental outcomes
- Whole-of-life cost (capital and operational).

3.11.1.3 Tiered objectives for stormwater management design in road reserves

Environmental management design

Environmental management design typically caters for 90th/95th percentile 24-hr of rainfall as given in Auckland Council Stormwater Guidelines.

Serviceability management design

Serviceability management design typically caters for rainfall up to the 10% AEP design storm but varies for different road users.

Rainfall intensity and depth should be obtained according to the methods defined in Auckland Council's *Stormwater Code of Practice*, making use of TP108²⁶ (an earlier document published by the Auckland Regional Council) and applying current allowance for climate change. An example showing the process can be found in the section on swale design in Auckland Council's *Stormwater management devices in the Auckland region* guideline document (GD01)

Serviceability criteria in Tables 41 and 42 should be met. Design objectives should be determined from the safety and service requirements set out in Austroads *Guide to Road Design Part 5A*.

Table 45: Serviceability (10% AEP) allowable spread widths and channel flows – Traffic lanes

Number of traffic lanes in any one direction	Speed environment	
	>70 km/h	≤ 70 km/h
1	1.0 m	0.75 m
2+	1.5 m	1.25 m

Table 46: Serviceability (10% AEP) allowable spread widths and channel flows – Road types

Situation	Requirement
Arterials with sealed shoulder	<ul style="list-style-type: none"> Surface flows should be confined to the shoulders.
Collector and local roads	<ul style="list-style-type: none"> At least one lane each way on collector roads, and at least one lane width on local roads should be trafficable during a 10% AEP storm.
Arterials	<ul style="list-style-type: none"> There should be no need to change lanes during the design storm. Where traffic lanes of less than 3.5 m are used, it may not be practical to achieve the goal of not changing lanes during the design storm when trucks and buses are considered. Where commercial vehicles comprise a significant proportion of the traffic, consider redistribution of lane widths to give a wider outer lane.
Auxiliary and turning lanes	<ul style="list-style-type: none"> Spread at the commencement of auxiliary/turning lane tapers should be limited to 1.5 m, except where cycle lanes or sealed shoulders are extended through the taper. In such cases up to 1 m of the cycle lane may be used for spread allowance for the 10% AEP storm.

²⁶ *Guidelines for stormwater runoff modelling in the Auckland region, 1999*

Situation	Requirement
Pedestrians	<ul style="list-style-type: none"> • Maximum spread from the kerb immediately upstream of pedestrian crossing points should be 0.5 m. • Maximum spread into the kerbside lane adjacent to bus stops (or other locations where pedestrians are expected in significant numbers) should be 0.75 m. • Design rainfall intensity to use for pedestrian facilities should be the 1.58 year ARI, ten-minute intensity, except in addition spread should be restricted to less than 1 m in the 10% AEP storm at pedestrian crossing points.
Cyclists	<ul style="list-style-type: none"> • Where a road contains separate bicycle lanes, the flow spread should be limited to 0.5 m. • For a shared bicycle and vehicle lane, the flow spread width should be limited to 1 m. • Design rainfall intensity to use for on-road cyclist facilities is the 20% AEP, ten-minute intensity.
On-street parking and car parks	<ul style="list-style-type: none"> • Flow width should be restricted to 2.0 m for the 50% AEP.
Cross carriageway flows	<ul style="list-style-type: none"> • Flows across the carriageway, such as those occurring at super elevation changes, median breaks, T-intersections of local streets and at the ends of traffic islands, must be less than 0.005 m³/s to reduce the risk of aquaplaning. The rainfall intensity to use for this situation should be 50 mm/h. (See Section 3.11.2: <i>Surface water management</i>)
Local road intersections	<ul style="list-style-type: none"> • Flows past terminating local roads must be limited to 0.030 m³/s for the 10% AEP storm.
Safety: Arterial roads	<ul style="list-style-type: none"> • Maximum flow depth x velocity $d_g \times V_{ave} = 0.3 \text{ m}^2/\text{s}$.
Safety: Kerbside	<ul style="list-style-type: none"> • For pedestrian safety, the maximum depth at the kerbside should be no greater than the top of kerb, and the product of gutter flow depth by average velocity $d_g \times V_{ave}$ should not exceed 0.4 m²/s.
Safety: Braking areas	<ul style="list-style-type: none"> • Water depth and width should be restricted at the approaches to traffic signals, highway ramp gores and in other areas where braking would be expected.

Source: Based on Alderson (2006)

Major event management design

Major event management design typically caters for storms up to the 1% AEP.

Major event flow should meet criteria in Table 43. Design should follow methodologies set out in Austroads *Guide to Road Design Part 5A*. Rainfall and run-off should be calculated according to Auckland Council's Stormwater Code of Practice (including specified allowance for climate change).

Where shoulders have been constructed, the actual flow width is in addition to the shoulder width.

Where the kerbside traffic lane is greater than 3.5 m, additional width (i.e. actual width of kerbside lane minus 3.5 m) may be added to the allowable spreads shown above.

Where the kerbside traffic lane is less than 3.5 m, deficit width (i.e. 3.5 m minus actual width of kerbside lane) must be deducted from the allowable spreads shown above.

Where a combined purpose lane is being utilised, e.g. a bus lane and cycle lane at 4 m wide, the maximum allowable spread is 1 m, depth at the kerbside should be no greater than the top of kerb, and the product of gutter flow depth by average velocity ($d_g \times V_{ave}$) should not exceed 0.4 m²/s.

Table 47: Major event – roadway flow limitations

Situation	Requirement
Where floor levels of adjacent buildings are above road level	<ul style="list-style-type: none"> Total flow contained within road reserve. Freeboard from peak flow level to habitable floors in accord with Building Code and unitary plan.
Where floor levels of adjacent buildings are less than 350 mm above the top of the kerb, and the fall on the footpath is towards the kerb	<ul style="list-style-type: none"> Greater than 100 mm: Water depth must be limited to 50 mm above top of kerb. Less than 100 mm: Water depth must be limited to top of kerb in conjunction with a footpath profile that prevents flow from the roadway entering on to the adjacent property. In these cases, compliance with Building Code and unitary plan may require separate approvals.
Where no kerb is provided	<ul style="list-style-type: none"> Above depths must be measured from the channel lip level plus 100 mm.
Pedestrian safety ¹	<ul style="list-style-type: none"> No obvious danger: $d_g \times V_{ave} \leq 0.6$ m²/s. Obvious danger: $d_g \times V_{ave} \leq 0.4$ m²/s.
Vehicle safety	<ul style="list-style-type: none"> Maximum height of energy line 300 mm above roadway surface for areas subject to transverse flow. The exception is specific floodway design and additional vehicle warning and protection, where $d_g \times V_{ave} \leq 0.3$ m²/s. On-street parking is not to be permitted where overland flow exceeds 0.3 m²/s.

¹ Obvious danger is interpreted as areas where pedestrians are directed to, or most likely to cross water paths, e.g. marked crossings and corners of intersections.

d_g = flow depth in the channel adjacent to the kerb, i.e. at the invert (m).

V_{ave} = average velocity of the flow (m/s).

Source: Adapted from DNRW (2007a)

3.11.1.4 Major/minor drainage

Minor system

The minor system, or primary drainage, caters for the first two design objectives above, i.e. environmental and serviceability.

The frequency of events for primary drainage design is generally defined by the unitary plan to be the 10% AEP design storm.

Major system

The major system, or secondary drainage, is designed for severe storm events, generally the 1% AEP design storm.

This storm run-off should generally be contained within the road reserve, with sufficient freeboard at the boundary to limit risk of discharge towards vulnerable property.

Flood flow should be directed to discharge from the road reserve at natural low points. Ensure that a weir discharge from the road to an overland flow path is specifically designed.

Where constraints to the road network result in surface flows exceeding safety criteria and no overland flow path discharge is available, high-capacity inlet systems may be used to reduce overland flow. Piped discharge from these devices should be kept separate from the primary piped network as far as possible, to reduce risk of blockage. The risk of debris blocking inlets should be considered.

3.11.2 Surface water management

Geometric design of roads must include consideration of surface drainage.

Road safety

The prime consideration for surface drainage is road safety. High-speed roads (operating speed > 50 km/h) must be designed with regard to the potential for aquaplaning. For all roads, the effects of spray must be minimised, especially at intersections.

Gradients

Longitudinal gradients of kerbed channels must be at least 0.5%. Any length of road with a gradient less than this must have provision to avoid ponding. This can be achieved with:

- A sag curve catchpit inlet, in which case the length of road channel less than 0.5% must be minimised
- Crossfall away from channel
- Sheet flow discharge over the road edge, or
- A grated drain channel or combined kerb and drain block.

Crossfall

Crossfall and longitudinal gradient must be considered together:

- Steep roads (>8%) should have maximum crossfall to shorten the drainage path to roadside collection
- Roads with a flat grade should have sufficient crossfall to clear surface water to the road edge
- Transitions from camber to superelevation should be developed at or away from sag and summit curves, to avoid flat areas.

Other guides

Road design for aquaplaning should follow the Austroads *Guide to road design, Part 5A Section 4*. Where concentrated flow crosses a carriageway, it must be less than the maximum flow in Table 42.

3.11.3 Stormwater treatment devices: Road drainage

Apart from the requirements for water sensitive design set out in Section 3.11.1.1 above, drainage design for roads should also meet the requirements below.

The water sensitive design context is provided by the Auckland Council Guideline document *Water sensitive design for stormwater*²⁷. Auckland Transport prefers a treatment train approach with the “right device in the right location”.

The preferred options for new developments and existing environments are shown in Section 3.11: *Road drainage*.

Construction

Devices constructed close to live load areas (roadways, paved areas, vehicle crossings) may require structural support which must be designed to carry appropriate horizontal or vertical loads. Precast or in-situ concrete walls or cells may be used where necessary.

Underdrains should generally be not less than 100 mm internal diameter.

Diameter rigid, smooth-bore pipes, perforated to inlet from coarse drainage material. Bends, junctions and inspection ports should be arranged to enable CCTV inspection, flushing and jetting. Flexible perforated pipe should only be used for underdrains to tree planting pits or as subsoil drains.

Geotextile cloth should only be used for mudstop at the perimeter of drainage devices constructed on clay or similar subgrade, not between elements of bio-retention devices. Filter socks should only be installed on perforated pipes used for subsoil drainage in inert materials.

Other uses of geotextiles in devices must be approved by Auckland Transport Chief Engineer.

²⁷ GD2015/004

Operation & maintenance manual

Design of treatment devices or a treatment suite must include a draft operation and maintenance manual. This should include a brief statement of the function of the device or suite in its local stormwater management context. The manual must include a schedule of inspections, cyclic and planned maintenance operations, which must be used to estimate operational costs. The completed O&M manual for all treatment devices must be provided to Auckland Transport for all assets to be vested.

3.11.3.1 Treatment Option Tool Box

Auckland Transport supports the treatment and management of stormwater runoff from the road area as part of an integrated stormwater approach for the area. This stormwater approach should be worked through with Auckland Transport early in the design process so that appropriate outcomes are achieved. While there are a number of treatment and management options available, not all designs are necessarily appropriate when located within the road. Designers must consider maintenance requirements when selecting treatment/management options.

Auckland Transport's acceptance of treatment and management options for existing and redeveloped road runoff or road runoff from new road surfaces have been grouped into three tiers:

- Tier 1 (T1): Auckland Transport will accept these devices/design options although most will have design constraints to ensure the right size and right place in the corridor
- Tier 2 (T2): Auckland Transport will accept these options on a case-by-case basis only. Written approval from Auckland Transport is required at design stage to confirm acceptance
- Tier 3 (T3): Auckland Transport will only accept these options by exception – departure from standard approval is required during design stage.

Table 48: Treatment and management options

Treatment /Management option	New roads	Existing roads
Pond	T3	T3
Wetland	T2	T2
Swale /Vegetated swale*	T1*	T1*
Site specific bioretention (lined/unlined)*	T1	T1
Soakage pits	T1	T1
Dry ponds	T2	T2
Proprietary devices#	T2#	T2#
GPTs/Catchpit filters/filter screens#	T2#	T2#

*This would be T2, if private lots are to discharge to swale.

* Bioretention devices in this table do not include pre-cast concrete box rain gardens, which are considered a proprietary device.

#All proprietary devices must have written approval from Auckland Transport prior to design acceptance. The use of pre-cast concrete boxes for rain gardens requires a Departure from Standard approval.

3.11.3.2 Bioretention: rain gardens and tree pits

Bio-retention devices can provide water quality treatment and retention (infiltration to ground). The use of proprietary rain gardens solely for detention is not acceptable in the road corridor.

Auckland Transport supports the use of rain gardens for water treatment and retention. Rain gardens should be designed to maximise the size of each device. Drainage design should be considered at a sub-catchment level and seek to reduce the number of smaller devices in favour of fewer, larger rain gardens.

The minimum surface area of a rain garden designed for the road corridor is 20 m². Devices smaller than this must seek Departure from Standard approval.

Auckland Transport will not accept multiple precast proprietary devices adjacent to each other in series. Where more than one precast unit is required, then a larger rain garden should be designed.

See also:

- Design of treatment devices should be in accordance with Auckland Transport's bioretention and swale design guides
- Vegetation plans must be in accordance with the Auckland Transport's *Bioretention planting guide*
- Where the design requires a drop-off from the roadway or footpath into a device, kerbing may be required as per Section 3.11.4: *Kerbs and channels*
- Bioretention devices will not be considered for slopes of >5% unless safety issues are addressed. See Auckland Transport's *Bioretention Design Guide* for more information.

3.11.3.3 Ponds and Wetlands

Constructed ponds and wetlands are generally placed in the lower areas of a catchment, as a final stage of the treatment suite. Where these devices are accepting runoff from areas in addition to the road corridor, they are typically vested to Auckland Council.

Wet pond

A pond that has a standing pool of water with a permanent water level.

Dry pond

A dry pond (also called a detention basin) temporarily stores stormwater runoff to control the peak rate of discharges without having a standing pool of water. Due to the fully emptying nature of a dry pond, they do not provide full water quality management and pre-treatment of runoff entering these areas is required.

Wetlands

Auckland Transport supports the use of wetlands for treatment and retention/detention. Designers considering wetlands for retention method should seek advice from Auckland Transport Chief Engineer early in the design process.

See information sources in Section 3.11: *Road drainage*, for design information.

3.11.3.4 Swales and vegetated swales

Auckland Transport supports the use of swales for conveyance and treatment (where designed) however, these devices require sufficient width and length to function well.

Check dams may be required to limit the gradient of the base of the swale to 5% or less. Swales will not normally be suitable where the road gradient exceeds 8%.

They should not be used in residential local roads with multiple vehicles crossings, or other roads where berm parking is likely to occur. Swales with approved vegetation other than grass may be acceptable in such roads.

Where services are to be laid under swales, the service excavation trench including tool working clearance must not affect any subsoil collector drain, and access pits and covers must not obstruct the designed waterway.

Swale design must comply with:

- Auckland Transport's *Swale design guide* and *Biorientation planting guide*
- Section 3.11.8: *Subsoil drains*.

3.11.3.5 Soakage Pits

Soakage pit systems have performance specifications that are limited to only a few areas within the Auckland region. Design standards are available in *Stormwater disposal via soakage in the Auckland region*²⁸, referenced in Section 3.11: *Road drainage*.

3.11.3.6 Proprietary devices

Proprietary devices will be considered by Auckland Transport on a case-by-case basis for use within an existing drainage network. Such devices typically require specialised maintenance and must be specifically approved in writing by Auckland Transport before being used within road designs. Such devices may include:

- Gross pollutant traps and catchpit filters/screens
- Pre-cast concrete boxes/rain gardens
- Manhole or vault-based filter systems
- Other manufactured products.

Note: Letters issued by Auckland Council approving the use of proprietary devices does NOT apply to their use in the road corridor.

²⁸ TR2013/040, Auckland Council

3.11.3.7 Devices not accepted

Auckland Transport does not support the use of these devices within the public road corridor due to the maintenance requirements:

- Pervious paving
- Sand filters
- Gravel trenches
- Tanks (retention and detention).

3.11.4 Kerbs and channels

Kerbing may be required for surface water control:

- On all roads where the channel gradient exceeds 8%
- On all roads where the channel gradient exceeds 5%, unless a side drain system is provided that collects surface water effectively along its length
- Roads with side drains/water tables where the road passes through a cutting and the side drain is interrupted.

Plans

The surface water kerb and channel profile should be selected from one of the details in Auckland Transport TDM SED KC0001 – KC0030 and meet the criteria in Section 3.11.1.3 for major event drainage.

Kerb types

For drainage systems using catchpits as in Section 3.11.5: *Kerb types*, 1 or 3 will normally be suitable. Other kerb types may require transition over at least 600 mm between the kerb and a catchpit lintel.

Interruptions

For vehicle kerbing, interruptions must normally not exceed 300 mm in length and be at least 600 mm apart, with inlet capacity designed as a weir. The operating speed environment should be 60 km/h or less.

Protection for drop-off from footpath

For footpaths, protection must be provided where there is a drop-off or steep batter adjacent to the footpath edge. An upstand kerb must not be less than 75 mm, with short interruptions for inlet. Where edge rails are used, the bottom rail must have a gap of 75 mm or less below the rail. Alternatively, drop-off can be limited to no more than 25 mm to a paved margin 500 mm wide, or a side slope not exceeding 1:3 within a rain garden. The safety of road users/pedestrians must be considered if rain gardens are to be located in the berm.

Paved areas without kerb

Where an upstand kerb is not provided in paved areas, a concrete drainage channel must be provided. The standard concrete V-channel profile should be used.

Run-off from adjoining land

Where adjoining land falls towards a road, and the road surface falls away from the road edge (superelevation or single crossfall), a channel profile is required to intercept:

- Significant sheet flow from a wide paved area or
- Prolonged surface flow from a pervious landscaped area.

In this case, the length of channel flow to a catchpit must be limited by the capacity of the channel profile. It may be sufficient to design channel flow capacity for 50% AEP, where prolonged surface flow is the problem.

Other guides

Provision of kerbs and selection of kerb profile for traffic purposes should be as described in Auckland Transport's Engineering Design Code, *Urban and rural roadway design*.

3.11.5 Catchpits and continuous inlets

Catchpits are provided to drain the carriageway and to retain sediment or silt. Continuous inlets include combined kerb and drain blocks and grated channel drains.

Combined kerb and drain blocks

Combined kerb and drain block systems may be appropriate for flat or steep road edges. They can drain intersection areas where conventional kerb and channel would require catchpits that would be difficult to maintain safely. They can be used to drain areas that would pond due to vertical traffic calming features, with discharge either returned to road channel downstream of the feature or to a catchpit sump for connection to an outlet. Proprietary systems may be used subject to approval by Auckland Transport Chief Engineer.

Grated channel drains

Grated channel drains or slot drains may be appropriate to drain some areas, especially flat areas with wide sheet flow, or to intercept surface flow to protect vulnerable property below the paved area. Channel or slot drains may only be used where areas cannot be laid to fall to surface channels or to spread-entry treatment devices. (This could be due to trip hazards, excessive gradients, or excessive surface water in areas of heavy pedestrian activity.) Every channel or slot drain must discharge to a catchpit designed to suit that channel system.

Technical requirements

Catchpits used in all public roads must comply with this manual, including:

- All catchpits draining to combined networks must have a water-trap discharge to prevent odours from the combined sewer system escaping from the catchpit. This should generally be in the form of a half-siphon as shown in Auckland Transport's Engineering Design Standards
- All catchpits must include a silt trap sump of at least 450 mm deep
- Catchpits in town centres, or discharging directly to streams, public beaches or amenity water, including ponds and wetlands, must be fitted with approved gross pollutant traps

- Catchpits discharging to soakage should include inserts to trap gross pollutants.

3.11.5.1 Catchpit location

Catchpits should generally be located:

- At spacing determined by road surface drainage calculations, particularly for very flat or very steep gradients
- In channels draining one lane, so that the water run in any channel is no longer than 90 m, unless specific calculation is done
- In channels draining two lanes, so that the water run in any channel is no longer than 60 m, unless specific calculation is done
- At sag points in road channel
- Upstream of pedestrian and cycle crossings, at least 10 m from the approach side of the crossing
- At raised tables
- At least 10 m from the kerb line tangent points, if the road falls to an intersection
- At changes of gradient or direction in the channel, where there may be a tendency for water to leave the channel or to pond
- At changes of crossfall, where significant flow will leave the channel and cross the roadway
- Avoiding locations likely to conflict with future vehicle crossings.

For all above cases, the location should allow for safe operation when cleaning pits and minimize traffic management requirements.

3.11.5.2 Catchpit design

Catchpit openings must not pass an object greater than 100 mm in its smallest dimension.

Catchpits located on gradients must be designed for their inlet capture capacity, and any bypass flow must be added to the flow in the next sub-catchment.

Low points in road

A catchpit located at the lowest point in a sag vertical curve, or at the end of a cul-de-sac where water falls to the end, must be designed for a sump condition inlet with sufficient capacity to handle bypass flow that concentrates to that point and must allow for blockage.

They must be either:

- Double standard catchpits
- Splay catchpits
- Street catchpits of 500 x 800 mm
- Mega pit or
- Another pit type with sump inlet capacity that allows for sufficient flow, even with blockage.

Inlet capacity

Inlet capacity should be taken from manufacturers or suppliers' data for approved types, or from verified testing of data for new types, or from approved design charts.

- Standard catchpit 670 x 450 mm should be taken to have nominal inlet capacity of 28 l/s installed on a gradient
- Corrections must be made for crossfall less than 3%.

Calculated catchpit inlet capacity must be reduced to allow for partial blockage of the inlet as follows:

Table 49: Allowance for inlet blockage

Location	Inlet type	Proportion of nominal capacity
Sag point	Kerb inlet	80%
	Grate	50%
	Combined	100% of kerb inlet only
	Continuous	100%
On-grade	Kerb inlet	80%
	Grate	50%
	Combined	90%
	Continuous	100%

Notes:

Combined means a grate with kerb inlet or back entry.

Continuous means a grated or slot channel or combined kerb drainage blocks with close-spaced inlets.

Inlet capacity may be limited by capacity of the downstream network. Where such limitations apply, design must show how serviceability standard can be met both short-term and with future capacity upgrade.

3.11.5.3 Catchpit approved types

Public catchpits for all new development must be selected from the approved catchpit designs in Table 50: Typical use of catchpit types.

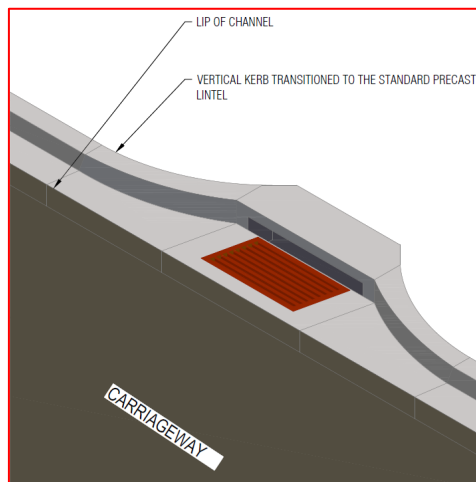

Figure 90: Semi-recessed catchpit

Table 50: Typical use of catchpit types

Type	Use
Semi-recessed	<ul style="list-style-type: none"> All catchpits with grates should be semi-recessed to ensure the channel lip line continues straight at apron, unless a recessed kerb line would create a hazard for footpath users.
Standard catchpit	<ul style="list-style-type: none"> Local streets and other locations where spacing is determined by factors that limit catchment to less than 28 l/s. Where kerbside bus or cycle use is likely, cycle-friendly grates and aprons must be used, which will reduce inlet capacity.
Street catchpit 500 x 800 mm	<ul style="list-style-type: none"> Any street where channel flow can exceed inlet capacity of standard catchpit.
Grate only	<ul style="list-style-type: none"> Locations where a back entry cannot be provided, such as V-channel or Kassel kerb. Care is needed to provide for by-pass flow due to risk of blockage. Use should be avoided by locating catchpits where upstand kerb can be installed.
Splay pits and similar	<ul style="list-style-type: none"> Pits without grates may be used where semi-recessed pits would be hazardous to footpath users. These types of higher-capacity inlet can also be used with catchpit manholes, sized to suit the pipeline running from them. This can reduce the number of chambers and leads required in a drainage system.
Mega pit or similar	<ul style="list-style-type: none"> High inlet capacity used where flood flows must be captured fully or partially to piped drain, to ensure overland flow does not exceed acceptable criteria.
Field catchpit	<ul style="list-style-type: none"> For use away from roadway, adjacent to footpaths or landscaped areas that cannot be drained otherwise.
Other types	<ul style="list-style-type: none"> Innovative designs should be discussed with Auckland Transport before being proposed.

3.11.5.4 Catchpit inlet selection

Inlet weirs and grates should be selected from the types shown in Auckland Transport TDM SED RD0000 series or the list of approved types kept by Auckland Transport.

Catchpit grates

New and replacement grates and frames must meet Auckland Council and Auckland Transport safety requirements. Grates should be:

- Spring-latched
- Captive hinged
- Flat topped
- Frame support allowing closure without clogging by debris.

Catchpit lintels

The standard concrete lintel for 675 x 450 mm catchpit has a limited capacity. If the inlet capacity required exceeds this, especially for an existing catchpit, the capacity can be increased by installing an extended concrete lintel, which may be effective on steep gradients, or a galvanised steel lintel.

Cycles and buses

Any catchpits on a road used by cyclists or buses close to the drainage channel line must be provided with cycle-friendly inlets.

Pedestrians

Any catchpits in locations with foot traffic must be provided with pedestrian friendly inlets.

3.11.5.5 Catchpit leads

Minimum diameter

All leads must be at least 225 mm diameter, except as indicated below. Where catchpits are located at sag points in the road, leads must be at least 300 mm diameter.

Leads from certain devices specify minimum sizes larger than 225 mm. This specified size will determine the minimum size of pipes downstream from that lead. Any proposed connection to a pipeline of smaller diameter requires approval from the Auckland Council Stormwater Unit.

Maximum length

Catchpit leads should not exceed 30 m in length.

Connection

A catchpit lead should not normally connect to another catchpit. However, where pipe maintenance access for jetting is available from the inlet and subject to pipe capacity, it may connect to another catchpit lead, using a fabricated 90° or 135° junction.

Catchpit leads connecting to a piped stormwater network should normally be connected at a manhole. Where connection to a manhole:

- Would require an excessively long lead
- The gradient is insufficient, or
- The connection is difficult because of manhole integrity or obstruction of the direct line, a saddle or branch connection to the pipeline may be considered, subject to Auckland Council's *Stormwater Code of Practice* requirements. Material for the pipe may be governed by the material required for a fabricated connection.

Connections between concrete pipes or chambers and pipes of other materials must be designed and constructed to be watertight, allowing for deformation. For example, a concrete stub pipe may be used from a concrete catchpit chamber to allow a flexible lead to be used, with a proprietary connector. All connections should be finished or inspected from inside and outside of the pipe.

Bends

If a catchpit lead cannot be laid straight due to obstructions, its length should not exceed 15 m and large-radius bends should be used to allow maintenance.

Outlet

Catchpit leads discharging to land, to a watercourse or to an open channel drain must be provided with a suitable outlet structure complying with Stormwater Code of Practice²⁹ requirements.

3.11.6 Manholes

The design of manholes should be in accordance with the Stormwater Code of Practice with the following additions:

- Manholes must be located in the berm or footpath. Where this is unavoidable, manholes in the roadway should be located within parking lanes, or between wheel tracks in traffic lanes
- Manholes at intersections must be located in a position where there is safe access using economical traffic management
- Hinged lids must be installed to close in the direction of traffic movement. Avoid placing hinged lids in a traffic lane in the opposite direction to an overland flow path with significant depth and velocity
- Manholes within the roadway require specific pavement design of backfill to avoid differential settlement and load transfer from rigid to flexible pavement foundation.

3.11.7 Rural road drainage

Rural roads must be designed with regard to topography and existing land drainage.

²⁹ Auckland Council Code of practice for land development and subdivision, Chapter 4: Stormwater

The shape and location of the roadside drain must consider road safety. Preferred side slopes should be 1:6, with a 1.2 m wide level base. Where this cannot be achieved, design must be as per Austroads *Guide to road design* Part 6³⁰. Steep-sided ditches, or deep channels will not be accepted within the clear zone of the road, unless a safety barrier is provided.

Capacity

Adequate drainage channels must be formed, so that the design water level is below subgrade level. The capacity must meet requirements for serviceability design for the road.

Cut-off

Adequate cut-off must be provided, so that the maximum length of the flow path in the road drainage channel does not exceed 200 m. Table drain blocks within the channel downstream from a cut-off drain should be provided to ensure the flow is captured by the cut-off drain.

The cut-off must discharge to a natural watercourse, by way of an open drain along a lot boundary. Open drains through the body of the lot will generally not be acceptable. All such cut-off drains through private property must be protected by way of a drainage easement registered on the title of the property or properties affected. Where the easement is a specific one, i.e. not an easement in gross, it must be a minimum width of 3 m to allow for easy maintenance access. Where discharge is through a residential lot, all or part of its length may need to be piped. Access for outlet inspection and maintenance must be demonstrated.

Grades

The minimum longitudinal grades of water tables must be 1:100 (1%).

Erosion

Where the gradient of a roadside drain channel exceeds 5%, provision should be made for velocity control and erosion protection.

Auckland Transport may require drainage channels along the top of fill batters to control erosion. The road drainage channel must be designed to consider the whole of the contributory catchment.

3.11.8 Subsoil drains

Piped subsoil drains must be provided at all locations where water may pond, or where groundwater may rise to the subgrade, e.g. natural springs or concentrated flow under steep roads. This can also happen near under-verticals or other areas where the footpath will otherwise be exposed to wet sheet flow from groundwater in the berm. The road pavement design may require subsoil drains.

Where subsoil drains pass within the planned root growth zone of trees, unperforated pipes with sealed joints must be used for the length of the zone, unless otherwise protected by their design.

³⁰ *Drainage – Open channels, culverts and floodways*

The principles of subsoil drainage design are detailed in Austroads *Guide to road design* Part 5³¹.

- Subsoil drains should be as shown in Auckland Transport TDM SED RD0010
- Design for subsoil drains must be as per NZ Transport Agency specification F2:2013 (Specification and Notes).

3.11.9 Minor culverts

Minor culverts are those conveying storm water under roads, with a cross sectional area less than 3.4 m². (Refer Auckland Council *Code of practice for land development and subdivision*, Chapter 4: Stormwater Section 4.3.9.8 for more details.)

Refer to the above Stormwater Code of Practice and NZTA Bridge Design Manual for major culverts.

Culverts must comply with requirements for energy and environmental effects including fish passage as described in Auckland Council TR 2013/018, *Hydraulic energy management: inlet and outlet design for treatment devices*

Inlets and outlets

Inlets and outlets must be provided as per Auckland Council *Code of practice for land development and subdivision*, chapter 4: stormwater.

The safety of all road users should be considered in designing inlets and outlets. Fencing around inlet/outlet structures is required unless it can be demonstrated that human access to the inlet/outlet structure is unlikely and/or the height of the structure is less than 1.0 m.

Inlet or outlet structures must be provided with vehicle restraint protection as described in the *Urban and rural roadway design* document of the Engineering Design Code.

If they are within the clear zone, inlet or outlet structures for pipes that cross roads should be sloped to match the drain or embankment slope.

Pipes under side road intersections or driveways should have traversable ends if they are within the clear zone.

Cut-off drains

Culverts conveying run-off from roadside drains under the roadway or away from the roadway to discharge points as minor drainage, must be designed to provide capacity for at least 10% AEP flow. Inlets must be designed to capture this design flow without significant bypass.

Culverts designed as part of the major drainage system, must have capacity for 1% AEP flow.

³¹ *Drainage – General and hydrology considerations*

Vehicle crossing culverts

Where a vehicle crossing is to be constructed or redeveloped to cross a roadside drain or swale, and there is less than 200 m of roadside drain upstream from the crossing without a cut-off drain, a culvert must be installed. Vehicle crossings paved to the profile of the swale is permitted where subsoil drainage prevents prolonged seepage flow across the crossing and is required for swale capacity for 10% and 1% AEP run-off.

The minimum internal diameter of a vehicle crossing culvert is 300 mm.

Where the vehicle crossing crosses a stream or other natural water course then the minimum internal diameter for the culvert shall be as per the Auckland Council *Code of practice for land development and subdivision*, Chapter 4: Stormwater. Culverts for vehicle crossings must also comply with requirements for fish passage as described in Auckland Council TR 2013/018 and NPS-FM 2020.

For any other roadside drain or watercourse, a crossing culvert pipe should be designed with a capacity of 20% AEP flow without exceeding the capacity of the upstream drain, and so that 10% AEP flow does not exceed the allowable channel flow width, or spill from the road boundary. Culvert capacity is to be determined for run-off from the Maximum Probable Development of land upstream.

3.11.10 Special areas

Waiheke Island and other Hauraki Gulf Islands, together with the Waitakere Ranges have special requirements associated with stormwater drainage.

Designers must contact the Chief Engineers and Asset Management Group for advice on designing/implementing appropriate stormwater drainage in these areas.

Refer to Waitakere Ranges Heritage Area Act (2008) and the Auckland Transport *Waitakere Ranges Design Guide*.

3.12 Street lighting

This section provides a guide to everyone involved in the management and design of public lighting installations.

Where clauses in this chapter differ from the standards referred to, this document takes precedence.

Appendices referred to in this section are published in Auckland Transport Design Manual supporting Appendix documents.

3.12.1 Applicable standards

Street lighting must be designed and installed in accordance with all applicable standards with all current amendments, including;

- AS/NZS 1158 Lighting for Roads and Public Spaces
- AS/NZS 3000 Australia/New Zealand Wiring Rules
- AS/NZS 7000 Overhead Line Design
- Auckland Transport Design Manual
- AT ECS Electrical Cable Specification
- AT PS ECS Private Subdivision Electrical Cable Specification
- ESE 406 Overhead Standard Structures with street lights.

All new lighting designs must use LED luminaires.

Legal frameworks & regulatory

All works must be carried out in accordance with all relevant statutes, bylaws and regulations, with all current amendments, including:

Electrical Codes of Practice (ECP) and standards referenced therein.

- New Zealand Radio Interference Notices 1958 and 1985 and Radio (Television) Interference Notice, 1961
- Electricity Act, 1992
- Electrical (Safety) Regulations, 2010
- Health and Safety at Work Act, 2015
- Relevant Statutory Acts, Regulations and Bylaws.

The requirements of Network Supplier's Health and Safety Standards (NHSS).

3.12.2 Lighting design

All new or replacement luminaires must be LED luminaires.

3.12.2.1 Road classification

The AS/NZS 1158.1.1³² and AS/NZS 1158.3.1³³ standards should be used to determine the appropriate lighting classification and sub-category. To assist this process, there are V and P Category Calculator Tools available in Appendix J.

Auckland Transport has elected to adopt higher design categories. Hence, category P3 designs must satisfy P3 (i.e. not P3(NZ) or P3R). Similarly, P4 designs must satisfy P4 (i.e. not P4R).

Accessways

Access ways must be lit to the appropriate P category as set out in the current version AS/NZS 1158 3.1. Table 2.2 of that document defines the criteria for determining the lighting subcategory. Then use the Auckland Transport P Category Calculator Tool Appendix J2) to assist with the classification.

Consider the use of 4 m high lighting columns to limit spill light.

Other spaces

Other spaces (e.g. public precincts, transport terminals) will be classified as per AS/NZS 1158.3.1.

The lighting design must comply with requirements set out in the TDM and including, but not limited to, the current version of:

- AS/NZS 1158 and all current parts
- ECP 34 Electrical Code of Practice.

³² Part 1.1 Vehicular traffic (Category V) lighting, 2005

³³ Part 3.1 Pedestrian area (Category P) lighting, 2020

Checklist

The checklist below must be completed when submitting a proposed lighting design for approval.

Table 51: Lighting design submission checklist

1	Initial considerations	<ul style="list-style-type: none"> a. A holistic approach to the lighting design has been considered. b. A night site visit (where applicable) has been completed, identifying features such as CCTV cameras, trees and neighbouring properties. 	<input type="checkbox"/>
2	Area classification	<ul style="list-style-type: none"> An appropriate lighting sub-category classification has been agreed with Auckland Transport for all roads with the design scheme. The lighting classification/sub-category for each road is: [List each here] 	<input type="checkbox"/>
3	Light source	<ul style="list-style-type: none"> Only LED luminaires are proposed. 	<input type="checkbox"/>
4	Luminaire selection	<ul style="list-style-type: none"> Only luminaires included on the Auckland Transport LED (Appendix F) road lighting specification approved list are being used in the design scheme. Alternative luminaires may be submitted for approval on a specific project; however these will have to be assessed against the standards in Appendix B and must be approved by Auckland Transport before design begins. 	<input type="checkbox"/>
5	Lighting column	<ul style="list-style-type: none"> Only Lighting Columns on the Auckland Transport Lighting Column (Appendix H) Specification Approved List were used in the design. Alternative lighting columns may be submitted for approval on a specific project However these will have to be assessed against the respective standards in Appendix D and must be approved by Auckland Transport before design begins 	<input type="checkbox"/>
6	Electrical considerations	<ul style="list-style-type: none"> Electrical reticulation has been specified (where applicable). 	
Checked by:		Date:	

3.12.2.2 Design criteria

The straight road theoretical power density for the road reserve (P category) or carriageway (V category), with the proposed luminaire at the proposed mounting height, tilt and location, shall not exceed the following Power Density (PD) limits.

Category	P4	P3	V4	V3	V2	V1
Power density limit (w/m ²)	0.042	0.058	0.26	0.29	0.38	0.60

Power density shall be determined using the maximum theoretical spacing in metres (S) [calculated using SAA STAN software such as Perfectlite™], the total input power in watts for the luminaire (P) and the road width in metres (W) [Reserve width for P Cat, Carriageway width for V Cat]. Note: This requirement applies to the maximum theoretical spacing only. The power density for the actual design will generally be higher due to placement constraints.

The power density formula is as follows:

$$PD = P/(S*W)$$

Light spill

- AS/NZS 1158 *Lighting for Roads and Public Spaces* gives requirements on the obtrusive effects of public lighting. Further guidance is provided in AS/NZS 4282: *Control of the Obtrusive Effects of Lighting*.
- In addition:
 - The maximum tilt for a luminaire must be zero degrees for P Category and 55° for V Category (zero preferred) from the horizontal unless otherwise approved by Auckland Transport
 - External screens must not be used.

Luminous intensity (glare)

- P category roads: For new designs, Auckland Transport requires the luminous intensity at Gamma 80 to be limited to 400 cd and the peak intensity between 60° & 80° vertical at any horizontal angle to 1,800 cd.

Threshold increment

- V category roads – The Threshold Increment (TI) along the road must be no greater than 12%, with the pedestrian traffic lights as well as the adjacent street lights included in the calculation.

3.12.2.3 Trees and road lighting columns/ luminaires

Existing trees

- For mature tree lined roads with trees on one side, columns should be on the opposite side. If there are trees on both sides, lighting columns on each side may be required, located midway between trees, with long outreach arms to reach out under the canopy.
- Lighting columns should be located outside the dripline.

New trees

- Where new trees are proposed, lighting columns must be located first to provide the correct lighting levels in accordance with AS/NZS 1158 and this manual. Only then should trees be located to create the daytime aesthetics.
- Provide a minimum clearance of 2 m from the dripline. Also consider the use of 6 m columns in treed subdivisions.

3.12.2.4 Overhead reticulation

Brackets on distribution company poles must comply with the ESE 406 joint Vector and Auckland Transport standard.

3.12.2.5 Underground services

The Design Engineer shall obtain existing services plans from B4 U DIG and ensure that all necessary clearances required by the utilities are maintained.

High pressure gas requires significant clearances.

3.12.2.6 Maintenance factor

The Design Engineer shall use the method set out in the LED Road Lighting Luminaire Assessment Checklist in Appendix B to calculate Lumen Depreciation and to calculate the design Maintenance Factor (MF).

The designer shall also obtain the lighting manufacturer's lumen maintenance calculation, based upon their proprietary method of determining lumen depreciation over 85,000 hours (energised time), 25C ambient and LMF of 0.92 for a luminaire with a visor or 0.78 for a luminaire with exposed optics (unless a more stringent factor is applicable), allowing for all electronic and optical degradation factors. The LMF factors provided in BS5489 may be used in lieu of those recommended in AS/NZS 1158.

The designer shall use the most conservative of the two maintenance factors for the design.

3.12.3 Lighting columns

All street light columns must comply with the Street Lighting Column Specification and Assessment Methodology in Appendix D. All columns used in design must be on the approved list Appendix H.

3.12.3.1 Lighting column location within the road reserve

Minimum setback

Consider the standard proposed street cross sections shown in the Street Furniture (Section 3.4.4). The preferred location for columns is in the front grass berm. Where this does not exist, locate the column immediately behind the nominal 1.8 m wide concrete footpath.

Unless otherwise agreed with Auckland Transport, the minimum column set back must be in accordance with AS/NZS 1158, clarified as follows. This shall apply equally to both V and P category roads unless stated otherwise.

1) General (from kerb face to the face of the column):

- 1 m unless otherwise noted
- On V category roads – 1 m where outside conflict areas (refer to AS/NZS1158.1.2 clause 8.6.1), or 3 m otherwise.

2) Frangible Columns (energy absorbing or shear base):

- If kerb present – as above
- If no kerb present – distance from road edge (painted line or edge of tar seal otherwise);
 - 1 m minimum behind a rigid barrier (e. concrete)
 - Beyond the deflection zone of a non-rigid barrier (e.g. guard rail or wire rope)
 - 3 m minimum where there is no barrier.

3) Rigid columns:

- Posted speed limit 70 kph or less as for sections 1) & 2) above
- Posted speed limit greater than 70 kph
 - Rigid columns are not to be used within 6 m from the road edge if there is no kerb and no barrier
 - As for sections 1) & 2) otherwise.

4) Joint use (traffic signal lighting) columns:

- In accordance with traffic signal column requirement.

New subdivisions

In new subdivisions, lighting columns must be located:

- At the common boundary between adjacent property lots, or
- On the build line, i.e. the corner of a building within the property lot (this is particularly relevant in regards to point c below), or
- Within 15 m of the corner if it is the first lighting column in a side street. Measure from the property boundary facing the street that vehicle has turned from. The column should be on the driver's left side.

Footpaths

Street lighting columns should be clear of footpaths. Where this is not possible, place them towards the back edge of the footpath. Maintain a clear 1.5 m minimum footpath space.

Bus stops

A lighting column shall be located within 10 m on the approach side of the bus stop.

Under overhead power lines

Where it is required to locate a lighting column under an overhead low voltage (LV [400/230V]) power line there must be a minimum of 1 m clearance between the overhead conductor and the top of the lighting column at all times.

Lighting columns must not exceed a height of 4 m. The luminaire must not protrude beyond the front face of the kerb.

The maximum upward tilt must not exceed 5°. For voltages greater than LV, ECP34 shall apply.

3.12.4 Luminaires

Standards

Luminaires must be manufactured and tested in accordance with SA/SNZ TS 1158 6: *Lighting for roads and public spaces*; AS/NZS 60598 2 3 (general requirements for luminaires) and NZ Transport Agency specification M 30: *Specification and guidelines for road lighting design*.

Approved luminaires

All roadway luminaires must comply with Auckland Transport *LED Road Lighting Specification* Appendix B and be included on the approved list Appendix F.

Auckland Transport requires all new luminaires to be LED type.

The approval process for roadway LED luminaires is set out in Appendix B.

Approved list

All new lighting designs must use luminaires from the appropriate approved list.

Appendices F & G

The current approved lists are shown in:

- Appendix F, Road Lighting LED Approved Luminaire List (AT LALL)
- Appendix G, Amenity Lighting LED Approved Luminaire List (AT ALAL).

NEMA receptacle

Roadway luminaires must be fitted with either a 5 or 7 contact NEMA receptacle, compliant with ANSI C 136 41 2013³⁴.

LED Driver

The driver shall be DALI dimmable constant current driver.

³⁴ *Roadway and area lighting area equipment dimming control, 2013*

In-ground up-lights

In-ground up lights must not present a tripping or slip hazard.

Internal anti-glare attachments must be positioned to limit the upward light. In addition, these lights must:

- Meet AS/NZS 60598.1³⁵
- Have impact resistance of IK10
- Have ingress protection of IP67 or IP68 (preferred).

Bollard luminaires

The use of bollard luminaires must be pre-approved by Auckland Transport. The construction and finishes of bollard luminaires must be consistent with the requirements for columns and luminaires. The maximum luminous intensity in any normal viewing direction must not exceed 500cd/m²

In-fill luminaires

Infill luminaires must be LED type unless specifically agreed otherwise with Auckland Transport.

Labelling

Labelling must be in accordance with the current version of SA/SNZ TS 1158.6³⁶.

3.12.4.1 Light source

LED Road lighting

Only LED luminaires meeting the LED Road Lighting Luminaire Specification Appendix B and included on the Auckland Transport approved list Appendix F, or the NZ Transport Agency M30³⁷ approved list may be used for Category V and Category P lighting designs. All new or replacement luminaires must be LED luminaires.

Lamp replacements

HID lamp replacements must utilise the minimum rated lumens defined in Appendix A , HID Road Lighting Specification.

³⁵ *Luminaires – Part 1: General requirements and tests, 2017*

³⁶ *Lighting for roads and public spaces – Part 6: Luminaires – Performance, 2015*

³⁷ *Specification and guidelines for road lighting design, 2014*

3.12.5 Road lighting in specific areas

3.12.5.1 Rural road lighting

Road lighting in rural areas is addressed in AS/NZS 1158.1.1³² Clause 3.5.

3.12.5.2 Pedestrian crossing lighting

Standards

Pedestrian crossings must be lit in accordance with the current version of AS/NZS 1158.4³⁸. Luminaires shall have a photometric distribution specifically designed to suit pedestrian crossings. Use LED luminaires.

Unsignalised

The design criteria in AS/NZS 1158.4 shall apply at un-signalised crossings.

At an un-signalised pedestrian crossing, AS/NZS 1158.4 allows the use of a Belisha disc or a flashing Belisha beacon. Auckland Transport will specify which is appropriate for the specific crossing.

Signalised

No specific requirements.

3.12.5.3 Traffic calming devices

Category P lit roads

At local area traffic management devices, including roundabouts, speed tables, speed humps, pedestrian refuges etc intended to:

- Slow traffic on category P roads: Achieve 3.5 lux horizontal point illuminance in accordance with AS/NZS 1158.3.1³⁹ on the approach faces of the device. This is not additional to road lighting
- Deter traffic on category P roads: Install reflective devices as per the Manual of Traffic Signs and Markings (MOTSAM).

Category V lit roads

Refer to AS/NZS 1158.1.1³² for lighting of traffic management devices on V category roads.

³⁸ Road lighting – Lighting of pedestrian crossings, 2009

³⁹ Lighting for roads and public spaces – Part 3.1: Pedestrian area (Category P) lighting 2020

Appendices

Appendix A: Swept path graphs for design vehicles

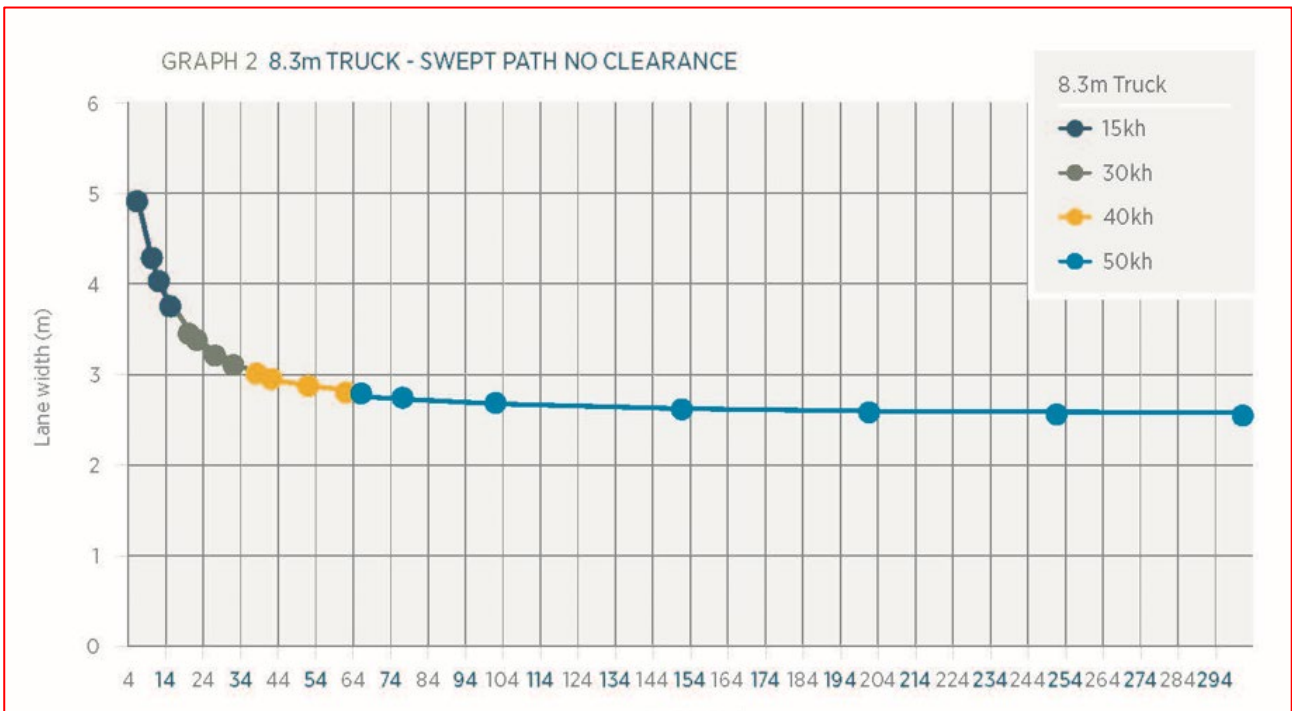
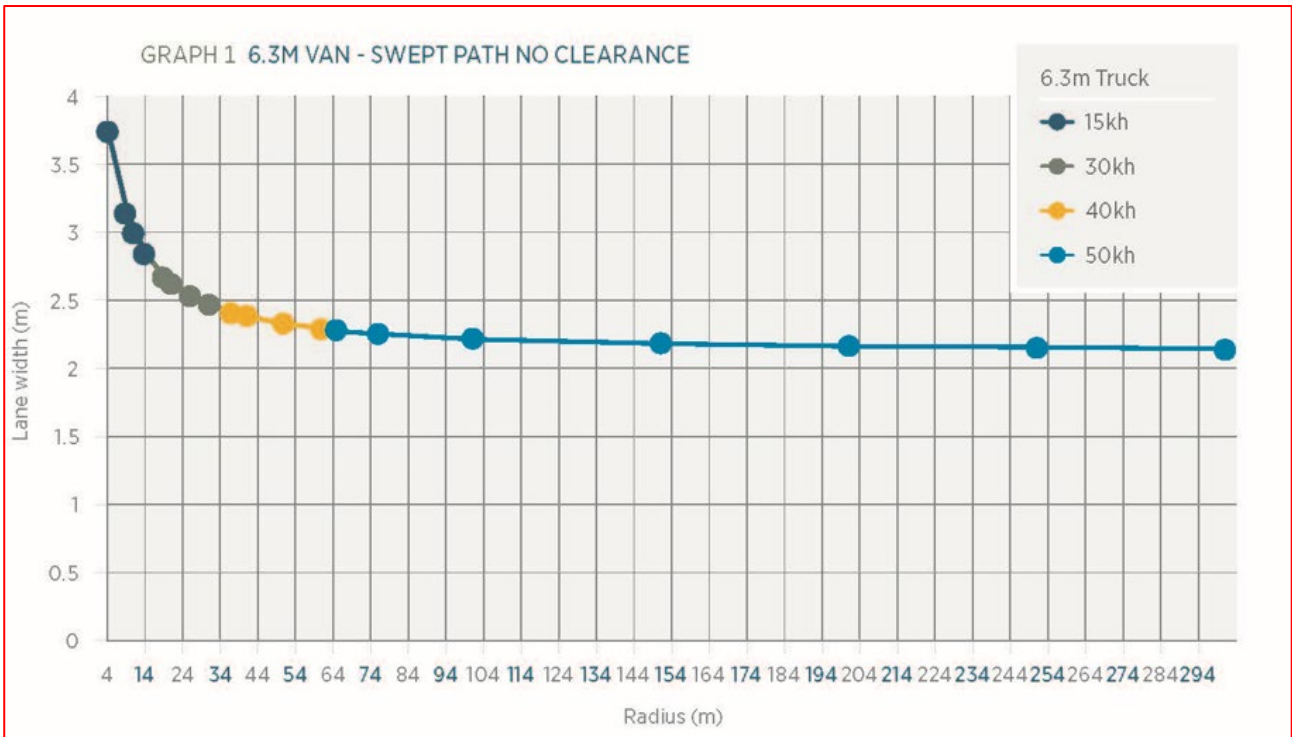

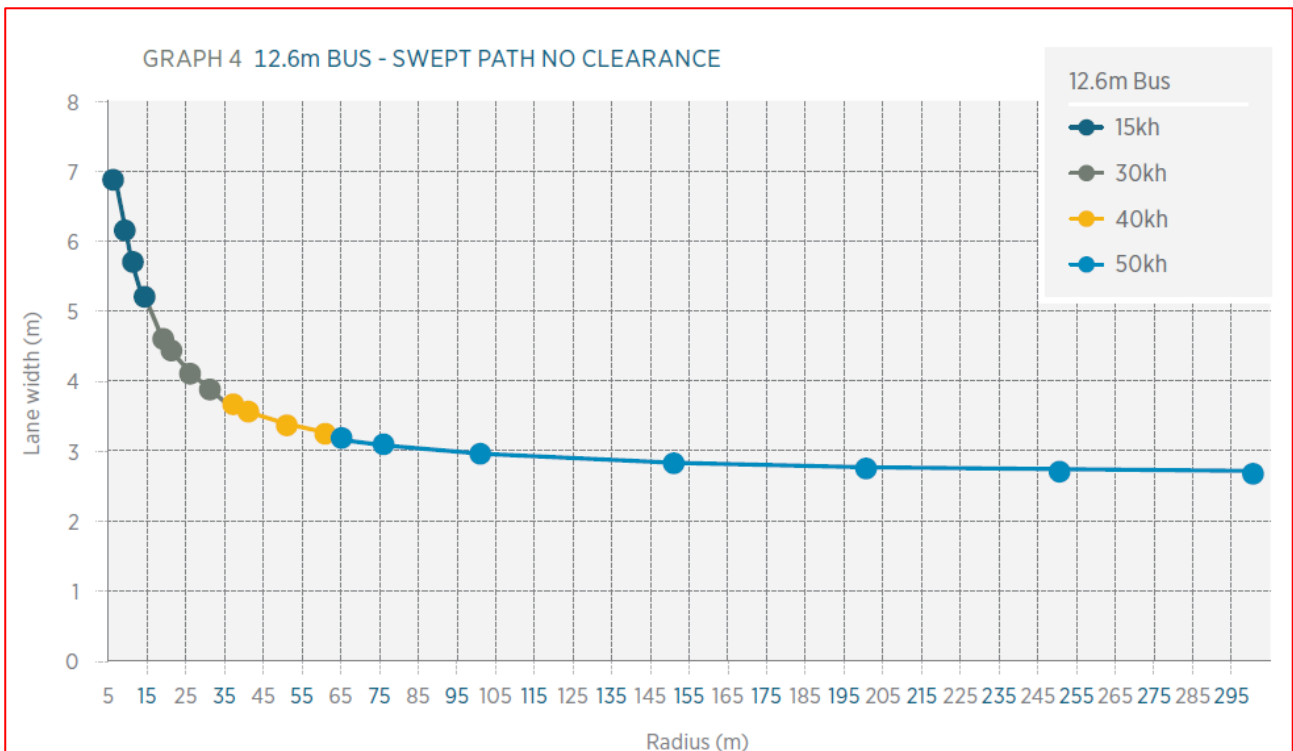
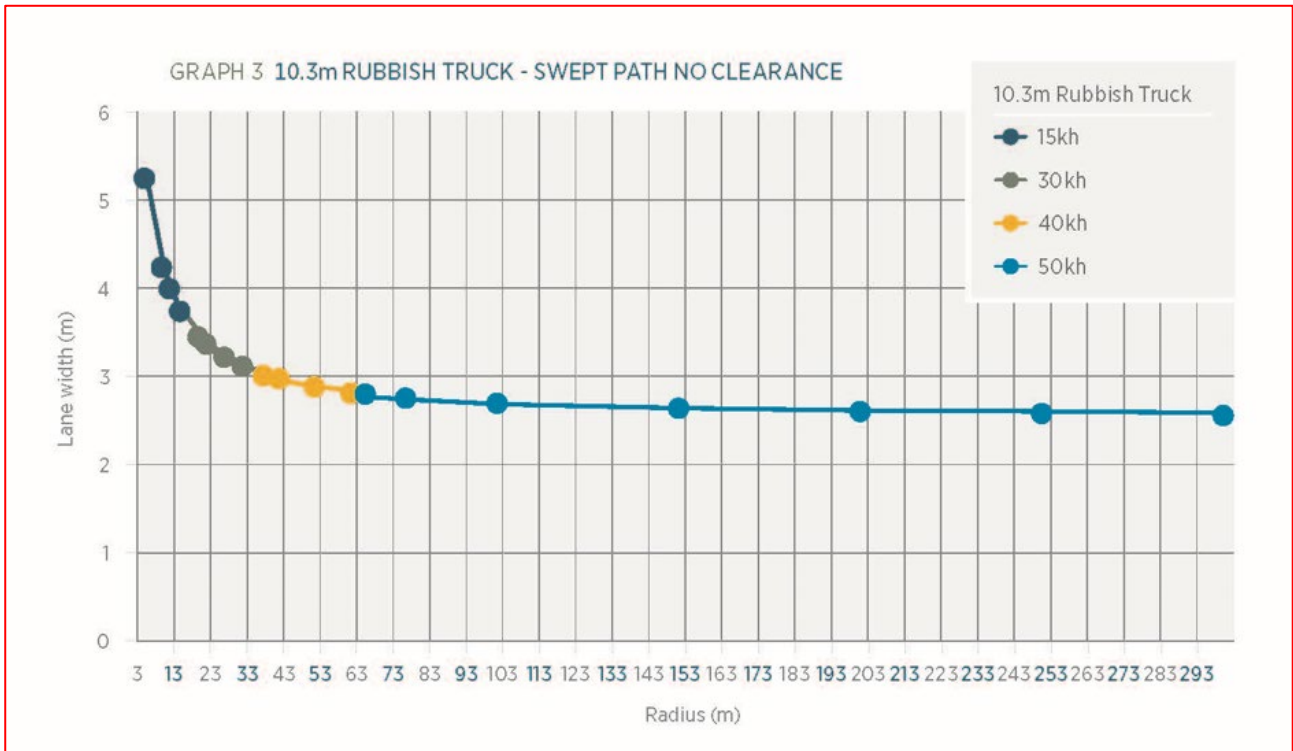

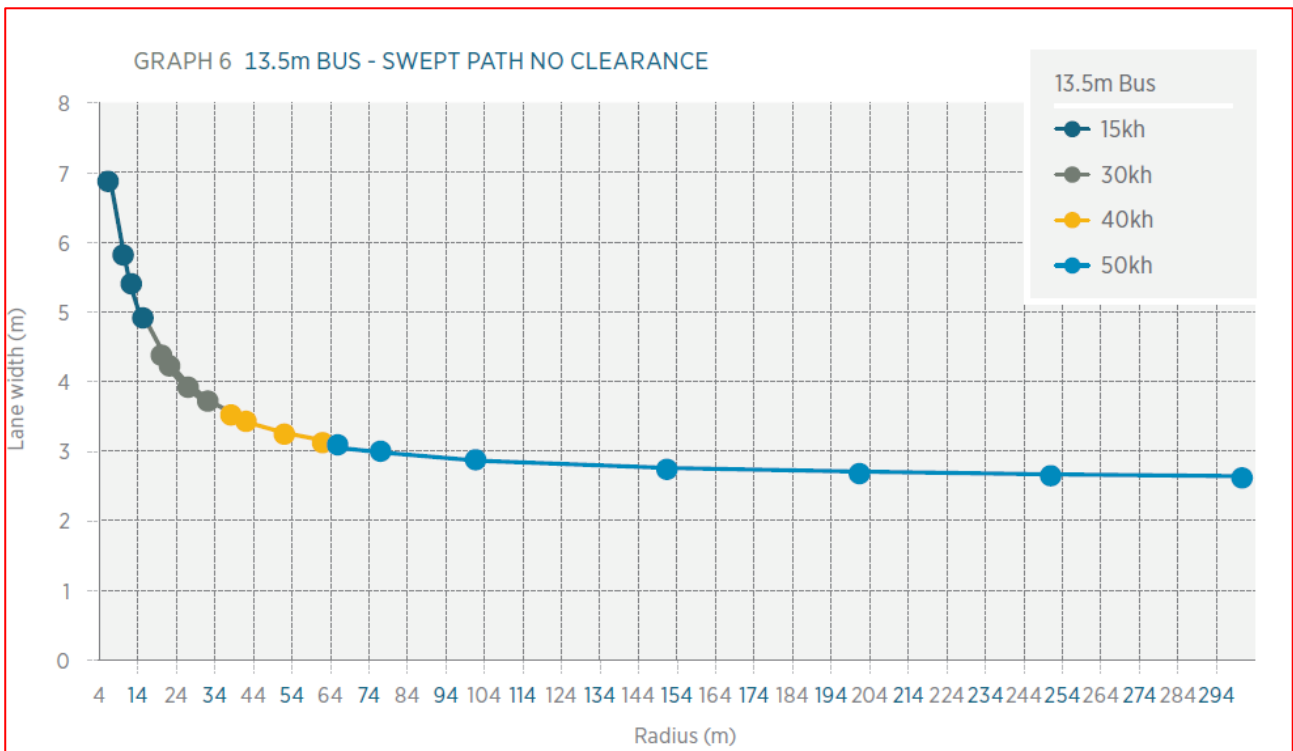
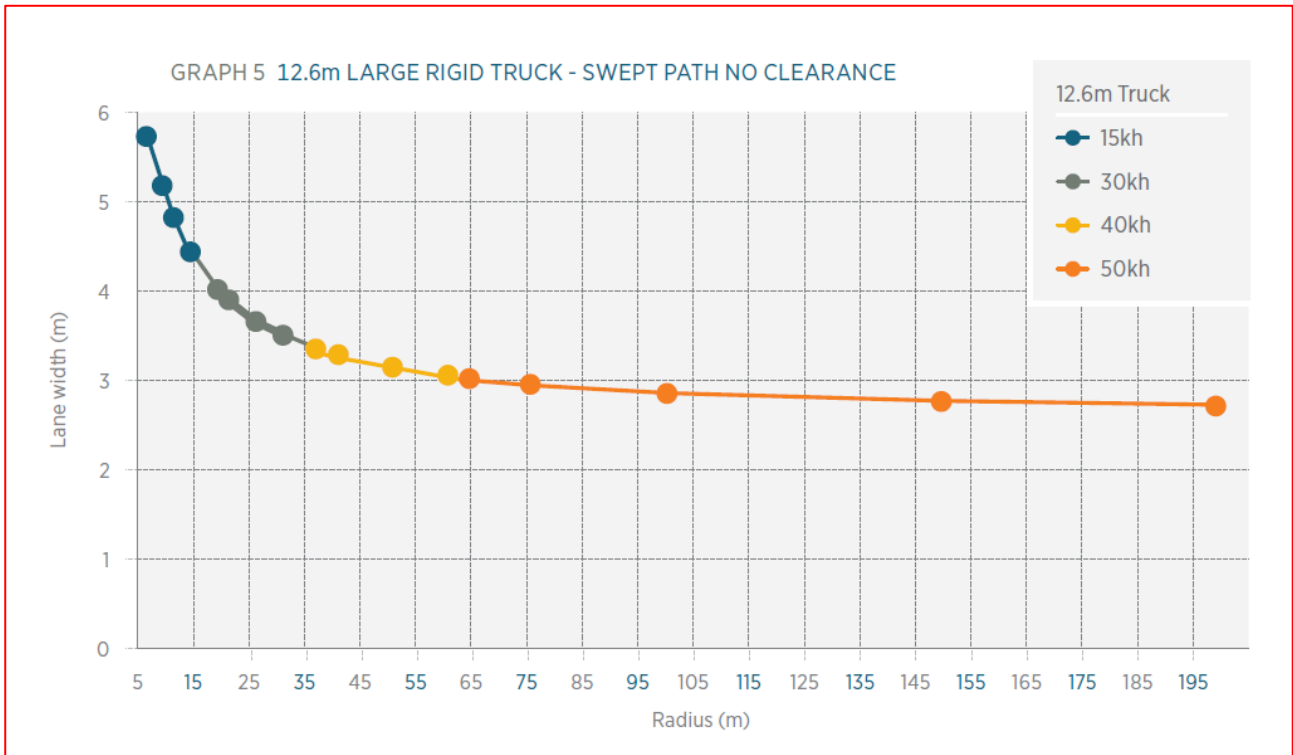

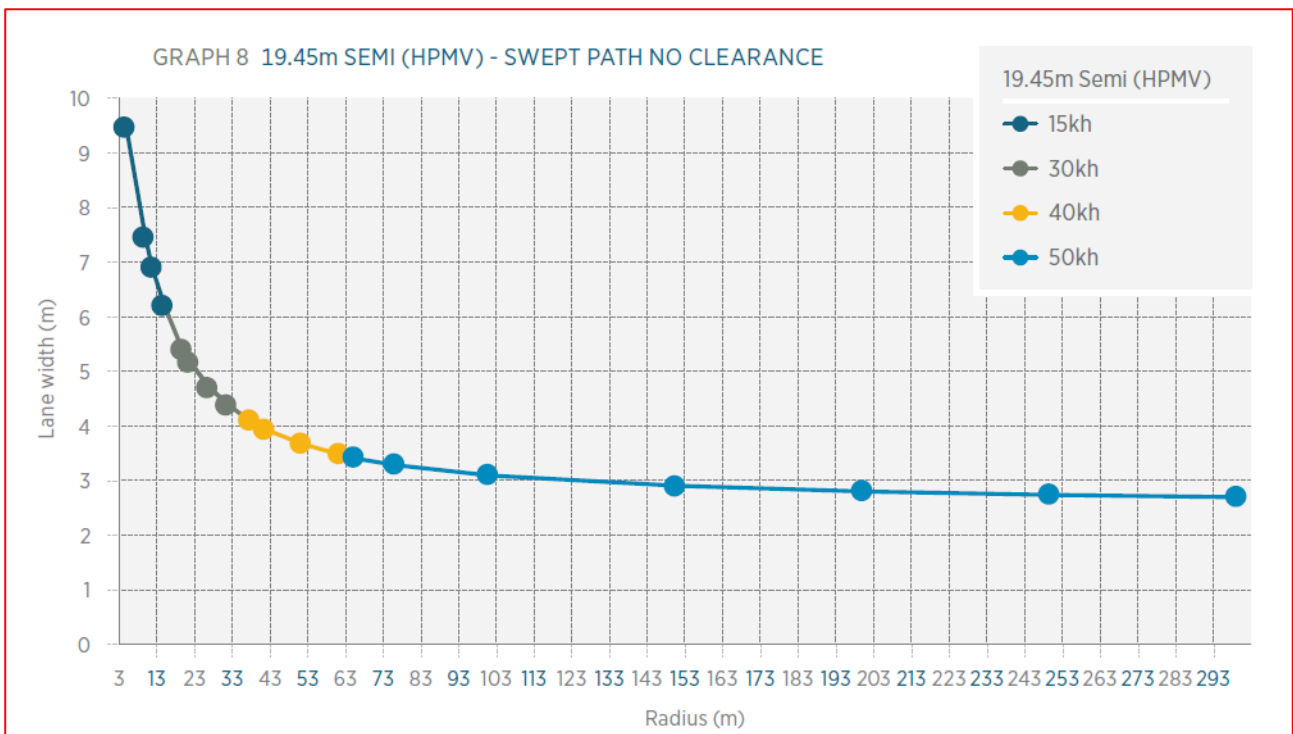
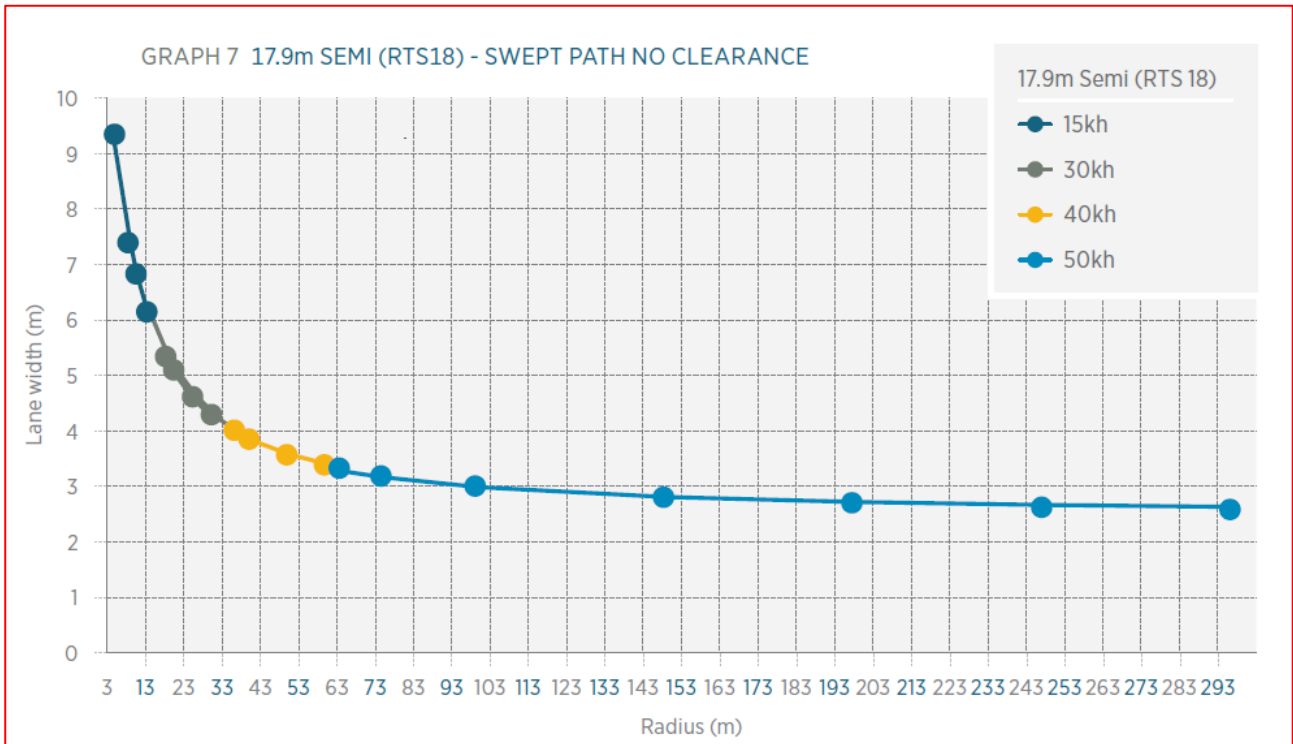

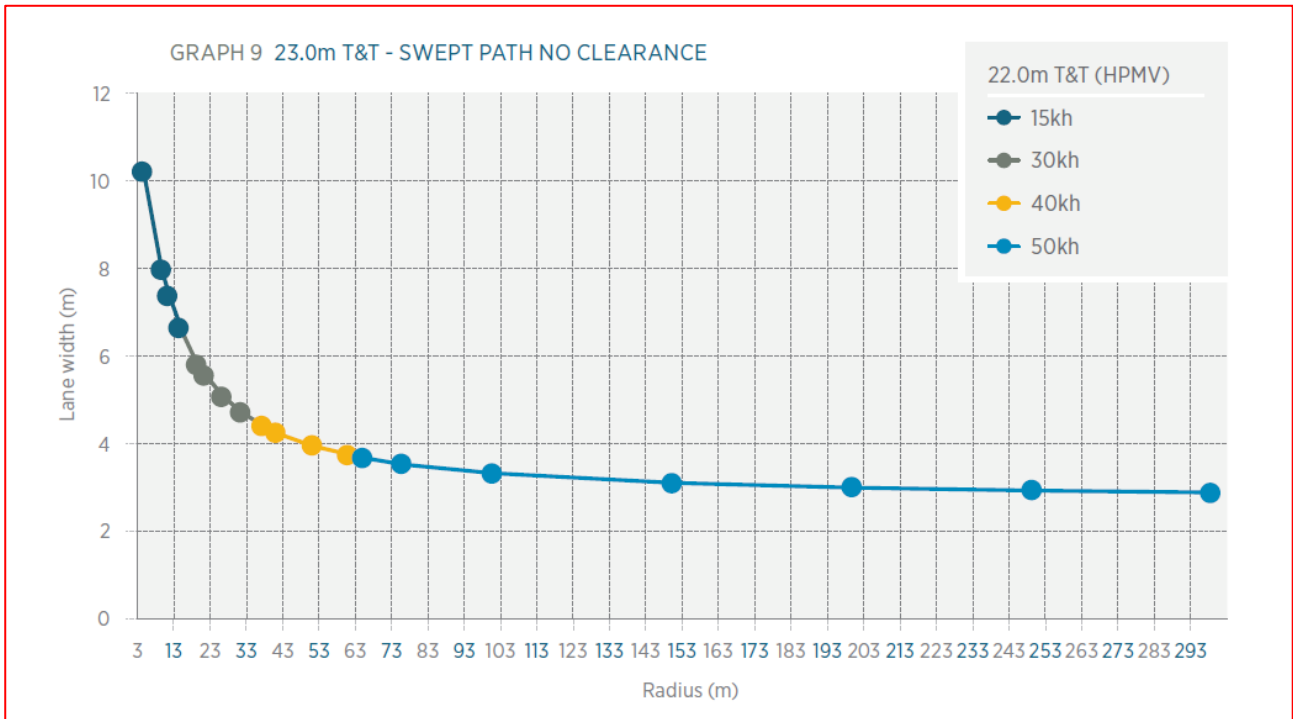

Appendix B: Auckland Transport TDM supporting appendix documents

Appendices referred to in this Section are published in Auckland Transport TDM Supporting appendix documents.	
APPENDIX A	HID Road Lighting Specification
APPENDIX B	LED Road Lighting Luminaire Specification and Assessment Checklist B1 LED Road Lighting Luminaire Specification B2 LED Road Lighting Luminaire Assessment Checklist
APPENDIX C	LED Amenity Lighting Luminaire Specification and Assessment Checklist C1 LED Amenity Lighting Luminaire Specification C2 LED Amenity Lighting Luminaire Assessment Checklist
APPENDIX D	Road Lighting Column Specification, Assessment Methodology and Checklists D1 Road Lighting Column Specification D2 Road Lighting Column Assessment Checklist D3 Road Lighting Column Evaluation Checklist
APPENDIX E	Lighting Design Submission Checklist
APPENDIX F	Road Lighting LED Approved Luminaire List (AT LALL)
APPENDIX G	Amenity Lighting Approved Luminaire List (AT ALAL)
APPENDIX H	Road Lighting Column Approved List (AT LCAL)
APPENDIX J	V and P Category Calculator Tools for Road Classification J1 V Category Calculator Tool J2 P Category Calculator Tool
APPENDIX K	Standard drawings K1 Street lighting electrical connections K2 Street lighting earthing details K3 Traffic Signal Street lighting combination electrical schematic K4 Typical shear base detail

Appendix C: Glossary

Term	Definition
85th percentile	The value at which 85% of the sample is included. Only 15% of the sample will exceed the 85th percentile. In speed sample analysis, 85% of the vehicles surveyed will travel at or below the 85th percentile speed.
Alligator cracking	Also known as chicken wire or block cracking. This type of cracking includes all polygon shaped cracking, irrespective of the size of the polygon.
Alternating flow	The movement of vehicles in alternating opposing directions normally controlled by traffic signals or manual traffic controllers.
Annual average daily traffic (AADT)	The total volume of traffic passing a roadside observation point over the period of a calendar year, divided by the number of days in that year (365 or 366 days). Measured in vehicles per day (vpd).
Approach visibility	<p>For a level crossing:</p> <ul style="list-style-type: none"> • The visibility of a driver approaching a level crossing protected by give way signs needs to be able to either: <ul style="list-style-type: none"> ○ See an oncoming train in time to stop before reaching the level crossing; or ○ Continue at the approach speed and cross the level crossing safely ahead of a previously unseen train or a train far enough away to be clearly not a collision threat. <p>For an intersection:</p> <ul style="list-style-type: none"> • The stopping distance measured from the driver's eye height to pavement level on the approach to an at-grade intersection. <p>For a pedestrian crossing:</p> <ul style="list-style-type: none"> • The safe stopping distance required for any part of pedestrian crossing to be visible.
AS	Australian standard
AS/NZS	Joint Australian and New Zealand standard.
Asset management systems	A system (usually computerised) for collecting analysing and reporting data on the utilization, performance, life cycle management and funding of existing assets.
ASTM	American Society for Testing and Materials.
ATMS	Advanced Traffic Management Systems.
Audio tactile profile (ATP)	An optional component of pavement marking which has raised ribs orientated perpendicular to the longitudinal direction and are closely spaced at regular intervals along or adjacent to the line. They provide a noise (audio) and vibratory (tactile) warning when driven over.
Benefit-cost ratio (B/C)	The sum of the present values of all benefits (including residual value, if any) over a specified period, or the lifecycle of the asset of facility, divided by the sum of the present value of all costs.

Term	Definition
Bi-directional flow	The controlled channelling of traffic flows, usually onto temporary alignments, to maintain traffic flow in both directions. Delineation devices or physical barrier systems are normally used to separate the traffic flows.
Bleeding	The exudation of bituminous binder onto the road surface. A surface that is bleeding is one on which the binder is being picked up on tyres of the passing traffic.
Capital expenditure (CAPEX)	Expenditure used to create new assets or to increase the capacity of existing assets beyond their original design capacity or service potential. CAPEX increases the value of an asset.
CCS	CCS Disability Action Incorporated, the major issuer of disabled parking permits in New Zealand.
Channelised intersection	An intersection provided with medians and islands for defining the trafficable area and to control specific movements.
Channelling	The defining of traffic lanes by use of traffic control devices, separately or in combination.
Chicane	The lateral movement of traffic from one line or one or more lanes onto another alignment before a shift back toward the original road alignment, but not necessarily into the original line, lane or lanes.
Contrast ratio	An objective measure of contrast. For traffic signs this measure is expressed by the formula $(LL - LB) / LB$ where LL is the luminance of the legend and LB is the luminance of the background.
Crown entity	An organisation that forms part of the New Zealand state sector established under the Crown Entities Act 2004 and includes the NZTA.
Deed of grant	A deed or agreement that grants easement of right of way pursuant to a statutory right to grant easements of right of way, for ONTRACK through Section 35 of the New Zealand Railways Corporation Act 1981 or for other operators through common law rights of a landowner.
Depression	A low area in the road surface which is: <ul style="list-style-type: none"> • More than 30 mm deep when measured from a 2 m straight edge placed across the road or • More than 40 mm deep from a 6 m line when measured along the road or • An area that holds water to a depth of 5 mm or greater when the surrounding area is dry.
Design vehicle	For each nominated class of vehicle, the dimensional configuration that represents the characteristics that will encompass the greater number (nominally 99% of the vehicles in the national fleet in that class.
Economic life	The period from the acquisition of the asset to the time when the asset, while physically able to provide a service, ceases to be the lowest cost alternative to satisfy a particular level of service. The economic life is at the maximum when equal to the physical level of service, however obsolescence will often ensure that the economic life is less than the physical life.
Edge break	The fretting or breaking of the edge of a bituminous surface resulting in the seal loss encroaching into the carriageway.
Edge line	A broken or continuous white line marking (or kerb) used to indicate the far left or far right side of the roadway.

Term	Definition
Edge rutting	A deformation of the shoulder such that there is a difference in level between the nominal edge of seal and the adjacent unsealed shoulder.
Engineering exception decision	In relation to a TMP, a written decision made following consideration of all factors, including the safety of all concerned, to vary a code of practice, standard or guideline, to suit a particular situation. The decision must be included with the TMP.
Flangeway	The space next to the rails of a railway line that allows the flanges of the rail vehicle's wheels to pass through a level crossing or other raised areas.
Flare	The deflection of the leading end of a road safety barrier, or channelling device, away from the general alignment of the road and/or direction of traffic flow.
Flare rate	The rate at which a road safety barrier flares away from the general alignment of the road nominally a 1:10 (10 percent) taper.
Flush median	A median marked in accordance with 7.4 (2) of the TCD rule.
Flushing	Where the binder is approaching or above the mean level of the top of the surfacing aggregate and such that the surface texture is lost, and/or water running on the surface drains over the chips rather than through the interstices between them. It should be noted that a surface may be flushed to the extent where the binder is above the surfacing aggregate, but bleeding does not occur.
Frangible	Designed to break away or deform when struck by a motor vehicle, in order to minimise injuries to occupants.
Gantry	A traffic sign assembly in which signs are mounted on an overhead support. Gantries are usually built on high-traffic roads or routes with several lanes, where signs posted on the side of the highway would be hard to see for drivers. Gantries may be cantilevered or one-sided or they may be bridges with two sides.
Geographic Information Systems (GIS)	Software which provides a means of spatially viewing, searching, manipulating, and analysing an electronic database.
Gore area	The paved triangular area between the through lanes, an exit and the exit nose which is defined by two wide solid white lines that guide traffic exiting a motorway or expressway.
Granted level crossing	A level crossing subject to a deed of grant.
Heavy vehicle	For the purposes of traffic rules, a vehicle with a gross vehicle mass exceeding 3,500 kg.
High performance long life (HPLL)	Pavement markings that should be used on smooth surfaced roads for improved skid resistance and wearing properties and better delineation in wet conditions.
Intelligent transport systems (ITS)	A broad range of communications-based information, control, and electronics technologies integrated into the transportation system infrastructure, and in vehicles, to help monitor and manage traffic flow, reduce congestion, provide alternate routes to travellers, enhance productivity, and save lives, time, and money.

Term	Definition
Isolated cracking	This type of cracking includes all longitudinal transverse and diagonal cracks as well as large rectangular cracks that are to be treated separately. It also includes cracking between the channel and edge of pavement.
Level 3 road	For the purposes of Part 8 (CoPTTM), a high-volume, high-speed, multilane road or motorway road with AADT greater than 10,000 vpd.
Life	A measure of the anticipated life of an asset or component; such as time, number of cycles, distance intervals etc.
Life cycle	Life cycle has two meanings: <ul style="list-style-type: none"> • The cycle of activities that an asset (or facility) goes through while it retains an identity as a particular asset, i.e. from planning and design to decommissioning or disposal. • The period of time between a selected date and the last year, over which the criteria (e.g. costs) relating to a decision or alternative under study will be accessed.
Life cycle cost	The total of an asset throughout its life including planning, design, construction, acquisition, operation, maintenance, rehabilitation and disposal costs.
Lifecycle cost analysis	Any technique which allows assessment of a given solution, or choice from among alternative solutions, on the basis of all relevant economic consequences over the service life of the asset.
LRS	See Temporary Traffic Management for Local Roads Supplement to NZTA CoPTTM.
LTMA	Land Transport Management Act 2003.
Luminance	Luminance is a measure of the luminous intensity per unit area of light travelling in a given direction. The luminance indicates how much luminous power will be perceived by someone looking at the surface from a particular angle of view and is thus an indicator of how bright the surface will appear.
Maintenance standards	The standards set for the maintenance service such as preventative maintenance schedules, operation and maintenance manuals, codes of practice, estimating criteria, statutory regulations and mandatory requirements in accordance with maintenance quality objectives.
Makeup metal	The supply and application of GAP 40 or GAP 65 maintenance aggregate typically applied to the road surface to shape correct and/or strengthen the pavement
MOTSAM	Manual of traffic signs and markings, Transit New Zealand and Land Transport New Zealand.
Net present value (NPV)	The value of an asset to the organisation, derived from the continued use and subsequent disposal in present monetary values. It is the net amount of discounted total cash inflows arising from the continued use and subsequent disposal of the asset after deducting the value of the discounted total cash outflows.
Notice of non-conformance	An instruction in writing to the traffic management supervisor or contractor to advise them that traffic management measures do not comply with the approved Traffic Management Plan (TMP), or the actions of the site traffic management supervisor do not comply with the requirements of Part 8 (CoPTTM).

Term	Definition
NZ Transport Agency (NZTA)	A New Zealand Crown entity created by the merger of Land Transport New Zealand and Transit New Zealand on 1 August 2008. Also referred to as 'the NZTA' or 'the Agency'.
O.D.	Outside diameter.
Operating speed	The 85th percentile speed of vehicles on a section of a road or, for the purposes of TCD Manual Part 8 (CoPTTM) the operating speed as declared by the RCA.
Over-dimension vehicle	A motor vehicle or combination vehicle (including any load) that exceeds one or more of the dimension limits outlined in section 4 of the Land Transport Rule: Vehicle Dimensions and Mass 2002.
Performance indicator	A qualitative or quantitative measure of a service or activity used to compare actual outcome against a standard or other target. Performance indicators commonly relate to statutory limits, safety, responsiveness, cost, comfort, asset performance, reliability, efficiency, environmental protection and customer satisfaction.
RMA	Resource Management Act 1991.
Road Asset Maintenance Management System (RAMM)	The computerised road maintenance management software system developed by Transit New Zealand for use nationally by all New Zealand road asset managers.
Road Controlling Authority (RCA)	In relation to a road: <ul style="list-style-type: none"> • The authority, body or person having control of the road • Includes a person acting under and within the terms of a delegation or authorisation given by the controlling authority.
Road Controlling Authority Forum (RCA Forum)	A closed, non-political group with representatives from the territorial local authorities, the Department of Conservation, NZ Transport Agency and Local Government New Zealand.
RSMA	Road Safety Manufacturers Association.
RSMA compliance standard	RSMA Compliance standard for traffic signs 2008.
Safe stopping distance (SSD)	The minimum distance required for a driver of normal vision travelling at a safe operating speed for the road to recognise a hazard and decelerate with normal braking to stop completely before reaching the hazard.
Scabbing	This is the progressive loss of chip from the seal coat and includes loss of chip alongside the kerb and channel.
Should	Indicates a recommendation.
SHRM	State Highway Route Marker.
Shy line	The distance from a hazard beyond which a typical road user will not perceive it as an immediate danger so they will not normally change their vehicle's speed or placement.

Term	Definition
Side friction	<ul style="list-style-type: none"> The retarding effect on the free flow of traffic caused by interference of any sort at either edge of a carriageway or traffic lane, other than at an intersection. In relation to road works, it is a form of positive traffic management that uses delineation devices placed close to a live lane, to give road users the impression they are travelling in a more restrictive width than they actually are. Friction force acting on a vehicle during cornering.
Sight distance	The distance over which a road user must have unobstructed sight to respond to a visual cue, or safely avoid a conflict.
Site traffic management supervisor (STMS)	A NZTA qualified person who has specific responsibility for documentation and management of temporary traffic management (TTM).
Slippage cracks	Occurs only in thin asphaltic concrete wearing courses. They are usually crescent shaped and point in the direction of the thrust of the wheels on the pavement.
Slippery surface	Usually caused by underlying clay subgrade materials or clay/aggregate mixes on the trafficable carriageway surface.
State highway	<p>A road, whether or not constructed or vested in the Crown, that is declared to be a State highway under Section 11 of the National Roads Act 1953, Section 60 of the Government Roadway Powers Act 1989, or under Section 103 of the Land Transport Management Act 2003 and includes:</p> <ul style="list-style-type: none"> All land along or contiguous with its route that is the road; and Any part of an intersection that is within the route of the State highway; and For the purposes of regional land transport programmes, the national land transport programme, and any expenditures approved under Section 20 by the Agency, a proposed State highway.
Stripping	For the purpose of this document stripping means displacement of binder from the chip.
Supplementary destination sign (SDS)	A sign, usually ground mounted, that may be used to provide information regarding destinations accessible from an interchange, other than places shown on the standard interchange signing.
TCD rule	Land Transport Rule: Traffic Control Devices 2004, including any subsequent amendments.
TCD specifications	Land Transport NZ Traffic control devices specifications – a collective term to cover the sign specifications, signal specifications and marking specifications parts of the TCD Manual
TSL	Temporary speed limit.
TTM	Temporary traffic management.
TLA	Territorial Local Authority A district council, city council or county council (as defined by the Local Government Act 2002).
TCD	Traffic control device
Traffic controller (TC)	An NZTA qualified person who has specific responsibility to manage a worksite on a level 1 road.

Term	Definition
Traffic management coordinator (TMC)	A person, or position, in an organisation that has the delegated authority from an RCA to approve TMPs, coordinate TTM and, where appropriate for local roads, to delegate power to approve TMPs to others.
Traffic management plan	A document describing the design, implementation, maintenance and removal of TTM while the associated activity is being carried out within the road reserve or adjacent to and affecting the road reserve.
Truck mounted attenuator (TMA)	A safety device fitted to the rear of a vehicle that collapses when impacted by another vehicle.
URM	Urban route marker.
Variable message sign (VMS)	An electronic sign in which the message can be changed in form, shape, layout, colour and any other manner. Such signs may be illuminated or otherwise.
VPD	Vehicles per day.
VPH	Vehicles per hour.
Zone restriction	An area of roadway the use of which is restricted to a specified class or classes of vehicle or class or classes of road user (with or without a time restriction).

Appendix D: Relevant documents

Auckland Council

- Auckland Unitary Plan, 2016
- Auckland Design Manual
 - Bioretention design guide, 2021

Auckland Council Bylaws

- Stormwater Bylaw, 2015
- Trading and Events in Public Places Bylaw, 2015

Auckland Council: Codes of Practice

Auckland Council Code of Practice. (2016). Land Development and Subdivision Chapter 1: *General Requirements*

Watercare Services (2017). Water and Wastewater Code of Practice for Land Development and Subdivision *Chapter 5: Wastewater* (Part of Auckland Code of Practice for Land Development and Subdivision)

Auckland Council Code of Practice. (2021). Land Development and Subdivision Chapter 7: *Landscape*

Auckland Council Code of Practice. (2022). Land Development and Subdivision Chapter 4: *Stormwater*

Auckland Council: Guideline Documents

Auckland Council guideline document GD2015/004 *Water sensitive design for stormwater*. Guideline document GD04

Auckland Council guideline document GD2017/001 *Stormwater management devices in the Auckland region*. Guideline document GD01

Auckland Council: Technical Reports

Auckland Regional Council. (1999). *Guidelines for stormwater runoff modelling in the Auckland region*. Technical Report TP108.

Auckland Regional Council. (2009). *Fish passage in the Auckland region*. Technical Report TR2009/084

Auckland Council. (2013). *Stormwater disposal via soakage in the Auckland region*. Technical Report TR2013/040.

Auckland Council. (2013). *Hydraulic energy management: Inlet and outlet design for treatment devices*. Technical Report TR2013/018

Auckland Council. (2016). *Coastal inundation by storm-tides and waves in the Auckland region*. Technical Report TR2016/017

Auckland Transport

Any documents not available from <https://at.govt.nz/about-us/> may be obtained by direct application to Auckland Transport.

- Auckland Transport Code of Practice (2013) *Chapter 16: Road pavements and surfacings*
- Guidelines for the selection of pedestrian facilities
- Roads and streets framework
- Transport Design Manual (TDM)
 - Engineering Design Codes
 - Standard Engineering Details
 - Specifications
 - Urban Street and Road Design Guide
 - Wayfinding and Signs Design Guide Version 1
 - Waitakere Ranges Design Guide
- Other specifications:
 - Street Lighting Design Code Appendix B: LED Road Lighting Luminaire Specification Appendix B
 - ECS Electrical Cable Specification, 2000
 - ESE 406 – Overhead Standard – Structures with street lights

Auckland Traffic Management Unit

- Traffic Signals Design Guidelines Version 4.2 August 2017

Austrroads

- Guide to Road Design 2010:
 - Part 1 Introduction to Road Design (GRD1)
 - Part 2 Design Considerations (GRD2)
 - Part 3 Geometric Design (GRD3)
 - Part 4 Intersections and Crossings - General
 - Part 4A: Unsignalised and Signalised Intersections (GRD4A)
 - Part 4B Roundabouts (GRD4B)
 - Part 4C: Interchanges.
 - Part 5: Drainage – General and Hydrology Considerations
 - Part 5A: Drainage: Road Surface, Networks, Basins and Subsurface
 - Part 5B: Drainage-Open Channels, Culverts and Floodways
 - Part 6: Drainage-Open Channels, Culverts and Floodways
 - Part 6A: Pedestrian and Cyclist Paths

- Guide to Traffic Management
 - Part 6: Intersections, Interchanges and Crossings
 - Part 8: Local Street Management
- Cycling Aspects of Austroads Guides (2017 Edition)
- AP-R481-15: Safety Provisions for Floodways Over Roads, 2015

Ministry of Transport

Land Transport Rule: Traffic Control Devices

NZ Transport Agency

- Guidelines for Marking Multi-lane Roundabouts
- Bridge Manual, SP/M/022, 2013
- Geometric Design Manual
- Manual of Traffic Signs and Markings (MOTSAM), 2010
- Cycling Network Guidance (online publication)
- Pedestrian Network Guidance: 2021 (online publication) superseding NZTA Pedestrian Planning and Design Guide, 2009
- Pedestrian Planning and Design Guide, 2009
- Road safety audit procedures for projects
- Road and traffic standards series (RTS)
 - RTS 1: Control at Crossroads, 2001
 - RTS 5: Guidelines for rural road marking and delineation, 2002
 - RTS 11: Urban Roadside Barriers and Alternative Treatments, 2001
 - RTS 14: Guidelines for facilities for blind and vision-impaired pedestrians, 2008
 - RTS 18: New Zealand on-road tracking curves for heavy vehicles, 2007
- Specifications:
 - M/17P Specification for W-section bridge guardrail, 1989
 - M23: Specification for road safety barrier systems, 2009
 - M30: Specification and guidelines for road lighting design, 2014
 - National Traffic Signal Specification, Revision 3, 2012
- Standards Section 3: Approval of Road Safety Barrier Systems for road safety.
- State Highway Geometric Design Manual
 - State Highway Geometric Design Manual Part 6, Section 6.5 *The Clear Zone*, 2002.

Standards Australia

- AS 1111.1: 2015 ISO metric hexagon bolts and screws: Product grade C, Part 1: Bolts
- AS 1112.3: 2015 ISO metric hexagon nuts

Standards New Zealand

- AS/NZS 1158: Lighting for roads and public spaces
- AS/NZS 1158.1.1:2005 Lighting for roads and public spaces - Part 1.1: Vehicular traffic (Category V) lighting
- AS/NZS 1158.1.2:2010 Lighting for roads and public spaces - Part 1.1: Vehicular traffic (Category V) lighting,
- AS/NZS 1158.3.1:2020 Lighting for roads and public spaces, Part 3.1: Pedestrian area (Category P) lighting,
- AS/NZS 1158.4:2009 Road lighting - Lighting of pedestrian crossings
- SA/SNZ TS 1158.6:2015 Lighting for roads and public spaces - Part 6: Luminaires – Performance
- AS/NZS 1163:2016 Cold-formed structural steel hollow sections
- AS/NZS 1428.4.1: Design for access and mobility - Part 4.1: Means to assist the orientation of people with vision impairment - Tactile ground surface indicators
- AS/NZS: 1554.5:1995 Structural steel welding - Welding of steel structures subject to high levels of fatigue loading
- AS/NZS 2633:1966 Guide to the specification of colours
- NZS/AS 3000:2018 Electrical installations - Known as the Australian/New Zealand wiring rules
- NZS 3109:1997 Concrete construction
- AS/NZS 3114:1987 Specification for concrete surface finishes
- AS/NZS 3116:2002 Concrete segmental and flagstone paving
- NZS 3631:1988 New Zealand timber grading rules
- AS/NZS 3661.1:1993 Slip resistance of pedestrian surfaces
- AS/NZS 3661.2:1994 Slip resistance of pedestrian surfaces – guide to the reduction of slip hazards
- AS/NZS 3845:1999 Road safety barrier systems
- NZS 4121:2001 Design for access and mobility: Buildings and associated facilities
- NZS 4223:2016 Part 3: Glazing in buildings - Part 3: Human impact safety requirements
- AS/NZS 4282:2019 Control of the obtrusive effects of lighting
- AS/NZS 4586:2004 Slip resistance classification of new pedestrian surface materials: Amendment 1
- AS/NZS 60598.1:2017 Luminaires - Part 1: General requirements and tests
- AS/NZS 60598.2.3:2015 Electrical installations - Known as the Australian/New Zealand wiring rules

- AS/NZS 7000:2016 Overhead line design
- NZS 3640:2003 Chemical preservation of round and sawn timber
- AS/NZS/BS 4848:1991 3679.1:2010 Structural steel - Part 1: Hot-rolled structural steel bars and sections

NZ Legislation

- Building Act, 2004
- Electricity Act, 1992
- Fencing Act, 1978
- Health and Safety at Work Act, 2015
- Local Government Act (1974 and more recent updates)
- New Zealand Building Code
- Resource Management Act, 1991
- Waitakere Ranges Heritage Area Act (2008)

Other publications

Alderson, A 2006, *The collection and discharge of storm water from the road infrastructure*, report no. ARR 368, ARRB Group, Vermont South, Vic.

Department of Natural Resources and Water 2007a, *Queensland urban drainage manual*, vol. 1, 2nd edn, DNRW, Brisbane, Qld.

American Association of State Highway and Transportation Officials (AASHTO). (2011). *Roadside design guide*, 4th Edition

American National Standards Institute: ANSI C136 4:2013 *Roadway and area lighting equipment dimming control*

Auckland Utility Operators Group. (2013). *Code of practice for working on the road*

City of Melbourne: *Outdoor café guide*

Ministry of Business Innovation and Employment. (2019). *New Zealand cycle trail design guide*. 5th Edition

Ministry for the Environment. Bell, R. J. S. P., Lawrence, J., Allan, S., Blackett, P., Stephens, S., Hannah, J., ... & Davies, K. (2017). *Coastal hazards and climate change: guidance for local government*.

Ministry for the Environment. (2020). *National policy statement for freshwater management, 2020*

Ministry of Justice: National Guidelines for Crime Prevention through Environmental Design in New Zealand, 2005
<https://www.justice.govt.nz/assets/Documents/Publications/cpted-part-1.pdf>

National Cooperative Highway Research Program. (1993). NCHRP Report 350: *Recommended Procedures for the Safety Performance Evaluation of Highway Features*

New South Wales Government. (2005). *Floodplain development manual – the management of flood liable land*

New Zealand Heavy Haulage Association. (2017). *Road design specifications for over-dimensional loads*